

SUN EXPERT

An Independent Forum for Open Systems

NOVEMBER 1991 Vol. 2 Num. 11 \$4.50

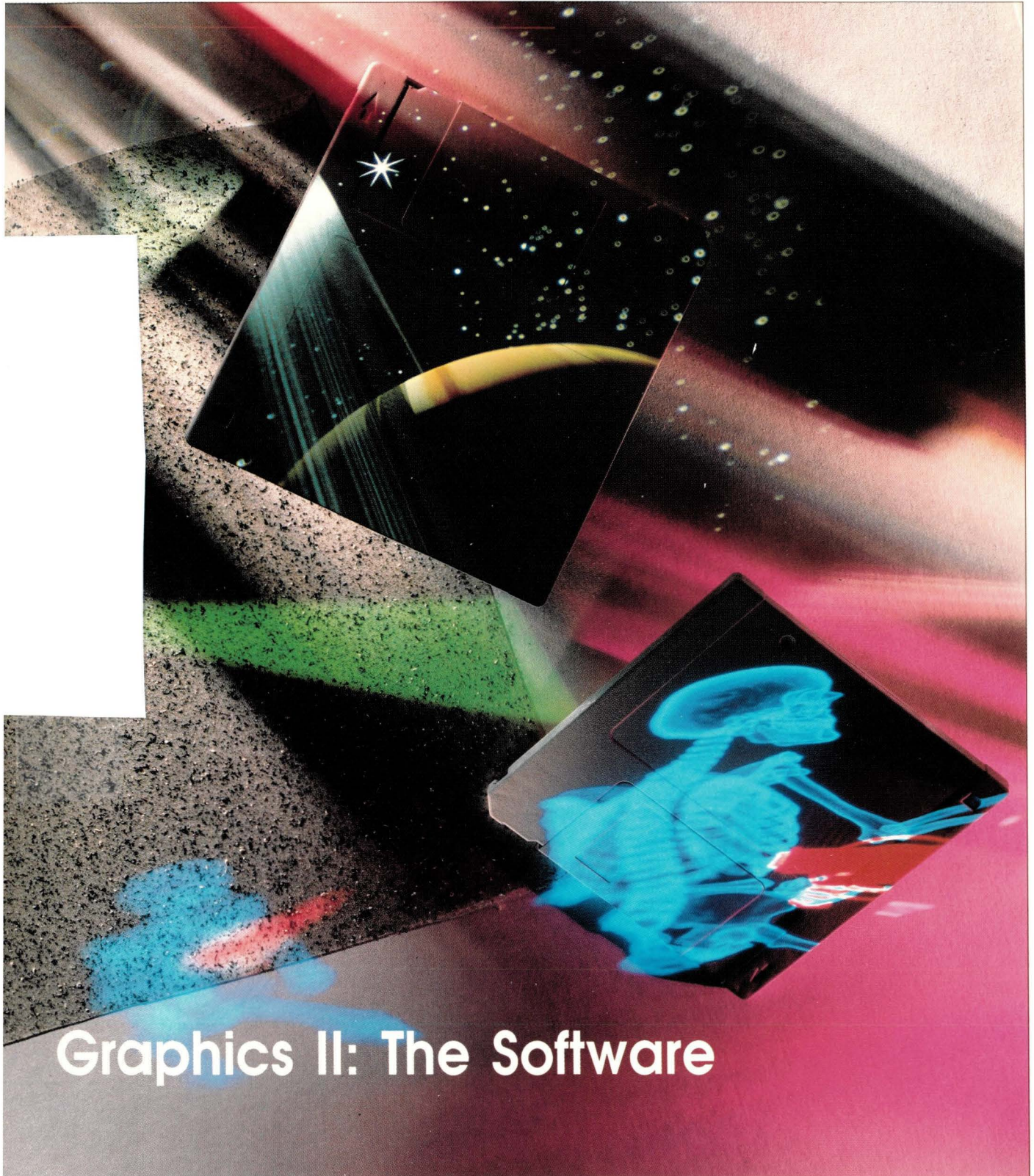

Graphics II: The Software

News: Galaxy, Solaris

Island Productivity Series

What'll we think of next?

True to our legacy, we're committed to designing and building leading-edge solutions that make it easier than ever to get your work done.

But being able to upgrade from the old to the new is just as important. And that's why we're forging clear migration paths to the next generation of computing.

Sun offers the only RISC/UNIX® platform with upgradability designed in. So wherever we go,

you're assured of compatibility in data, applications, and environment. Which maximizes the potential of your existing investment.

For more information on the Sun Upgrades Program, contact your nearest sales office. In the

United States, call 1-800-821-4643 (in California, call 1-800-821-4642).

You'll discover that even before we think about what's coming next, we're thinking about you.

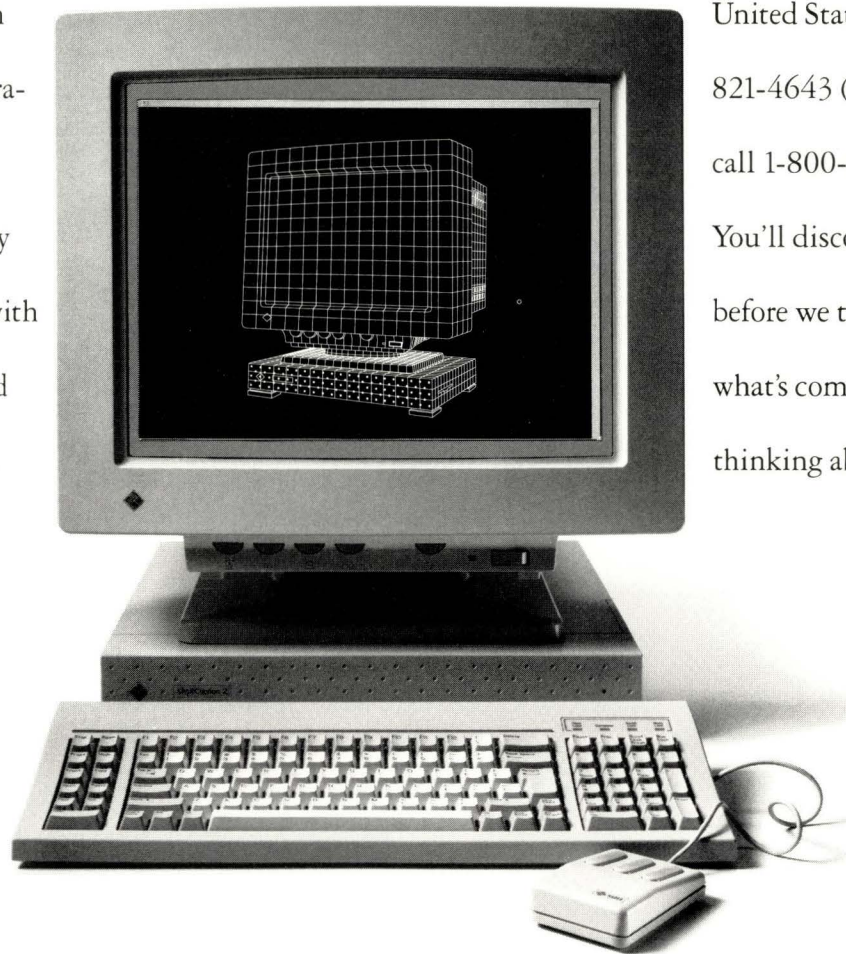

© 1991 Sun Microsystems, Inc. Sun Microsystems and the Sun logo are registered trademarks of Sun Microsystems, Inc. UNIX is a registered trademark of UNIX System Laboratories, Inc.

Circle No. 38 on Inquiry Card

TK olver Plus

"...a designer's dream."

Now Available on OSF/Motif™

Ready for Immediate Shipment

Solve Design and Analysis Problems Using TK Solver Technology from UTS.

Choose the Tool Kit (TK) that engineers, scientists, educators and financial analysts have used since 1983. TK Solver lets you set up and solve problems up to 100 times faster than any other method. Just enter the equation, input what you know and TK Solver gives you the results—forward or backward.

Select from a variety of models, or build and store your own. Basic enough for beginners with the power to please the experts. So release your creativity—**your designer genes**—and turn over the problem solving to TK Solver.

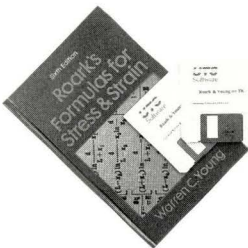

ROARK & YOUNG on TK

The entire sixth edition of *Roark's Formulas for Stress & Strain* is now computerized using TK Solver. Point and shoot menu makes it easy to use. Plots of deflection and cross-section make it easy to view the results. What took hours, now takes seconds!

"... a designer's dream." —Professor Warren C. Young

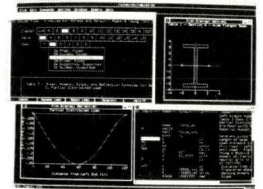

HEAT TRANSFER on TK

A big time saver. A powerful tool useful to virtually every practicing engineer. Covers all the topics in *Fundamentals of Heat and Mass Transfer*. Over 200 TK Solver-based models help you solve problems in conduction, convection, radiation, multimode heat transfer, heat exchangers, etc.

A big time saver.

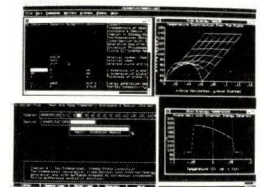

GEAR ANALYSIS on TK

Well-proven. Practical. Fast. Widely used. Just a few of the words which describe this expert system software. Solve real life problems such as noise reduction, increasing life, reducing weight/cost, tooling design, design of plastic and powdered metal gears and molds... and more.

Save design time by 80%. Cut product costs up to 40%.

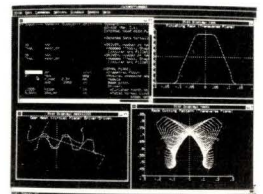

TK Solver and its applications are available on PC, Mac®, VAX™ and UNIX® workstations.

Call for your free copy of MiniTK!

MiniTK, which can solve up to 24 simultaneous equations with up to 32 variables, is a subset of TK Solver.

"For \$20, MiniTK is one of the best bargains on the planet."

Dr. Stephen A. Benton, Director, Spatial Imaging Group, MIT



UTS Software

Universal Technical Systems, Inc.
1220 Rock Street, Rockford, IL 61101, USA
Tel: 815-963-2220 Fax: 815-963-8884
Toll Free: 1-800-435-7887

Universal Technical Software (UK) Ltd.
27 Corsham Street, London, N1 6UA, UK
Tel: 44(071) 490-5151 Fax: 44(071) 490-2701
UTS (UK) is an affiliate of ESDU International plc

Hakuto Co., Ltd.
1-13, Shinjuku 1-Home
Shinjuku-ku, Tokyo 160, Japan
03-3225-8910 Fax: 03-2115-9007

OSF/Motif is a trademark of the Open Software Foundation, Inc. Macintosh is a registered trademark of Apple Computer, Inc. VAX is a trademark of Digital Equipment Corporation. UNIX is a registered trademark of UNIX System Laboratories, Inc.

Circle No. 46 on Inquiry Card

Beyond The Limits.



The first optical storage system to offer one terabyte on-line

R Squared introduces the IFS-1200 Optical Storage Library, giving you access to over one terabyte of stored data in 6.5 seconds! The newest member of the R Squared INFINITY Series, the IFS-1200 is the industry's most capacious system with one of the world's smallest footprints per megabyte.

The IFS-1200 can operate completely unattended, is fully automated with a double-headed picking mechanism designed and manufactured by Kodak, and sustains a 1.0 MB/sec data transfer rate and 4.0 MB/sec burst rate.

When integrated with R Squared's INFINITY software, the system has the ability to span multiple volumes and track files inside and outside the unit.

TEST INFINITY'S LIMITS! Call R Squared to speak with a technical sales representative and receive a complete information packet. 1-303-790-6090 or fax 1-303-799-9297.

R SQUARED
for Systems Solutions

11211 East Arapahoe Road / Englewood, Colorado 80112 / 800-777-3478 / 303-799-9292 / Fax 303-799-9297

Fremont, CA 415-438-0800 / Irvine, CA 714-837-0960 / Kansas City, KS 913-764-0707
Salt Lake City, UT 801-595-0631 / San Diego, CA 619-484-5668 / Seattle, WA 206-883-3116

Circle No. 34 on Inquiry Card

FEATURES

- 54 **Graphics II: The Software**—Suns are not supposed to be graphics boxes. Yet, they are increasingly a favorite of graphics ISVs.
Michael Jay Tucker
- 66 **That's Entertainment**—Among the most demanding applications of computer graphics are film and video. Even here, SPARC-based systems are finding a role.
Michael Jay Tucker
- 73 **An Island in the Sun**—Full-color text and graphical editing, along with a reasonably sophisticated text processor, make IslandWrite, Draw and Paint a powerful document mill.
Barry Shein

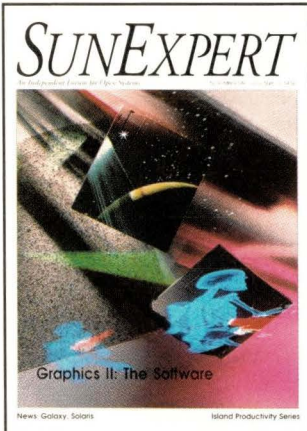

Cover Photograph
by Logan Seale

NEWS

- 10 Includes: **Galaxy Multiprocessors (Finally) Make Their Debut, Solaris Also Rises, Need Small Stuff Fast?, X11R5 Hits the Servers**

COLUMNS

- 22 **Ask Mr. Protocol – The Other X: International Cooperation and Its Horrors**—What is it then, this thing called OSI?
Michael O'Brien
- 28 **UNIX Basics – Program Arguments**—These days, most programmers will use the getopt routine to decode arguments.
Peter Collinson
- 40 **I/Opener – A Look at Software Distribution**—From freeware to pay-as-you-go schemes, the issue of distribution remains a thicket.
Richard Morin
- 44 **Your Standard Column – FORTRAN? Yes, FORTRAN**—If all goes well, there might be a standard by December.
Peter H. Salus
- 46 **Systems Administration – Imake: Friend or Foe?**—If you support X, chances are you will have to deal with imake every day.
Dinah McNutt

DEPARTMENTS

- 4 Editorial
6 Letters
36 Reader Feedback
79 New Products
89 Reader Inquiry Card
91 Subscription Card

SUNEXPERT

serves the UNIX workstation environment, emphasizing Sun, SPARC and Sun-compatible systems.

SUNEXPERT Magazine (ISSN 1053-9239) is published monthly by Computer Publishing Group, 1330 Beacon St., Brookline, MA 02146. Telephone (617) 739-7001. Second-class Postage Rates paid at Boston, MA, and at additional mailing offices. This publication is free to qualified subscribers as determined by the publisher. Subscription rates are \$49.50 per year in the United States, and \$70.00 abroad. Subscription requests can be sent to: Circulation Department, SUNEXPERT Magazine, 1330 Beacon St., Brookline, MA 02146 or electronically mailed to circ@expert.com.
POSTMASTER, please send all address changes to SUNEXPERT Magazine, Circulation Department, 1330 Beacon St., Brookline, MA 02146. Please allow 6-8 weeks for change of address. Include your old address as well as new—enclosing, if possible, an address label from a recent issue. All rights reserved. © Copyright 1991, Computer Publishing Group. No part of this publication may be transmitted or reproduced in any form by any means without permission in writing from the publisher. Material for publication should be sent to the attention of: Doug Pryor at the above address or electronically mailed to dpryor@expert.com. Letters sent to this publication become the property of the publication and are assumed to be intended for publication and may be used so. SUNEXPERT Magazine is not sponsored or endorsed in any way by Sun Microsystems Inc. All information herein is believed to be accurate to the best of our ability.

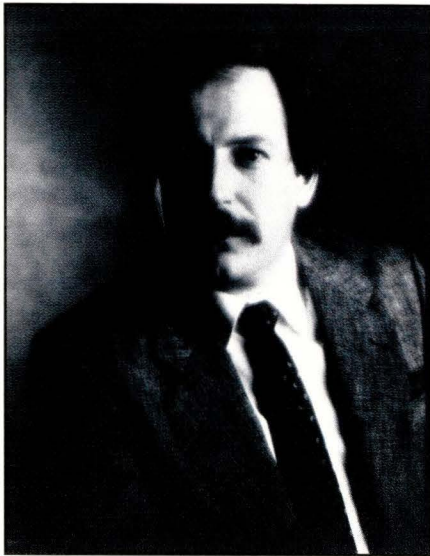

Editorial

MIRVing the Arrowhead

Well, it seems the arrowhead is now a MIRV (McNealy's Intel Reclamation Vehicle). The mass-market Intel 80X86 family has joined SPARC, UNIX and Open Look on the arrowhead. How many standards can you fit on the head of an arrow? Or, better yet, how many companies can you name that were once Sun Microsystems Inc.? If you have any theories about how recent Sun flare ups and expansion might impact you, pass them along to me at dpryor@expert.com. Perhaps, we can come up with a unified theory that we can test at the Sun User Group Conference and Exhibition in San Jose, December 8 through 11. McNealy will be giving the Wednesday morning keynote address at the San Jose Convention Center. It's not too late to make plans to attend. Contact peter@sug.org.

Meanwhile, take a look at this month's "Features" section. We have put much of our effort behind one topic: graphics. Michael Jay Tucker's wide-ranging special report shows how Sun's emphasis on standards and competent performance has found a sympathetic audience even in application areas long thought to be bastions of specialized software and hardware.

Doug Pryor

SUNEXPERT Magazine
An Independent Forum for Open Systems
NOVEMBER 1991 VOL. 2 NUM. 11

publisher
S. HENRY SACKS

editor-in-chief
DOUGLAS PRYOR

executive editor
MICHAEL JAY TUCKER

senior editor
MARY JO FOLEY

technical editors
BARRY SHEIN
RICHARD MORIN

contributing editor
MARK SEIDEN

research editor
MAUREEN MCKEON

production editor
MARY ANNE WEEKS

design director
STEVEN LEE

production director
RICHARD M. ABAID

associate designer
HANNA DYER

assistant production manager
DEBORAH BEDLOW

circulation manager
DEBORAH MOORE

circulation assistant
DIANNA DAPKINS

assistant to the publisher
LESLIE GAFFNEY

EDITORIAL ADVISORY BOARD

STEVEN KIRSCH
Frame Technology Corp.

STEVEN CHRISTENSEN
MathSolutions Inc.

ANIL GADRE
Sun Microsystems Inc.

ROBERT BROWN
RIACS/NASA

MICHAEL BALLARD
Telebit Corp.

DOUGLAS KINGSTON III
Morgan Stanley & Co.
Sun User Group Board

EDITORIAL OFFICES

1330 BEACON STREET
BROOKLINE, MA 02146
(617) 739-7002
Email: dpryor@expert.com



IMSL presents *exponent* GRAPHICS™

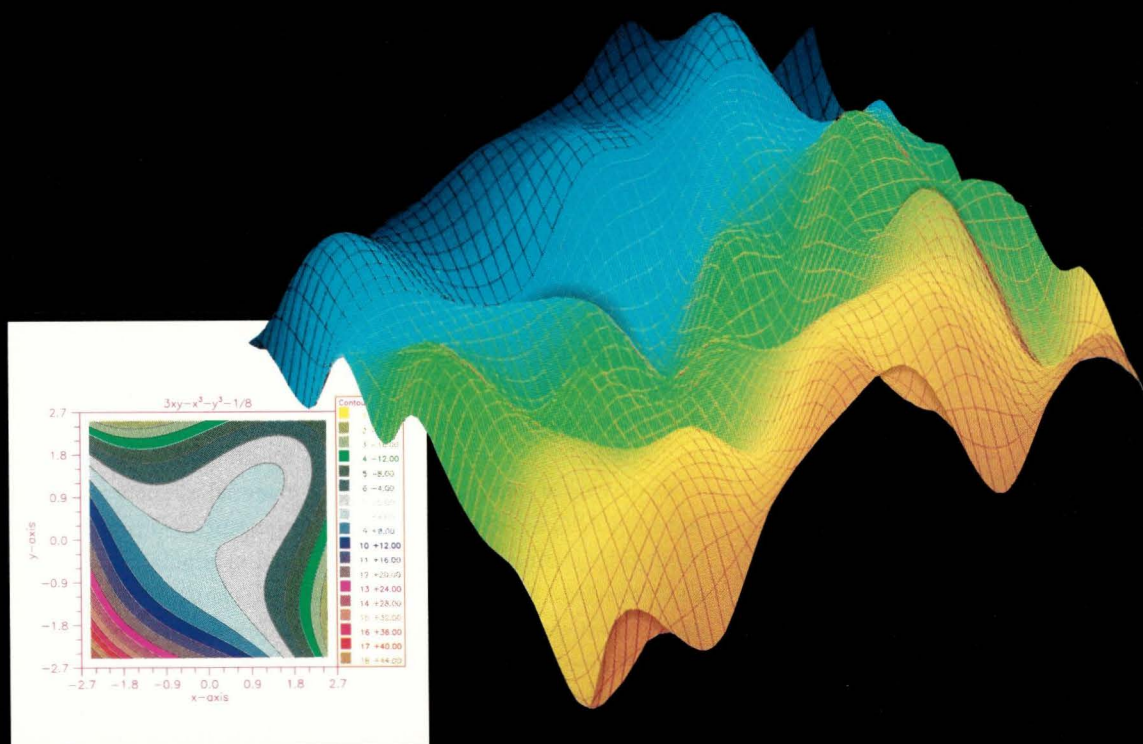

Raising FORTRAN graphics to a new power

Powerful graphics creation and FORTRAN programming are at your fingertips with the IMSL® Exponent Graphics system. Extensive customization capabilities and an easy-to-use FORTRAN format make Exponent Graphics subroutines the graphics resource of choice for your scientific and engineering computing.

■ Custom graphs, powerful capabilities

Automatically create graphs for scientific and engineering applications with just two calls to high-level subroutines. Or, rapidly create and customize your graphs through a hierarchical tree data structure that allows for inheritance of plot attributes. These capabilities reside in a complete, self-contained package.

■ A powerful FORTRAN resource for graphics

The capabilities you need are now available in a single, comprehensive FORTRAN resource that is both powerful and easy to use. Combining Exponent Graphics subroutines with your existing FORTRAN resources can further increase the system's flexibility, and enhance the capabilities of your overall computing platform. The Exponent Graphics system includes features that other FORTRAN packages lack, such as boxplots, polar plots, error bars, and true hidden surfaces.

To receive a full-color brochure describing Exponent Graphics software, call IMSL toll-free at 1-800-222-IMSL. In Texas and outside the U.S., call (713) 782-6060. Or contact IMSL at 2500 Permian Tower, 2500 CityWest Boulevard, Houston, Texas 77042-3020; facsimile (713) 782-6069.

"Exponent Graphics' contouring is more extensive than other graphics packages we have used."

Jack Lund, systems analyst,
University Computation Center

"You get immediate results...and the support from IMSL is excellent."

J.M. Vree, engineering analyst,
SKF Engineering and Research
Centre B.V., The Netherlands

"Exponent Graphics is really convenient...especially the speed, that's something we really like."

Mike Kimble, system administrator,
Center for Electrochemical
Engineering

"Much easier to use than other graphics packages; very powerful."

Stefan Boeriu, user consultant,
Center for Computational Science
and Engineering

Just for the Fun of It

Dear Editor:

Just want you to know most of the hackers I know greatly enjoy Mr. Protocol. In fact, he is 90% of the reason I read *SunExpert*. The other stuff is enjoyable, but Mr. Protocol is fun.

Oh yeah, that Michael O'Brien guy is OK, too.

Kevin Layer
Franz Inc.
uunet!Franz.COM!layer

POSIX Position

Dear Editor:

Peter Salus' standards column "Real Time, At Last" (*SunExpert*, July, Page 50), may have inadvertently left the readers with the impression that our VxWorks real-time operating system lies beyond the reach of emerging POSIX real-time standards.

To set the record straight, we actively participate in POSIX committee work and will produce and sell POSIX-compliant versions of VxWorks when this standard is finalized by the IEEE. Furthermore, our company has recently become the first real-time software firm to join the x/Open ISV council with the express purpose of achieving international recognition and x/Open branding for real-time POSIX.

As pioneers in the area of UNIX-compatible real-time software, we welcome the emergence of POSIX standards and look forward to maintaining our lead in delivering the most advanced open systems, real-time solutions.

Mitch Bishop
Director of Marketing
Wind River Systems Inc.
Alameda, CA 94501

Hidden Meaning

Dear Editor:

I would like to correct the reference made to our company in the excellent article "Operating Systems: Where To From Here," by Mary Jo Foley (*SunExpert*, June, Page 50).

Hidden in the text was "KFW (a PC add-in board vendor)." In fact, KFW Corp. designs PC add-in SPARC, coprocessor and parallel processor boards. All of our designs are manufactured and sold by licensees.

We developed the first ever PC add-in SPARC board in 1989 (distributed by Definicon) and are about to release our latest SPARC product, which provides a RISC workstation on a single-slot PC add-in card.

The point is minor, but important to us.

L. G. Pane, President
KFW Corp.
Thousand Oaks, CA

Mirror Images

Dear Editor:

I wouldn't want the person who is drawing out network connections on the cover (or page 51) of the August issue of *SunExpert* to work on one of our networks.

Look carefully; he is writing backwards. Are his networks backwards as well? :-)

Michael L. Brown
uunet!cs.wisc.edu!ftms!
brown%astroatc.UUCP

You Could Look It Up

Dear Editor:

Entertainment is one thing; accuracy is another (*SunExpert*, July, Page 29). The Oxford English Dictionary was definitely not "done using troff." In fact it was not "done" on a UNIX system.

I would not like anyone to imagine we litter the texts of our dictionaries with typesetting codes. On the contrary, we litter our texts with generic tags that are somewhat less ugly and rather more meaningful. This means that our material is independent of the equipment/software used to store and manipulate it.

To clarify for Mr. Protocol: We have a big investment in Sun/UNIX and we do make extensive use of `ditroff` internally. We can achieve printed text of more than acceptable quality for the day-to-day needs of our lexicographers given the work done on front and back ends for `ditroff` and the creation of fonts, etc. The following changes are achieved programmatically: `text -> troff -> PostScript`. But that is in-house. We leave typesetting to experts.

The OED project was done at the University Press on an IBM 4341 donated by IBM United Kingdom Ltd. The book was typeset by Filmtyp Services Ltd., Scarborough, United Kingdom, and manufactured in the United States by Rand McNally & Co., Taunton, MA.

James Howes
Head of Reference Computing
Oxford University Press
uunet!oup-uk!jhowes

NOW AVAILABLE: NATIONWIDE ON SITE SERVICE

Better Cards. Lower Ante.

Features	Artecon ¹	Brand A ²	Brand B ³
Modem control on All SBus serial boards	Yes	No	No
Based on the latest RISC-based processor	Yes (Cirrus CD-1400)	No (Motorola MC68HC000)	No (Cirrus CD-180)
CPU burden ⁴	20-25%	Not Tested	45%
SBus serial cards available	3 Serial / 1 Parallel 4 Serial / 1 Parallel 8 Serial / 1 Parallel 12 Serial / 1 Parallel 16 Serial	4 Serial 4 Serial / 1 Parallel 8 Serial	2 Serial / 1 Parallel 4 Serial 8 Serial 16 Serial
Software GUI for easy terminal/modem configuration ⁵	Yes	No	No
Software GUI for easy printer configuration ⁵	Yes	No	No
Warranty	1 Year	90 Day	1 Year
List Price	\$495.00 to \$1,295.00	\$999.00 to \$1,495.00	\$595.00 to \$1,995.00

subject to change without notice.
¹ CPU burden rates based upon benchmark tests. Artecon's white paper "SBus Asynchronous Serial Card Benchmark" available upon request.
² TTYTool software is bundled free with purchase of an Artecon SBus Card.

With the broadest range and the highest performance serial multiplexor cards available, Artecon's cards give you the winning hand.

Add up to 16 serial ports per slot with Artecon's SBus multiplexor cards. All of our serial cards have built in modem control and are based on the latest Cirrus chipset. That means the lowest CPU burden of any serial card on the market.

And to ensure you have a total serial device solution, every card comes bundled free with Artecon's device driver and *TTYTool*TM, our GUI software, the new easy-to-use serial device configuration utility. *TTYTool* makes setting your

printer, terminal, and modem configurations as easy as clicking on an icon.

Best of all, these expansion cards come from Artecon: the leading manufacturer of quality peripherals for your workstation.

Now you don't have to ante up any more money to get the best cards. Play your cards right. Call Artecon now.

1-800-USA-ARTE



2460 Impala Drive • Carlsbad, CA 92008-7236
(619) 931-5500 • FAX (619) 931-5527 • (800) 872-2783

A Member of the Nordic Group of Companies

Trademarks and registered trademarks are proprietary to their respective manufacturers

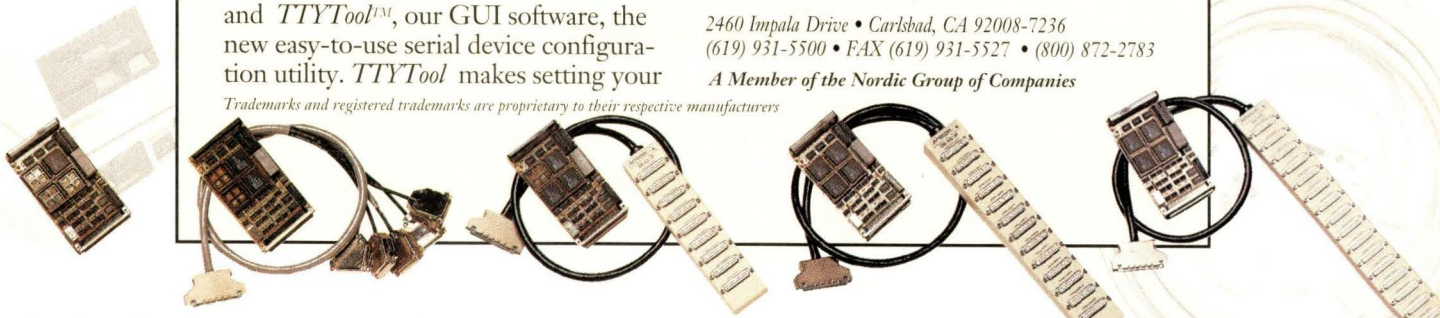

Part Number: SB-300P
Three Serial Modem Lines/
One Parallel Port - \$495.00

Part Number: SB-400P
Four Full Modem Serial Lines/One
Parallel Port - \$695.00

Part Number: SB-800P
Eight Full Modem Serial Lines/One
Parallel Port - \$895.00

Part Number: SB-1200P
Twelve Serial Lines (Four Full Modem)
One Parallel Port - \$1,095.00

Part Number: SB-1600
Sixteen Serial Lines
(Eight Modem) - \$1,295.00

SBUS CARDS

CANADA
1 800 872-2783

UNITED KINGDOM
44-3727-42557

FRANCE
33-1-6907-2822

JAPAN
81-3-3280-5030

GERMANY
89-3232320

AD06

Circle No. 4 on Inquiry Card

Of Epoch's Proportions

Dear Editor:

I am writing in regard to the article "There's More Than One Way to Network a Sun," (*SunExpert*, August, Page 50). The article was very well written and discussed some important topics. As you know, the Epoch System was mentioned in the portion of the article that refers to LSI Logic.

Unfortunately, I believe the Epoch

System was unfairly represented, although much of what was written was technically accurate. I would like to clarify a couple of points.

The Epoch is not a jukebox. It uses optical-disk jukeboxes, magnetic disks, RAM and Exabyte tapes in conjunction with hierarchical migration, backup and archiving software. These pieces are integrated into a complete storage-management solution.

The Epoch does provide a complete

backup solution. The Epoch-1 is the only system that backs itself up. As a matter of fact, it is the only system available that can back up large-scale systems (up to a terabyte) overnight. It can back up to Exabyte tape, 12-inch optical media and 5 1/4-inch optical media. What the Epoch is not designed to do is to be backed up by another system, such as is the case with LSI's Delta System.

It is true that the low-end Epoch-1 can only load two platters at a time. However, since active data always resides on the Epoch's magnetic disks while inactive data is migrated to optical jukeboxes, the number of drives is rarely an issue.

Andy Hettinger, Marketing Manager
Epoch Systems Inc.
8 Technology Drive
Westboro, MA 01581

Premiere Issue!

A PRACTICAL JOURNAL OF THE X WINDOW SYSTEM

THE X RESOURCE

Programming in the X environment can be difficult. You need access to subjects that are too specialized for magazines and developments that are too recent to have been incorporated into books. How do you take advantage of other programmers' experience? How do you keep current?

The X Resource is a quarterly, working journal for X programmers. Its goal is to provide practical, timely information about the programming, administration, and use of the X Window System:

- Over-the-shoulder advice from programmers who share their experience.
- Suggestions from the people who wrote your software tools.
- Insight on making better use of public domain tools for software development.
- In-depth tutorial and reference documentation.
- Annual Proceedings of the X Technical Conference held at MIT. (O'Reilly & Associates is the official publisher of the Proceedings.)

For those programmers who want to review proposed X Consortium standards, and participate in setting those standards, supplements to *The X Resource* will include:

- Public Review Specifications for proposed X Consortium standards.
- Introductory explanations of the issues involved.

You can order *The X Resource* and supplements for \$80 per year. Subscription to the journal alone is \$65 per year. (Foreign shipping extra.) Order before December 31 and receive the premiere Fall 1991 issue free with your 1992 subscription — 5 issues for the price of 4.

Call or write for more information.

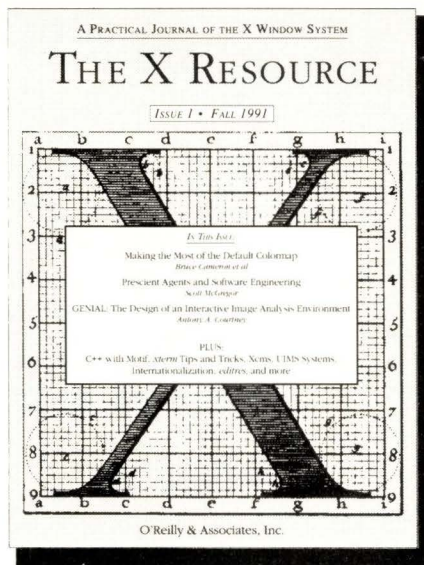

Object Lesson

Dear Richard Morin:

Thank you for an excellent introduction to object-oriented programming (*SunExpert*, August, Page 39). I'm new to the OO software world. Your article was a sight for sore eyes and a fogged mind! The list of resources was great!

I've just started here at Datacube as a technical writer with hardware and software tasks. Our software is definitely C, and object-oriented. We make pipe-line image processing products for OEMs. My new position requires a lot of background reading, usually done on my own time. Your article was, is, first rate!

Chuck Dasaro

uunet!datacube!charles

FYI

"Letters to the Editor" may be edited to conform to *SUNEXPERT* style-guide and space requirements. The views expressed are those of the author and not necessarily those of *SUNEXPERT*.

O'Reilly & Associates, Inc. • 632 Petaluma Avenue • Sebastopol CA 95472
(800) 338-6887 • (707) 829-0515

JTAX
BIXI

THOUSANDS OF UNIX USERS HAVE BEATEN DOWN OUR DOORS TO GET OUR PROGRAMMING ENVIRONMENTS FOR C AND C++.

SO WE MOVED AND CHANGED OUR NAME.

It's not like we did it on purpose or anything.

But when you grow by 200% a year, you tend to go through office space faster than a team of programmers can go through a take-out pizza.

Our name was a different story. We changed it from Saber to CenterLine for several reasons. But mostly because we wanted our name to underscore where we stand in the software development process: Right in the center.

Thankfully, little else has changed.

We still make the leading programming environments for those who program in C and C++ on UNIX[®] workstations. Once known as Saber-C and Saber-C++, they're now called *CodeCenter*[™] and *ObjectCenter*[™].

(With typical productivity gains of 25 to 200%, most users couldn't care less what we call them.)

And both *CodeCenter* and *ObjectCenter* still provide the same unbeatable features that empower you to create, test, debug and enhance your software applications— all within a single, easy-to-use programming environment.



Like an interactive workspace for rapid prototyping and unit testing. Automatic static and (the industry's only) run-time error detection that tells you what's wrong and where to find it. Dynamic graphical browsers for easy navigation through complex code. An incremental linker that reduces your turn-around time to seconds. And a world-class source-level debugger.

Plus we do all this without ever changing the way you work. Except to help make you a whole lot faster.

To find out why thousands have beaten down our doors, call for technical info on either *CodeCenter* for C or *ObjectCenter* for C++: 1-800-922-3229.

Or you could stop by. But please, take it easy on the doors.



CenterLine Software, Inc., 10 Fawcett Street, Cambridge, MA 02138 • (617) 498-3000

Circle No. 7 on Inquiry Card

NEWS

The New Universe, According to Sun



The 600MP Series represents Sun's long awaited foray into multiprocessing.

Galaxy Multiprocessors (Finally) Make Their Debut

Ending months of speculation and following several well-publicized delays, Sun Microsystems Computer Corp. has finally announced its long-awaited line of multiprocessor servers, plus associated system software. The new machines, collectively known as the SPARCserver 600MP series, are expected to sell into commercial MIS/DP computing settings as well as various electronics design applications—both markets where Sun has met significant competition from multiprocessor SPARC-system vendor Solbourne Computer Inc.

The specific 600MP models are the SPARCserver 630MP, 670MP and the 690MP. All the machines support a two-processor Mbus module and can be expanded up to four processors via a second module. The machines are shipping with 40-MHz Cypress Semiconductor Inc./Ross Technology SPARC modules, but will be able to be upgraded with plug-in 100-MHz SuperSPARC (Texas Instruments Inc.'s Viking) modules early next year. Their

operating system is SunOS 4.1.2, which is based on standard SunOS, recently re-christened as SunSoft's Solaris 1.0, but with multiprocessing extensions. Significantly, these multiprocessing extensions will not be made available to SPARClike vendors.

The most dramatic aspects of the 600MPs, however, may not be in their multiprocessing technology at all. Rather, it is in their network performance and their packaging. As network machines, the 600s are said to offer some 800 NFS I/O operations per second. This rivals specialized network accelerators.

In terms of packaging, the 600s are identical to older rack-mount Sun uniprocessors—specifically, the Sun 3/180, /280, /480 and 4/280. Owners of those machines can upgrade to a multiprocessor with a board swap. Not even the power supply needs to be upgraded.

Moreover, the MPs are VMEbus machines. In fact, they are essentially single-board VME systems that can plug in and out of the standard VME Sun chassis. However, they are also

SBus devices, having connectors that allow SBus cards to plug directly onto their surface. As a result, Sun server users can exploit the growing numbers of SBus cards.

In terms of specs, all three 600s offer 55 MIPS in dual-processor configuration, and 100 MIPS with four SPARCs. The 630MP has 64 to 128 MB of memory, 26 GB of SCSI disk, 5 VME slots and 4 SBus slots. The 670MP has 64 to 640 MB of memory, 26 GB of SCSI disk, 12 VME slots and 4 SBus slots. The 690MP has 64 to 640 MB of memory, 52 GB of IPI disk, 16 VMEbus slots and 4 SBus slots.

Pricing for the 600MPs depends on the number of processors. A dual-processor 630MP is \$45,000, or \$57,500 for four processors. The 670MP is \$60,000 as a dual processor, or \$27,500 in the four-processor model. The 690MP is \$92,000 or \$104,500.

Sun also is stressing the low cost of ownership with the MPs. Company officials say, for instance, that disk costs only \$4.08 per MB. Sun also says that the MP's CPU modules can be easily swapped for new ones, as more advanced SPARC processors become available.

In terms of market, meanwhile, Sun says that it hopes to sell MPs in competition with Solbourne boxes into the technical-design markets. The lack of a large, multiprocessor server has hurt Sun in places like aerospace and electronics, where designers need to drop simulations to centralized servers.

However, the target that Sun talks most about is commercial MIS and data processing. Sun stressed the fact that the machines offer between 120 to 150 transactions per second, which is important for OLTP applications.

Sun calls the box an "open departmental server," and says that it is meant to fit between desktop systems and corporate mainframes. In other

words, it is meant for precisely the same mission as the middle, minicomputer-based segment of the "three-tiered model of computing," which has been widely discussed within the MIS community over the last decade.

In a three-tiered model, mainframes provide a repository for corporate data and computer services, PCs and personal workstations provide desktop business tools and a middle class of servers acts to link the two and manage their relations.—*mjt*

Solaris Also Rises

Since it was unveiled at SunSoft's Catalyst Developers Conference, Solaris has won endorsements from hardware and software vendors alike. The biggest surprise about what SunSoft calls the "industry's first 'shrink-wrapped' distributed computing environment" is that it will be available on not only SPARC-, but also Intel Corp.-based platforms. The biggest yawn: End users won't have access to a UNIX-System-V.4-based operating environment until the middle of 1992. And application-accessible threads that enable the development of true synchronous multiprocessing applications will not be available until late 1992, with the Solaris 2.1 release.

Solaris 1.0, which is shipping now, consists of SunOS4.1.1, OpenWindows 2.0 and DeskSet 2.0. In shrink-wrapped form (a compact disk plus documentation), Solaris 1.0 retails for \$1,395 for full-fledged workstations and \$795 for "low-cost commercial systems, such as laptops," according to SunSoft.

Version 2.0 will incorporate SunOS 5.0 (based on SVR4 and including enhanced ONC), OpenWindows 3.0 and DeskSet 3.0. Developers also receive SunSoft's object-oriented environment, ToolTalk, with 2.0. Developer copies of 2.0 are available

now. End-user pricing for 2.0 will be announced next year.

Solaris' SunOS 5.0 will comply with major industry standards, including POSIX 1003.1, XPG3, ISO 9660, SVID 3 and SPARC International's SCD 2.0, says SunSoft. But as of press time, SunSoft had yet to announce its strategy to adhere to the Intel Binary Compatibility Standard (IBCS) 2.0, notes Scott McGregor, vice president and general manager for the distributed corporate computing business unit at the Santa Cruz Operation Inc.

With the announcement of Solaris, SunSoft has thrown down the gauntlet right in front of SCO with its Open Desktop environment. Open Desktop and Microsoft Corp.'s NT (New Technology) Windows are the operating systems that make up the Advanced Computing Environment (ACE) foundation.

Like their ACE rivals have done before them, SunSoft and the Solaris endorsees must find a way around byte-order differences (big endian vs.

little endian) between SPARC and 80X86 applications, McGregor points out. Currently, there are no Sun-based application packages that have been written to take advantage of the multitasking, multithreading capabilities promised in Solaris, he adds.

Comparatively, there are more than 2,000 Open Desktop-compliant applications, McGregor says.

SunSoft isn't just kicking back and waiting for Solaris to magically catch on. Sun has acquired the Systems Products Division of Santa Monica, CA-based Interactive Systems Corp. from Eastman Kodak Co. This division developed PC/IX and AIX for PCs and is a principal publisher of SVR4 for Intel 386/i486s. It is the entity that is doing the port of Solaris 2.0 from SPARC to Intel. The Naperville, IL-based Services and Technologies Division of Interactive, meanwhile, will continue to operate independently and act as the primary SunOS supplier for the SPARC clone market.

SunSoft Inc.'s Solaris: True symmetric multiprocessing is still a year away.

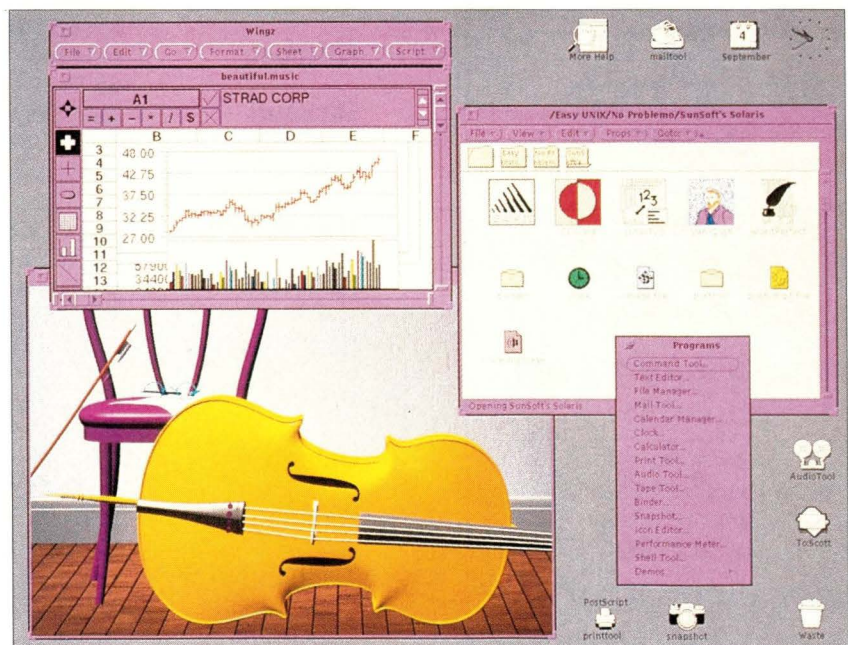

What is The Cdb Toolkit?

It's a Complete Multi-User RDBMS

Featuring:

- **UNIX Toolkit Design**
- **End User Tools**
- **No Programming Required**
- **Database Editors**
- **Report Generators**
- **Multiple Query Languages: dbSQL, dbAWK, dbMACRO**
- **Query By Example**
- **Open Look and SunView Accelerators**
- **Custom Screens**
- **Trigger and Macro Fields**
- **Menu and Update Tools**
- **Security Features**
- **Ready to Use Applications Including Bug Tracking, Expense, Inventory, Medical, Problem Reporting, Rolodex and Sales Monitoring**
- **Excellent Support**
- **Free Upgrades**
- **Optional C libraries**
- **Much, much more!**

**All for only
\$695**

**Now, aren't you
sorry that you didn't
ask earlier?**

**For more information,
B contact:**

**Jaybe Software
2509 N. Campbell, Suite 259
Tucson, AZ 85719
(602) 327-2299**

**1-800-JOB-4-CDB
(1-800-562-4232)**

NEWS

Already, numerous Catalyst vendors have committed to making their products Solaris-compliant. And manufacturers of SPARC and Intel platforms, including AST Research Inc., CompuAdd Corp., Dell Computer Corp., NetFRAME Systems Inc., Opus Systems, Star Technologies Inc., Tadpole Technology plc, Tatung Science & Technology Inc. and Toshiba Corp., have promised that they will make Solaris available on their systems.

ICL plc and Solbourne Computer Inc. also have come out in support of Solaris. Interestingly, neither of these vendors has yet committed to making Solaris available on its systems. Both already have their own symmetric multiprocessing operating

systems—ICL with its SVR4-based DRS/NX and Solbourne with its SunOS 4.1.1-based OS/MP. Rather, they are assuring users of future interoperability (and, in Solbourne's case, binary compatibility) between the systems.—mjf

X11R5 Hits the Servers

Release 5 of the X Window System, Version 11, is available worldwide. Users may ftp the code, or obtain 6250-bpi or QIC-24 tape directly from the Massachusetts Institute of Technology. Users need about 100 MB of disk space to hold all of the sources.

A partial list of North American ftp distribution sites is featured in the box below.

X11R5 Distribution Sites

Location	Address	Directory
California	gatekeeper.dec.com 16.1.0.2	pub/X11/R5
California	soda.berkeley.edu 128.32.131.179	pub/X11R5
Indiana	mordred.cs.purdue.edu 128.10.2.2	pub/X11/R5
Maryland	ftp.brl.mil 128.63.16.158 (good for MILNET sites)	pub/X11R5
Massachusetts	crl.dec.com 192.58.206.2	pub/X11/R5
Massachusetts	export.lcs.mit.edu 18.24.0.12 (crl.dec.com is better)	pub/R5
Michigan	merit.edu 35.1.1.42	pub/X11R5
Missouri	wuarchive.wustl.edu 128.252.135.4	packages/X11R5
Montana	ftp.cs.montana.edu 192.31.215.202	pub/X.V11R5
New Mexico	pprg.eece.unm.edu 129.24.24.10	pub/dist/X11R5
New York	azure.acsu.buffalo.edu 128.205.7.6	pub/X11R5
North Carolina	cs.duke.edu 128.109.140.1	dist/sources/X11R5
Ohio	ftp.cis.ohio-state.edu 128.146.8.52	pub/X.V11R5
Ontario	ftp.cs.utoronto.ca 128.100.1.105	pub/X11R5
Washington DC	x11r5-a.uu.net 192.48.96.12	X/R5
Washington DC	x11r5-b.uu.net 137.39.1.12	X/R5

Need Small Stuff Fast?

Just when you thought you had the Sun Microsystems Inc. empire down pat, Sun throws you a curve ball. But, in this case, users are unlikely to balk at Sun's delivery.

Now, in addition to SunSoft Inc., Sun Tech Enterprises Inc. and SunLabs, there are Sun Microsystems Computer Corp. (the hardware company) and SunExpress. Like the other aforementioned companies, SunExpress is a wholly owned subsidiary. Its mission is to improve Sun's infamously poor product-delivery times.

SunExpress comprises 60 telesales staff members, half of whom are located in the SunExpress headquarters in Methuen, MA, and the rest in California. (International expansion is planned for FY 1992.) The telesales force is instructed to take orders for more than 700 "low-ticket," non-system products. These include items such as SPARCprinters, disk and tape drives, memory-expansion boards, keyboards, cables, manuals, communications software and some software-development tools and utilities. Sun has acknowledged that products costing less than \$5,000 generated 66% of its fourth-quarter business during fiscal 1991.

To reach SunExpress, existing or new customers should dial (800) USA-4SUN. Currently, 91% of orders placed through the subsidiary are delivered within three days, according to SunExpress president Dorothy Terrell. All orders are guaranteed for delivery within five days, maximum. At press time, 90% of SunExpress' customers were resellers, OEMs and distributors, Terrell says.—mjf

GL To be Licensed

Silicon Graphics Inc. has announced that it will freely license its Iris Graphics Library to the computer industry. Among early licensees are Digital Equipment Corp., Compaq Computer Corp., Intel Corp. and Microsoft Corp.

Iris GL is a set of 440 software calls that reside between graphics applica-

tions and graphics hardware. SGI says that more than 1,400 applications are currently based on it—including products from some of the biggest names in graphics, such as Alias Research Inc., Thomson Digital Inc. and SoftImage Inc. Those applications were restricted to SGI's own hardware until IBM bought the right to use Iris GL on its own RS/6000 machines. However, recent IBM announcements have not emphasized GL.

The new licensing agreements are

being described as generous. There will be multiple levels of GL licensees—ranging from the right to be GL-conformant, to the right to use source code. While pricing was not available at press time, SGI executives have talked about starting costs of \$5 for lower levels of participation. A vendors and users consortium will oversee licensing.

Compaq, which has already invested \$137 million in SGI, says it will endorse GL and has said that GL will

What good is service that promises the moon when it means going for days without Sun.

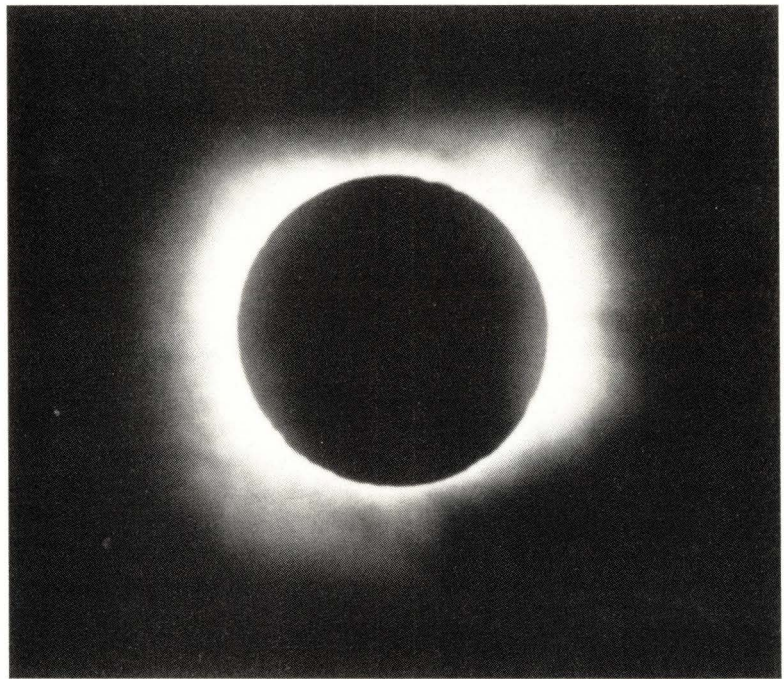

When you consider how much you rely on your Sun system, it's good to know you can always replace it. Fast.

Apex Computer's 24-hour emergency program guarantees next-day replacement.

It's part of Apex's full menu of support services, including remote maintenance, depot repair and technical phone support. And it's all backed by warranty.

We'll do everything we can to keep you from going without Sun. Even if it takes a little moonlighting.



APEX
COMPUTER

We also buy & sell used Sun equipment.

Seattle • Sunnyvale • Boston • 1-800-654-8222

IEEE 488. Data acq. For Sun. Now.

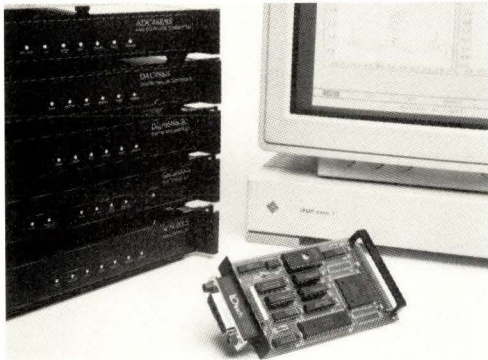

Only IOtech has all you need to turn your Sun workstation into a powerful laboratory system.

Control up to 14 IEEE 488 devices with IOtech's SCSI interface for the SPARCstation, Sun-3, and Sun-4 or our SBus interface for the SPARCstation. Each controller comes with an IEEE device driver that supports SunOS 4.1 and any high-level language.

Add an IOtech analog, digital, or serial I/O converter and graphical user interface software for complete data acquisition, control, and analysis.

Call, fax, or write today for your free IEEE 488 technical guide.

IBM PC, AT, 386, and PS/2 IEEE Products

Macintosh IEEE Products

Sun and DEC Workstation IEEE Products

Serial/IEEE Converters and Controllers

Analog and Digital I/O Converters to IEEE

IEEE Analyzers, Converters, and Extenders

IOtech, Inc. • 25971 Cannon Road
Cleveland, Ohio 44146
PHONE 216-439-4091 • FAX 216-439-4093

The products mentioned above are trademarks or registered trademarks of Sun Microsystems, Inc.

Circle No. 24 on Inquiry Card

NEWS

be the standard for 3D graphics programming for the Advanced Computer Environment (ACE) UNIX operating system. DEC says it will work with SGI in developing a GUI that will include IRIS GL, X, PEX (the PHIGS extension to X) and Display Postscript. Intel Corp. says it is interested in GL because of the i860 processor, which is being widely used as a graphics accelerator. Microsoft has "issued a statement" in support of GL, saying that it will facilitate developers working with NT Windows.

As of press time, Sun Microsystems Inc. had not voiced support or otherwise for GL. Sun has recently introduced XGL, which it says brings GL-like programming to Sun X-based displays.

Meanwhile, GL emulations exist, and the effect that GL's release will have on their vendors remains to be seen. Du Pont Pixel Systems, for example, has a GL-compatible environment for the i860. After the SGI announcement, Du Pont put out a release saying that it, too, supported GL as a standard and saw it as a means of extending its own GL-compatible business.—*mjt*

HiTech Laptop: Neither Fish Nor Fowl

It's not a repackaged RDI Inc. Britelite. Nor is it a clone of the TriGem Corp. SLT-100. It's the newest SPARC laptop and it's being manufactured by PC-cloner extraordinaire HiTech International.

The SAM3001 looks and acts an awful lot like the Britelite and TriGem boxes. The system, which weighs in at 13.5 pounds, is based on the LSI Logic Corp./Opus Systems 20-MHz SparKIT. Base configuration includes 8 MB of memory, 120 MB of hard disk, a 10-Mb/s Ethernet interface, a SCSI-2 interface, two serial ports and a 640-by-480-pixel backlit LCD screen. In fact, HiTech is buying a lot of its components from the same sources that TriGem uses in Korea. The company is doing its own final assembly in San Jose, CA. Neither Samsung Electronics Co. Ltd. nor Hitachi Ltd., HiTech's partners in the

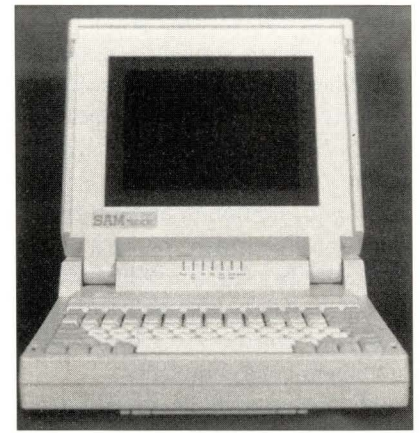

HiTech International's SAM3001: It looks like the Britelite, but it's not. ...

PC arena, are working with it on its SPARC project, says company president Ken Kim.

The HiTech, which is scheduled to ship before the end of the year, also will be able to emulate the Apple Computer Inc. Macintosh and IBM Corp. PC, according to Kim. Kim says that HiTech is working directly with the creator of the Mac-emulation technology for SPARC, Xcelerated Systems Inc., as well as with Insignia Solutions Inc. and Borland International Inc.'s Ashton-Tate division, to provide software for the system. Kim says HiTech is looking at bundling dBASE with the SAM3001.

HiTech has priced the machine at \$8,995 (street price) and \$6,500 (reseller price). The company is seeking VARs and dealers that might be interested in carrying the product.—*mjf*

The X-Terminal Make-Over Contest

Models do it. Race cars do it. Even desktop devices do it. Sooner or later, they get a make-over.

But X-terminal manufacturers want to make later sooner. After all, there are 12 million aging ASCII/ANSI units out there, ripe for a relaunch into the brave new world of open computing. Furthermore, X-terminal makers believe they can go head-to-head against diskless workstations with faster speeds, video displays and the capability to run a mix of existing user programs at less cost.



Clean.

This is the scenario: You spend your hard-earned money on a computer from a second source supplier. It arrives dusty, stained and smudged. Nobody wants to get near the thing.

You can be sure that it didn't come from us, because Rave computers are Stronger Than Dirt! In fact, we guarantee it. (More on that later.)

Rave understands the importance of a good first impression. A sparkling-clean computer says something about our attitude towards our inventory — and, ultimately, our clients.

So when we refurbish hardware, we roll up our sleeves and do it right. Our components get a thorough cleaning, inside and out. We do it the old-fashioned way: By hand, using lots of elbow grease.

We want you to enjoy your purchase so much that we offer the exclusive *Raving Beauty Guarantee*. If you're not satisfied with the appearance of your hardware, we'll take it back.

No other second source supplier makes that statement.

Of course, we still warranty our equipment for 60 days, and give you the most competitive price in the industry. Call us. We love to talk while doing the laundry.

Rave Computer Association, Inc.
 36960 Metro Court, Sterling Heights, MI 48312
 (313) 939-8230 Fax: (313) 939-7431



**Sun Microsystems -
 Buy, Sell, Trade.
 Data General Also Available!**

Stone.



**NCD 17c X terminal.
29,000 X stones.**

The HP 700/RX family of X stations continues to open up a huge lead in the X stone race.

The first family based on RISC, it's also the first to offer entry-level workstation X performance at X terminal prices. So you can run demanding X applications you'd never have considered before.

Now that you can enjoy the performance benefits of RISC at no extra cost, what are you waiting for? Because every day without RISC, you're falling further behind.

Our accelerated color models perform almost three times faster than NCD. And our monochrome X station comes in at

an astounding 90,000 X stones. All HP 700/RX models use flicker-free monitors, with high refresh rates. You have a choice of 19" color or monochrome with 1280 x 1024 high resolution, and 16" color with 1024 x 768. In all models, we're continually adding features and enhancing functionality.

Milestone.



HP RISC X station.
~~75,000~~ X stones.
86,000

Do you wonder HP was recognized by Dataquest,¹ International Data Corporation² and Xerox Business Group³ as the industry's leading supplier of color terminals in 1990.

So call 1-800-752-0900, ext. 2636* and meet the latest family of RISC X



terminals. With these milestones, your company could go a lot further.



Circle No. 19 on Inquiry Card

Storage, Back-Up, Printers, Scanners and more.

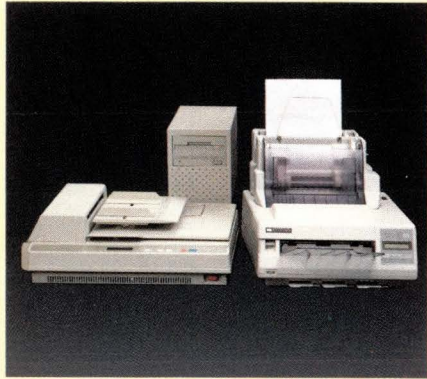

From disk drives to optical disks to laser printers and scanners, Cranel offers a range of peripherals from the quality leaders. Like Fujitsu, Hewlett-Packard, Kofax, Cornerstone, Cipher and more. Toll-free technical support and expert sales assistance ensures you get the application support you need. Peripherals for Sun, Apollo, DEC, Data General, NCR, AS/4000, RISC/6000 and more.

Cranel Products:

- 8", 5 1/4" and 3 1/2" Disk Drives •
- Rewritable Optical Disk and Jukebox • Monitors •
- 3480-Compatible Tape •
- 1/2" Tape • 1/4" Tape •
- 4 mm DAT • 8 mm Cassette •
- Laser Printers • Scanners
- Systems •

Call Toll-Free: 800-288-3475

GSA Contract #
GS00K90AGS5248

CRANEL
INCORPORATED

"The Peripheral People"

FUJITSU  **HEWLETT
PACKARD**

Circle No. 11 on Inquiry Card

Major vendors such as Digital Equipment Corp., Hewlett-Packard Co. and IBM Corp. are expected to offer X-terminals to their installed base as a matter of course. But Eileen O'Brien, a market analyst with International Data Corp., Framingham, MA, observes that while the Big Three may offer their users the advantage of "one-stop shopping," the X-terminals from IBM and DEC will be over-priced and under-featured.

Into this seemingly captive market, therefore, can step the likes of smaller, independent vendors such as Network Computing Devices Inc. and Tektronix Inc. to offer better and cheaper X-terminals. And they have committed sizeable budgets to marketing their advantages, she adds.

Leading the charge of "MIS here we come," the Network Displays Division of Tektronix, located in Wilsonville, OR, has become the latest manufacturer to unveil X-terminals aimed at commercial data-processing users. To date, the company has 7,000 color-monitor X-terminals installed in the technical community worldwide.

The four-member XP10 Series includes a 15-inch monochrome unit for \$1,695, a 15-inch grayscale at \$1,995, a 14-inch with 16 pixels at \$2,495 and a 14-inch with 256 pixels at \$2,895. As part of its marketing effort, Tektronix is also targeting networked installations and has established a Network Services program, offering consulting to help integrate X-terminals into a LAN environment.

By 1994, according to IDC's O'Brien, the combined forces of the Pacific Rim and RISC will bring the cost of X-terminals down to \$500. Stephen King, network displays division marketing director for Tektronix, estimates that in one to two years, the X-terminal "window" will become a "push market." With the prolonged recession, there could be an even more immediate price decrease in an attempt by vendors to shore up sagging revenues. —hcp.

Other Open Systems News

Digital Equipment Corp.

DEC unveiled its target dates for supporting the Open Software Foundation's Distributed Computing Environment (DCE). A starter kit for software developers will be available on OSF/1 in early 1992, DEC says. End users will be able to make use of "full" DCE capabilities on OSF/1 by mid-1992. Over the next 18 months, DEC will deliver DCE on its various Network Application Support (NAS) platforms, including VMS, PC and multivendor system platforms, according to the company. Customers currently implementing DEC's Enterprise Management Architecture (EMA) solutions, including DECmcc Director, will be able to add OSF's Distributed Management Environment (DME) capabilities as they become available, DEC adds.

DEC and Mountain View, CA-based Silicon Graphics Inc. announced a joint agreement to develop a common, integrated graphics environment. The environment will be based on SGI's IRIS GL programming libraries, as well as PHIGS/PEX, X and Display PostScript. DEC and SGI will jointly develop a reference implementation for a graphics server.

DEC has announced it will be offering a single-user license of Lotus Development Corp.'s 1-2-3 bundled with each DECsystem and DECstation platform sold through March 1992. The spreadsheet is called Lotus 1-2-3 for DEC's Ultrix for RISC Systems.

Hewlett-Packard Co.

You'll be able to buy your Series 700 workstations from various MicroAge Inc. and Intelligent Electronics Inc. franchisees beginning in January 1992, thanks to HP's new Certified Workstation Reseller (CWR) program. HP will be adding 100 dealers to its indirect-channel ranks. HP has been

selling its PCs, scanners and printers through the dealer channel for about 10 years. HP is talking about increasing its CWR pool to 300 (franchisees plus independents) by the mid-1990s.

HP announced Release 5.1 of RTAP/Plus, its industrial-automation enabler. RTAP/Plus 5.1 features HP-UX 8.0 compatibility; a Motif 1.1-based GUI; a display server that interconnects schematics, control panels and the RTAP database without programming; and HP Apollo 9000 Series 700 and HP 700/RX X station compatibility. In other real-time news, HP has selected Wind River Systems Inc., Alameda, CA, to provide real-time capabilities for its HP 700/RX X stations. VxWorks now runs on the station's Intel Corp. i960 processor.

HP has unveiled disaster-recovery services for its UNIX systems. HP has opened a disaster-recovery facility in Valley Forge, PA. Included in the offerings are risk analysis, training, rehearsals, temporary backup-computing facilities and restoration of computer operations.

IBM Corp.

IBM rolled out more than 100 new hardware and software products designed to "integrate the enterprise." The majority involved its S/390 and ES/9000 architecture. But a number of the announcements also revolve around IBM's client/server plans. IBM revealed database enhancements enabling OS/2, DOS and Windows users to better access mainframe data; new LAN products; distributed file-management and data distribution for NetWare servers from an MVS mainframe; and promises of future DCE compliance. In the network- and systems-management areas, IBM unveiled its Workstation Data Save Facility, which can back-up, restore, archive and retrieve workstation data (from Sun Microsystems Inc. and Apple Computer Inc. Macintosh platforms, among others) to a VM host.

The first packaged, disk-mirroring product for the RS/6000 family is available from Cambex Corp. The

Certainty 6200-MD Series is designed as a RAID Level 1 disk-mirroring subsystem. For \$7,950, users receive two 3 1/2-inch SCSI disk drives packaged in a single enclosure, along with a SCSI cable, Certi-STOR disk-mirroring software and an installation and operation manual. Cambex is based in Waltham, MA.

This Just In...

- **Saber Software Inc.**, Cambridge, MA, has, in one fell swoop, changed its name and enhanced its C++ product. Saber is now called CenterLine Software Inc. Its Saber-C product is known as CodeCenter. And its C++ product is called ObjectCenter. The newest release of ObjectCenter is 1.1. In 1.1, CenterLine has integrated pre-processor support for Versant Object Technology's OODB. ObjectCenter 1.1 also now supports Cfront 2.1, the standard version of C++ from USL. The product supports dynamic shared libraries in the Sun environment, too. The price remains \$395 for a single license.

- **SPARC International**, in conjunction with Carrollton, TX-based VMELaboratories, has announced it will begin offering testing and branding of SBus products. At present, the Menlo Park, CA, trade association is testing first-company-ship boards on 21 different SPARC systems that are SCD 1.0-compliant and six systems that are 2.0-compliant in order to determine if the products live up to their vendors' performance claims. Next, SPARC International plans to add a timing verifier to its peripheral test suite. Finally, along with VMELabs, SI will develop real hardware, device-driver and kernel-interface specs against which SBus boards will be tested and branded compliant. The cost of testing: \$1,500 per board, with \$995 for subsequent retestings.

- Beating Sun Microsystems Inc. to the punch, **Network Peripherals** has announced an FDDI SBus card. The FDDI adapter implements burst-mode DMA and comes with drivers for SunOS 4.1.1. The product provides a fully compliant Single Attach Station for use with FDDI hubs.

Service, Maintenance, Repair, Rental and more.

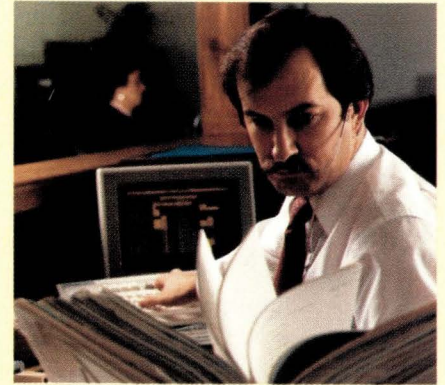

The Cranel difference begins with your first call and continues throughout the life of your equipment. You choose the service programs that meet your needs. Swap and repair keeps you on-line in event of failure. Maintenance contracts fix repair costs and even cash flow. Rental equipment is perfect for short-term conversion projects and evaluations. All repair work is factory authorized.

Cranel Services:

- Off-the-Shelf and Custom Subsystems •
- Installation and Service Support •
- Maintenance Contracts •
- Factory-Authorized Depot Level Repair •
- Swap and Repair Programs •
- Equipment Rental •
- Media and consummables •

Call Toll-Free: 800-288-3475

GSA Contract #
GS00K90AGS5248

CRANEL
INCORPORATED

"The Peripheral People"

FUJITSU  **HEWLETT
PACKARD**

• Going down memory lane: **Sun Microsystems Inc.** has unveiled its 4- to 16-MB memory upgrade path. Sun says that SPARCstation IPX customers now can replace one or more of their four 4-MB SIMM boards with 16-MB boards. Sun says that 16- and 4-MB SIMMS can be used together in combination, but only so long as it's all Sun memory. According to Sun, any combination of Sun and non-Sun 16- and 4-MB boards is likely to cause parity errors. One 16-MB SIMM upgrade lists for \$2,495.

• Other memory news: **Camintonn Corp.**, a memory provider in the Digital Equipment Corp. marketplace and **Parity Systems**, a Sun and Silicon Graphics Inc. memory vendor, have announced a strategic alliance. The agreement covers joint marketing, sales and engineering of minicomputer and workstation memory products. Camintonn is based in Irvine, CA; Parity is headquartered in Campbell, CA.

• As part of its show of force designed to counter the Open Software

Foundation DCE/DME announcement this fall, **UNIX International** has announced more of the technologies that have been selected to fill out its UI-Atlas framework. Predictably, **SunSoft Inc.** was a big winner. At the core of Atlas is ONC, SunSoft's Open Network Computing platform, comprised of enhanced NFS, the NIS+ naming service and the distributed object-management facility (OMF), developed jointly by SunSoft and Hewlett-Packard Co. Notably, ONC wasn't the only RPC selected. UI is promising that it will support multiple RPC protocols, at least one of which will insure compatibility with the OSF's DCE environment.

• DBMS tidbits: Burlington, MA's **Cognos** has completed the port of its PowerHouse fourth-generation language and StarBase relational database to Sun's line of workstations and servers. PowerHouse and StarBase together are priced from \$6,000 to \$222,500, depending on the number of users. **Progress Software Corp.**, Bedford, MA, has released Progress

Results, an interface and query tool for end users and developers. The tool is said to enable users with no programming experience to query, report and work with information stored in various databases, including Progress, Oracle, Rdb and RMS. The product is available in two versions—developer and end user/systems administrator—and sells for \$400 to \$134,000, depending on machine class.

• **Sun Microsystems Inc.** has selected disaster-recovery and maintenance provider NPA West, Fairfield, CA, to install, maintain and service Sun equipment at state and local government sites in California. NPA has provided similar services in the Data General Corp. marketplace. ➔

Did You Miss An Issue?

Back issues of *SUNEXPERT* can be purchased for the low price of \$1.50 per issue (subject to availability) plus shipping. To order, please call our Circulation Department at (617) 739-7001.

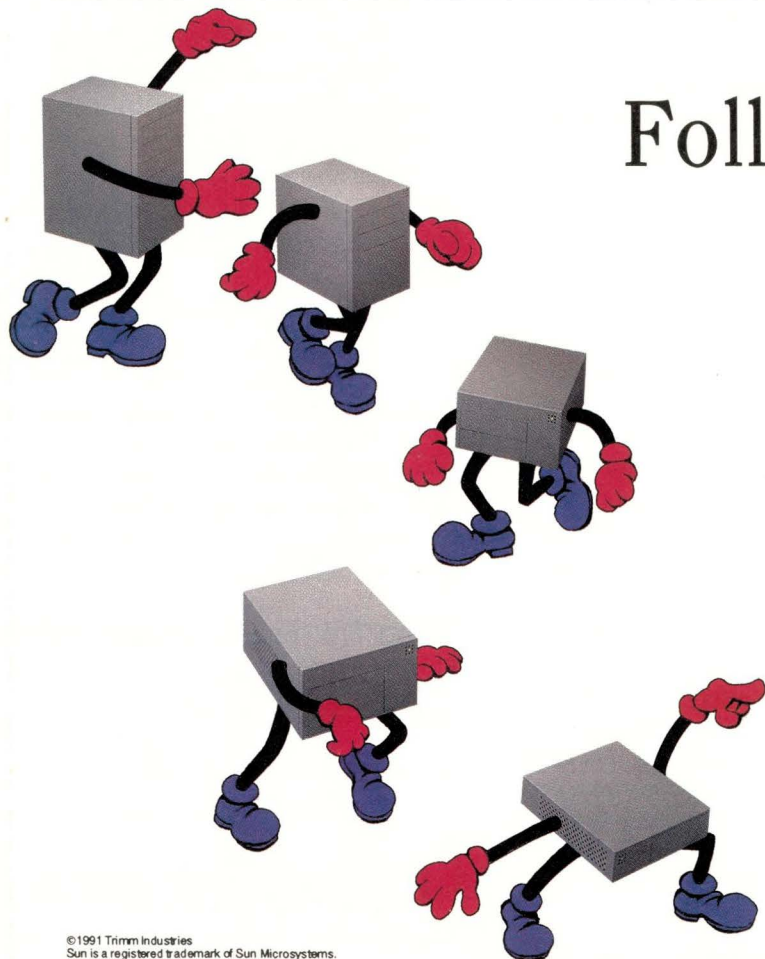

Follow the leader.

Around the world, Trimm leads the industry in desktop enclosures. Now the high quality, built-in reliability, and top performance that so many have come to count on, can be yours.

If you are looking for a peripheral expansion enclosure for a Sun™ workstation environment, the SP Series from Trimm Industries provides compatible configurations that will work for you. Mounting for combinations of 3.50" and both full and half-height 5.25" peripherals is available.

How do we do it? With innovative expansion packaging. With rapid service through our extensive distribution network. And with outstanding technical support.

Follow the kind of security and innovation that only the industry leader can give, contact our sales department today for more information on Trimm Industries' wide variety of quality products.

TRIMM INDUSTRIES

11949 Sherman Road, North Hollywood, CA 91605
 (800) 423-2024 USA, (800) 272-3557 CA, (818) 983-1833
 In Europe:
 2-6 Giltway, Giltbrook, Nottingham, NG16 2GN England
 Phone: (0602) 385485. Fax: (0602) 389973. Tlx: 378317.

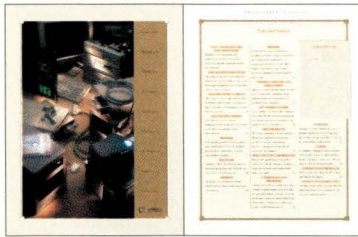

The Andataco Product Catalog is a window...

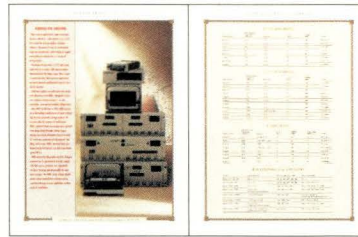

...onto a world of removable disk subsystems...

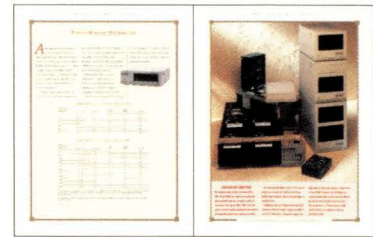

...internal and external disk subsystems...



...8mm, 1/4\"/>

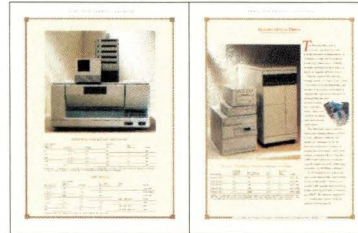

...erasable optical systems...



...custom cabinetry for disk and tape subsystems...



...software for Sun-PC and Sun-Mac connectivity...



...standard and specialty SIMMs for all platforms...



...terminal servers and serial port expansion...



...Sun workstations for specific applications...



...communication controller boards...



...disk and tape controllers...

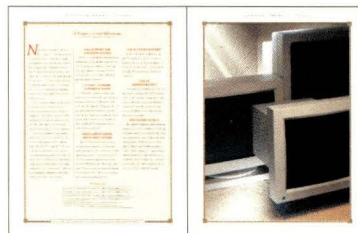

...X terminals and monitors...



...ethernet transceivers, converters and extenders...



...dial-up high speed modems...and more!

Call Us When You Want The Big Picture.

Andataco can enhance and expand your power-computing horizons through an extraordinarily broad range of products. All backed with the premier UNIX Technical Distributor's assurance. Of high-performance. Advantage-pricing. Prompt delivery. And expert support. Call today for your

free copy of the Andataco Catalog. Then let a Sales Engineer help you configure the system you need. Only when you've seen the big picture will you know why so many people turn to Andataco for workstation solutions. 1-800-334-9191.



San Diego* 619-453-9191 Fax 619-453-9294	Los Angeles 213-585-9191 Fax 213-374-3432	San Fernando/Ventura 805-523-9191 Fax 805-523-9294	Orange County 714-364-9191 Fax 714-364-9294	Northern California 510-659-9191 Fax 510-226-9294	Seattle 206-377-8181 Fax 206-377-4701	Washington, D.C. 301-963-9191 Fax 301-417-9294 GS00K-91-AGS-S896
--	---	--	---	---	---	---

*Corporate Headquarters: 9550 Waples Street, San Diego, CA 91921, E-mail: INQUIRE %ANDATACO.UUCP@UCSD.EDU All product names are trademarks of their respective companies.



ILLUSTRATION BY TOM BARRETT

by MICHAEL O'BRIEN

The Other X: International Cooperation and Its Horrors

“Q: What do you get when you cross a gangster with an international standard?”

A: You get someone who makes you an offer you can't understand!”

—The Cynic of the Internet, as reported by Marshall Rose

“Standard (n)—1. A document describing how everyone ought to do something. 2. A flag waved before troops going into battle.”

—The Bit-brain's Dictionary

Q: Mr. Protocol always seems to be smiling. Is he really such an optimistic, happy fellow?

A: All things are relative, even Mr. P. (But thank heavens he's no relative of mine.) Mr. Protocol is smiling all the time because he lives in a world where network protocols work all the time, and where technology is the main driving force behind new developments. In other words, he lives a.) in the past, and/or b.) in fantasy land. He regards this as one of the chief benefits of his particular brand of irrationality. You see, he has seen how the other half lives. He has seen OSI, and lived.

Right off the bat, Mr. Protocol would

like to acknowledge a very valuable source of information, *The Open Book*, by Marshall Rose. In addition to being an excellent technical introduction to the world of OSI protocols, Mr. Rose also develops a personal perspective on the workings of the OSI standards community that's almost enough to wipe the smile right off Mr. P's mug. Mr. P. gratefully acknowledges Mr. Rose's contribution to what follows. Mr. Protocol is generally incomprehensible even when rational topics are being discussed. Listening to Mr. Protocol discuss OSI is not an experience to be entered into lightly, and Mr. Rose's assistance in lending clarity to the subject has been invaluable.

What is it, then, this thing called



Mitsubishi Color Thermal Printers Make Your Sun Shine Brighter.

High Quality Color Hardcopy From Mitsubishi

With Mitsubishi® color printers, your Sun SPARCstation™ has never looked better.

Bright and bold, advanced resolution graphic output is ideal for a variety of color imaging applications. Choose from a range of performance characteristics within Mitsubishi's full line of color printer models, each designed for maximum reliability and value.

With the introduction of NeWSprint™ software, Mitsubishi's printers can be attached to a single Sun SPARCstation to produce PostScript™ compatible output or from any computer on the network via a SPARCserver™. The result: color printing is now fast, easy and more cost-effective because it eliminates the need for an expensive, dedicated hardware rasterizer laden with memory. Instead, it utilizes the SPARC's superior CPU for processing.

Mitsubishi's quality begins with the G370-10 and G650-10 color thermal transfer printers. These high-resolution printers deliver 300 DPI output on cut sheet paper or transparency film in sizes from letter

to tabloid (G650-10 only). The S340-10 thermal transfer sublimation printer offers near photographic quality with dazzling colors and prints on letter and legal size cut sheet paper.

All Mitsubishi printers are compact, reliable and easy to use for color-critical workstation applications including electronic pre-press, desktop publishing, presentation graphics, CAD/CAM/CAE, multimedia, medical imaging and geoscience.

Call or write Mitsubishi today and we'll show you how our high quality color printers can make your Sun shine brighter. For referral to the nearest authorized Mitsubishi Electronics sales representative, call 1-800-843-2515.



Mitsubishi Electronics America, Inc., Information Systems Division, 5757 Plaza Drive, Cypress, CA 90630
Mitsubishi Electric Sales Canada, Inc., 8885 Woodbine Avenue, Markham, Ontario L3R 5G1

© 1991 Mitsubishi Electronics America, Inc. Mitsubishi is a registered trademark of Mitsubishi Electric Corp., Tokyo. Sun Microsystems and the Sun logo are registered trademarks and NeWSprint is a trademark of Sun Microsystems, Inc. SPARC is a registered trademark and SPARCstation and SPARCserver are trademarks of SPARC International, Inc. PostScript is a trademark of Adobe Systems, Inc. Actual unretouched printed images produced from the following companies (trademarked software package name follows company name): Computer Support Corp. (Arts & Letters); Zenographics (Mirage); Centera Technologies, Inc. (GRAFkit); Sun Microsystems (NeWSprint). Operational note: Printers must run with Sun SPARCstation or SPARCserver with OS version 4.1; S-Bus Centronics® parallel adapter card and NeWSprint software required and is available from Sun Microsystems; device driver available from Mitsubishi Electronics.

Circle No. 28 on Inquiry Card

OSI, which seems to start everything off with the letter "X?"

Mr. Protocol is glad you asked.

Briefly, OSI is many things. To some, it represents the future. To others, it represents "the competition." Still others regard it, more simply, as disaster on the hoof. If Britain and America are two nations divided by a common language, they say, the OSI protocol suite represents a brilliant extension of this principle to include the rest of the world.

OSI stands for Open Systems Interconnection. This doesn't mean that the systems themselves need to be open, merely that the method used to connect them is open, as opposed to proprietary. And it certainly is open. Everybody gets a vote, in fact. And that, as we shall see, is the main problem.

The OSI protocol suite is the joint work of the International Standards Organization (ISO) and the CCITT, which is the acronym for a French title that translates as the International Telephone and Telegraph Consultative Committee. The CCITT is the international regulatory body whose member organizations are the Post, Telephone and Telegraph administrations of the countries of the world. Those few countries (like the United States) where the telephones and the post office are not run by a single government body are represented by a government agency of that country's choice. Although the protocols in the OSI suite are often referred to as ISO protocols, the names with which most of us are most familiar, such as X.25, are actually CCITT terms.

The OSI protocol suite and the TCP/IP protocol suite are of about the same age. Their genesis differs, though, and the difference is most enlightening.

The TCP/IP protocol suite was created because the existing national research net, the Arpanet, was having growing pains. Various (Dare we say it? Yes...) cockamamie schemes were being promoted to allow at least some machines that were not directly connected to the Arpanet to communicate with other machines. The pressures to

do this increased as local networks were assembled by the Arpanet's member organizations. Local nets were fairly new at this time, and the protocols and hardware implementations of those networks were often a matter of local invention. The result was the creation of a real Internet Protocol, and a suite of transport and application protocols on top of it, by a group that had had real experience in the area, and a firm grasp of the problems involved—as well as a clear field in which to put forth their ideas.

There were two factions at work in designing the lower levels of the OSI protocols.

The OSI protocol suite, on the other hand, was created by a string of large international committees, and it shows. It is not as simple as claiming relative levels of technical competence; it is a matter of orientation. The TCP/IP architects were focused on matters of data interchange using computers, while the OSI-protocol-suite architects were focused on the task of data interchange, period. They represented telephone and telegraph enterprises, and that orientation colors the result. There is a heavy odor of Telex and teletype about the lower levels, at least, of the OSI protocols.

The further problems were political in nature. There were two factions at work in designing the lower levels of the OSI protocols, which are devoted to "end-to-end" data transport. One group of people believed that data should be transferred via a virtual cir-

cuit. In the virtual circuit model, a route is negotiated through the network at the beginning of the transfer and resources are committed to the connection. All packets follow the route established at the time the connection is first made. There are several advantages here:

- 1.) The resources remain committed, so that network transit times are insensitive to network loading.
- 2.) Per-packet routing is a no-brainer: the route is figured out once, at the beginning of the connection.
- 3.) Routing, therefore, follows the well-established and well-understood principles already at work in telephone systems.

There are disadvantages too, though, such as loss of the ability to build survivable connections. If one of the intermediate nodes involved in the connection goes down, the connection is aborted, even though multiple routes may exist between the source and destination. Also, because of the necessity of committing resources at the time of connection establishment, the overhead of making a connection becomes quite high, and can take some time.

The alternative is the connectionless data-transfer model, where each packet finds its own way from source to destination. If this sounds familiar, it should: This is the way IP works. The downside of this arrangement, of course, is that per-packet routing overhead is much higher, and packets can arrive out of order.

The OSI protocol designers were never able to resolve this question. They included both specifications in the design of the lower-level OSI protocols. The result is an extra set of specifications that allows these differently flavored transport layers to communicate. The problem is that the real-world circumstances under which this interworking can actually take place is quite limited. For the most part, the OSI protocols have two incompatible end-to-end data transfer specifications, for purely political reasons. So it goes with international

standards operations.

Certainly one of the problems with the creation of such international standards is the necessity for consensus and political compromise which is found in any sort of international negotiation. The TCP/IP designers came from a single country and similar backgrounds—far from the case in the OSI world. However, it is also the case that the OSI designers had, and have, a tendency to standardize in advance of experience, which is always a dangerous undertaking. The Internet community does not declare anything to be a standard until it has been implemented and used...at least, so it has always been. This attitude is beginning to erode as Internet technology finds wider and wider acceptance in the commercial world, and larger and larger amounts of money are spent on TCP/IP networking (and networking products!). Internet technical decisions are becoming infected with politics, but there is a long way to go before matters become as grave as in the OSI world.

The Internet domain has always remained unified. There is a single low-level protocol, which is IP, and IP has a single addressing scheme. In the OSI world, addressing is specified by CCITT "Recommendation" X.121, which specifies several ways of expressing an address. The connection-oriented protocol X.25 then uses these addresses to move data around the network. The OSI equivalent of TCP is rather simpler than TCP because the connection-oriented X.25 service provides the reliability that TCP itself provides over the unreliable IP. However, even here there are several transport protocols—in fact, no less than five of them, each providing some additional services such as retransmission and multiplexing of several system-to-system channels over a single X.25 connection. (X.25 connections are treated like telephone connections, and billed accordingly. If you can multiplex several streams over a single connection, you save on the setup charges. These are definitely telephone companies we're dealing with here.)

Present It Now!



Instant Full Color 35 mm Slides and Transparencies from Your Desktop

- Instant, full color 35 mm slides and small format overhead transparencies from your SPARCstation with the Polaroid C I 5000 Film printer.
- 4096 by 3600 resolution with 24 bits of color at each dot.
- Print files from any color PostScript application, such as Arts & Letters, with Apunix's NeWSprint driver.
- Sun Rasterfile filter for printing full color images in just minutes.
- SCSI interface attaches to Sun SCSI port for high speed transfer of image data.
- Turn all of your graphs, charts, and text material into eye-catching professional looking 35 mm slides and convenient pocket sized transparencies instantly, quickly, and inexpensively.



(800) 8AP-UNIX

Apunix Computer Services

**5575 Ruffin Road, Suite 110
San Diego, CA 92123**

Voice: (619) 495-9229 FAX: (619) 495-9230
UUCP: ...!ucbvax!ucsd!apunix!sales
Internet: apunix!sales@ucsd.edu

Our Family of products includes: Image Scanners • PostScript Printers • Color Printers
Serial I/O • Telebit Modems • Memory • Disks • Exabyte • DAT • Tape Stackers
Terminal Servers • Ethernet • QIC Tape • Half-inch Tape • Magneto Optical

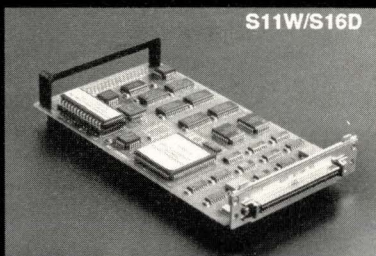
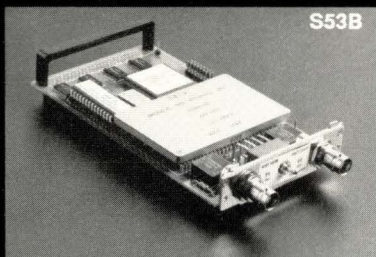
EDT Interface Cards*... the Intelligent Choice***S11W/S16D****S53B****S11W**

- Interfaces with DR11W peripherals
- 16 bit parallel interface
- 8 Mbyte per second transfers

S16D

- 16 bit parallel interface
- Supports buffered block mode with internal FIFO
- 10Mb per second transfers
- Continuous Input or Output

S53B

- Complete MIL-STD 1553B
- 1 MBit per second serial interface
- Supports all mode codes for dual redundant operation
- Configurable as Bus Monitor, Bus Controller, or Remote Terminal

EDT Provides several levels of customer support, from phone consultation to system integration, as well as custom hardware and software design.



1100 NW Compton, Suite 306
Beaverton, OR 97006
Ph. (503) 690-1234
FAX (503) 690-1243

Circle No. 18 on Inquiry Card

There are two areas that serve to point up the difference between the Internet and the OSI ways of doing business, Mr. Protocol feels. The first instance is that of network routing. It is explicitly specified that the X.121 addressing scheme is independent of the geographical location of the systems (except for the branch that uses country codes). Still, routing must be accomplished in the OSI networks. How this is to be accomplished is still a matter for discussion. In the Internet world, it's also a matter for discussion...endless discussion. The problems of intra-network routing gave way to the problems of inter-network routing, which gave way to problems of routing in truly huge networks, which gave way to problems of enforcing policy differences between domains. This is all virgin territory for OSI.

Similarly, although OSI specifies the existence of both connection-based and connectionless network services, there are almost no applications that use the connectionless services (which puts something of a theoretical cast on the schemes to allow the two types to interoperate). The Internet sports several such services, including NFS and the network management protocol SNMP...which is based on specifications that originated with OSI!

Why, then, should any of us bother with any of this? There are several reasons. The first is, like much of OSI, political. The weight of world opinion on networking—"the way we do business"—is based on the PTT model. The national nets of most of the countries of the world are already based on the OSI protocol suite, and they are not about to switch to TCP/IP just because it is more robust and reliable. In addition to the Not-Invented-Here syndrome, in the end they would be limiting themselves, and that's the second reason. There is a large amount of ugliness about the lower levels of the OSI suite, but the application services at the higher levels are better than the equivalent Internet services, in most cases. Whether this is because Internet types joined in the design, or because OSI designers just got better at the

job, or for some other reason, is moot. The fact is that the X.400 Mail Handling System and the X.500 Directory Services specifications beat our own Internet features all hollow in many respects. The fact that they are also much larger, more unwieldy, and difficult to implement goes with the territory. Many folks feel they're just better, and the sooner we move over to using them, the better off we'll all be.

So, in future columns, Mr. Protocol will look at these OSI applications. Why? Because they will probably arrive long before the day that IP gives way to X.25. The smart money now says that, in the short run, the higher-level OSI applications will be deployed over a TCP/IP network, since TCP/IP has much more robust transport and routing protocols, at least for now. People are playing with these high-level applications now. We'll be peeking into that playpen—there are some great toys in there. →

Mike O'Brien has been noodling around the UNIX world for far too long a time. He knows he started out with UNIX Research Version 5 (not System V, he hastens to point out), but forgets the year. He thinks it was around 1975 or so.

He founded and ran the first nationwide UNIX Users Group Software Distribution Center. He worked at Rand during the glory days of the Rand editor and the MH mail system, helped build CSNET (first at Rand and later at BBN Labs Inc.) and is now at an aerospace research corporation.

Mr. Protocol refuses to divulge his qualifications and may, in fact, have none whatsoever. His email address is amp@expert.com.

Did You Miss An Issue?

Back issues of *SUNEXPERT* can be purchased for the low price of \$1.50 per issue (subject to availability) plus shipping. To order, please call our Circulation Department at (617) 739-7001.

EZ-ADMIN sends new Sun users a clear message

New "point and click" menu capabilities for OpenWindows™



Announcing the menu-driven package that makes Sun's SPARCstation administration a welcome asset.

The processing power and brilliant displays of the Sun Microsystems SPARCstations are attracting new users to the world of UNIX workstations every day. This transition has usually meant frustrating hours with a UNIX manual or expensive visits from consultants. Now, for the first time, newcomers to the Sun SPARCstation can set up and administer their own systems from the first day.

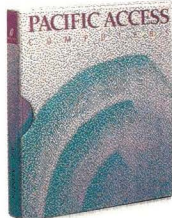

A few of the tasks that EZ-ADMIN makes easy:

By using an intuitive, menu-driven approach, EZ-ADMIN lets you easily:

- Connect to hosts and peripherals.
- Add, update or delete users and access controls.
- Perform network administration.
- Manage mass storage systems more easily.

EZ-ADMIN automatically checks for a broad range of errors. And, there are two levels of password protection to minimize the risk of unauthorized changes to your system.

Pacific Access® Computers regularly updates EZ-ADMIN plus you can easily customize the package to meet your site's needs.

To make your new Sun users feel welcome, send for EZ-ADMIN today.



PACIFIC ACCESS®

COMPUTERS

Making Systems Mesh

2945 Kilgore Road, Rancho Cordova, CA 95670

(916) 635-9300 (800) 648-6161

Offices nationwide



"All brand products and service names mentioned are the trademarks or registered trademarks of their respective owners." Authorized Minority Woman-Owned Business.

Circle No. 31 on Inquiry Card

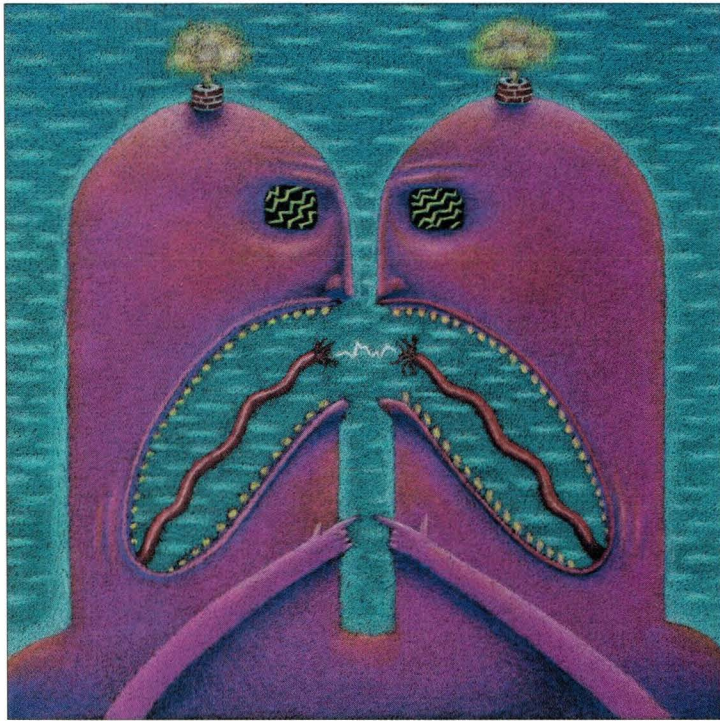

ILLUSTRATION BY KEITH GRAVES

by **PETER COLLINSON**,
Hillside Systems

Program Arguments

One feature that has made UNIX approachable by programmers is the notion that the entire command line is supplied to the running process. A UNIX process is handed a set of text strings containing data that the user has just typed. It is the job of the process to decode the strings and ascribe meaning to them. As a rule, the programmer is free to use the command line in any way that makes sense.

Freedom has meant that typed input varies widely for different commands. Luckily complete anarchy has never quite broken out. Commands on the early UNIX systems mostly followed the convention that an unadorned string was a filename, and an option to the program was preceded by a hyphen. Options are usually a single character.

There are some notable exceptions to this, `find` and `dd` being the ones that readily spring to mind. Many commands dictate that the first argument must always be an option or a set of options.

The `tar` and `ar` commands use this convention. Many commands make the order of arguments on the command line significant, `cp` for example. Others do not.

In BSD-derived systems, it's often possible to omit the preceding hyphen from the list of options. For example, you

can type:

```
% ps ax
```

rather than:

```
% ps -ax
```

The ability to do this depends on the whim of the programmer whose code makes sense of the options. The `ps` command *knows* that the first argument is always a set of options and so the hyphen can be omitted. Also, the `ps` command is one of the commands that uses the order of the arguments to imply what they mean. This is convenient, but counter-intuitive. If you separate the options:

```
% ps -a -x
```

which you might think is reasonable, then you get the mysterious message:

```
ps: cannot open -x: No such file or directory
ps: could not read kernel VM for -x
```

Take a graduate course in productivity.

If you want to get even more out of your Sun™ system, why not learn from the company that's already at the head of the class.

We're the industry leader in RISC/UNIX® technology, so it's no surprise that your first choice for UNIX training is Sun Educational Services.

The fact is, you give us the highest grades in surveys and course evaluations year after year. And the subjects include virtually everything we do, from course design and instruction to our comprehensive course materials, not to mention our convenient locations. All of which is undoubtedly why we've trained more people on UNIX than any other workstation vendor.

Whether you visit one of our 37 authorized training centers around the world, invite us to your site, or try our new *Self-Paced Learning Series*, you'll get the ideal balance of top quality instruction and hands-on work.

For more information on how Sun Educational Services can increase your productivity, contact your nearest sales office. In the United States, simply call 1 800 422-8020.

And get the higher education in UNIX that tops everything else in the business.



because `ps` knows that argument 2 is a program binary.

The potential for anarchy was held somewhat in check by a dictum of AT&T. Sometime in the early 80s, a piece of paper fluttered down stating that from henceforth all command line input will obey some rules. These particular commandments were later enshrined in the System V Interface standard, the SVID. By the process of standards osmosis, the rules are now part of POSIX.2, the shells and utilities standard. This isn't a standard yet, but they are balloting it. It's the natural order of things that the rules are slightly different in POSIX.2 from the version in the SVID.

From the beginning, the rules have not been mandatory. They have always stated that people must use them in the future but need not change existing programs. They are not even mandatory in POSIX.2. Both the SVID and the standards text make heavy threatening hints about the consequences of ignoring the guidelines when constructing commands. However, the rules have often been ignored. Ten years of habits are hard to break and I expect that people will continue their own merry way.

Mechanics

Where does this flexibility come from? How does all this work? Let's look at the creation of a new process. The `fork` system call is used to make a new process. It creates an exact copy of the calling process.

After a `fork`, there are two identical processes running in the machine. The newly made process invokes the `exec` system call to load and run a new program. The `exec` call throws away the bag and baggage of the old process: the program area, the data segment and the stack. It starts to make a completely new process image. There are many variants to the `exec` system call, all presenting a slightly different interface to the caller. The term "exec system call" is generally used to refer to the whole family. On a Sun, there is only one real system call, `execve`, and all the other routines call that. The actual implementation is system dependent and it's easier to think of the whole `exec` family as a set of system calls.

The `execl` variant of `exec` is convenient for use in C programs. If a process wished to become the `echo` program with some arguments, then the calling C program might look like:

```
execl("/bin/echo", "echo", "These", "are",
      "program", "arguments", 0);
```

The arguments to the routine are all strings. The end of the argument list is shown by a zero value. The first mandatory parameter to the `execl` call gives a pathname to the file that contains the binary image of the new program. The second parameter is mandatory by convention. It contains the name of the program being run. The remaining strings are all arguments to the program.

The system arranges that all arguments but the pathname are parcelled up and passed into the target command. By convention, all C programs start with a routine called `main` that has two parameters. The source for programs that

decode arguments will look like:

```
main(argc, argv)
int argc;
char *argv[];
```

The first argument is an integer giving the number of arguments that are passed into the program. The system creates this by counting the strings that it has been given. The second argument is a pointer to a vector of pointers to strings. This is perhaps a bit plainer if you look at the figure below. The name of the command finds its way into the first argument. In C it is numbered zero, so we think of it as the zero'th argument.

Having this name may seem unnecessary, after all the programmer doesn't need to be told the name of the command. It turns out to be useful. For example, several programs on the system are actually the same binary but behave differently when started with a different name. The editor, `vi`, has several variants: `ex`, `view`, `edit` and `vedit`. These are all links to the same binary that uses the name to give different behavior when the program is run.

The Kernel

In reality, the `exec` system call passes two sets of strings into the new process. As we have seen, the first set is the program arguments. The other set forms the environment of the process containing information like:

```
SHELL=/bin/sh
```

I won't dwell on the environment strings. They are treated in the same way as the program arguments.

The argument strings are passed like the `argv` form that is shown in the figure below. The `execl` routine in the caller has to do some work to create the vector of pointers to be passed into the actual `execve` system call. What happens next involves some work for the kernel.

The kernel needs to make sure that the arguments arrive

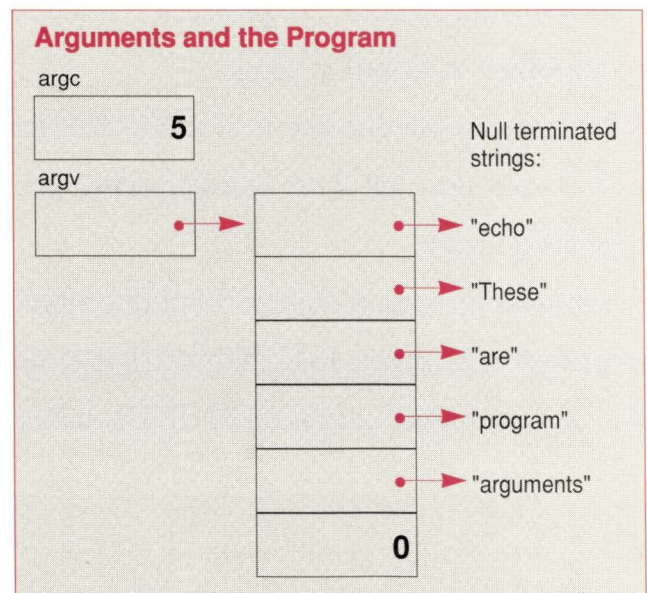

Datalink is an Authorized Distributor of



SUN PERIPHERAL STORAGE SUBSYSTEMS

Full SUN Compatibility
SCSI Interface
Easy Installation
Custom Configurations
Available

HARD DISK DRIVES:

- 397 Mb, 795 Mb, 1.18 Gb, 1.60 Gb and 2.0 Gb Capacities
- Average Seek Times as Low as 11ms
- Latency as Low as 5.56 ms
- Up to 200,000 Hour MTBF
- 5 Year Warranty

DIGITAL AUDIO TAPE (DAT) DRIVES:

- Up to 8Gb Capacity
- Standard Digital Data Storage (DDS) Format
- Standard DCLZ Data Compression Available
- Industry Leading 50,000 Hour MTBF

OPTICAL DISK DRIVES:

- Re-writable and Multi-function Magneto-Optical (MO) Drives
- Continuous Composite Media Meeting ISO/IEC and ANSI Standards
- 650 Mb per Cartridge

8mm TAPE DRIVES:

- Up to 5Gb Capacity
- Up to 500Kb/s Sustained Transfer Rate
- 8 mm *de facto* Standard



Datastor Subsystems feature disk, DAT, and optical drives by Hewlett-Packard

1-800-448-6314



Minneapolis Office
7423 Washington Avenue S.
Minneapolis, MN 55439
Phone (612) 944-3462
FAX (612) 944-7869

Chicago Office
2500 Higgins Road
Suite 1142
Hoffman Estates, IL 60195
Phone (708) 882-1244
FAX (708) 882-1248

St. Louis Office
1715 Deer Tracks Trail
Suite 230
St. Louis, MO 63131
Phone (314) 965-7750
FAX (314) 965-7832

Circle No. 14 on Inquiry Card

in the new process looking like arguments to the `main` routine. When we are compiling a program, the C compiler will not do anything special for the main routine. The code that is generated will expect to access its arguments in the same way as any other routine in the program. This means that the kernel has to fake a routine call with appropriate arguments. This is architecture dependent but often means that the arguments will be placed at the base of the stack of the new process.

The other problem that the kernel has to resolve is one of address space. The `exec` call throws away all the address space of the old process and needs to create a new one for the new command. The program arguments have to be moved from the old address space to the new. This is done by copying the arguments from the caller process into the kernel before the old caller address space is destroyed. A new stack segment is made and the arguments are then copied from the kernel into the new process.

It is hard to avoid this two-stage operation because the `argv` vector in the caller can point to strings spread throughout the caller's data area. It is also not possible to know how much space is needed to store each argument.

Early systems copied this argument data into empty kernel space provided by the disk-buffering system. The `exec` system call allocated some swap space for the copying exercise. Data was then copied into kernel disk cache and written to disk if buffers were scarce.

There was a top limit of 10 KB of argument list data. This was often easily exceeded by using the shell's file name expansion mechanism. Failure could result from typing something like:

```
$ ls /some/long/path/name/*
```

where the target directory contained many files. There was not enough space to store the arguments to the `ls` command. The strategy was to not use the argument line:

```
$ cd /some/long/path/name
$ ls
```

This worked for listing the directory with `ls` but could fail if you wanted the shell to generate an argument list for some random command. You had to use commands like `xargs` to reduce the number of bytes in the argument list.

As you might imagine, `exec` failure due to insufficient argument space can be embarrassing, especially for shell scripts. They will work fine until one day a file will be created that pushes the argument list byte limit over the top resulting in the death of the script. Groan.

Current systems use virtual memory to provide "infinite" storage for argument lists being passed in the `exec` call. There is some upper limit on the number of bytes that may be passed, but the limit is rarely reached.

Decoding Arguments

Having got the arguments safely from one process into a new one, the kernel will start it running. The main routine

of most programs contains a section that decodes arguments. In the early systems there was no routine supplied to do this. People wrote their own decoding code. This was the reason for the proliferation of different styles of arguments.

These days most people will use the routine `getopt` to decode arguments. This removes some (not all) of the drudgery of programming argument decoding routines. The routine looks for program options, argument strings starting with a hyphen. The rules state that program options should precede any other arguments. The `getopt` code expects to be used like this and will stop when it finds an argument that does not start with a hyphen.

The `getopt` routine takes three arguments. The first two are simply passed in from the `main` module; they are `argc` and `argv`. The last argument is a selection string containing a letter for each option that the program expects to find on its command line. If we want to create a command that permits the letters "i," "p" and "r" as options, then we would call `getopt` like:

```
rv = getopt(argc, argv, "ipr");
```

When called, the routine looks in the `argv` for a legal program option. If it doesn't find one, it will return minus one. We expect to use `getopt` in a loop so that it will scan several arguments until it finds one that doesn't start with a hyphen.

When a legal option is found, the routine will return the letter that matches a character in the selection string. If the option is `-p` then `getopt` will return the character "p." If the character in the argument list is not present in the selection string, then `getopt` will return the question-mark character and will also (optionally) print an error message. Here is the beginnings of a template to use this:

```
main(argc, argv)
int argc;
char *argv[];
{
    int rv;

    while ( (rv = getopt(argc, argv, "ipr")) != 1)
        switch (rv) {
            case 'i':
                /* got i */ break;
            case 'p':
                /* got p */
                break;
            case 'r':
                /* got r */
                break;
            case '?':
                /* error */
                break;
        }
    /* working code */
}
```

The comments are intended to represent working code, setting some variables to remember that the particular option had been used. The operation of the code is simple. The `getopt` routine is called repeatedly until no more options exist on the command line. Each time a legal value is found, it is returned into the `rv` variable. This is passed into the switch statement for decoding.

This program will accept arguments like:

```
-i -p
-ip
-p -i -p
```

In the first line, the options will be in separate strings, pointed to by different entries in the `argv` vector. The `getopt/switch` loop can happily ignore that. In the second line, all the letters are bunched in one argument. This is equivalent to the first line. The appropriate cases in the switch will be executed however the data is input. The ability to use both forms is common and the rules about arguments have always protected this right to redundancy. On the third line, the `p` option has been used more than once. The `getopt` routine will not treat this as an error. If you consider this an error, then you should arrange to have some code in the switch complain bitterly.

End of Arguments

The original set of rules postulated that a special argument, `--`, ends the interpretation of options. For example:

```
% touch -g
usage: touch [-amcf] file ...
```

will not make a file called `-g`, because `-g` is treated as an option to `touch` and rejected. But when the magic end-of-option marker is used:

```
% touch -- -g
% ls
-g
%
```

the `-g` string becomes an argument to the program and is treated as a file name.

The `getopt` routine implements this, but many programs still exist that do not follow this rule. When trying to delete the file, you might fall into the trap of thinking that a `--` argument to `rm` might work. It doesn't.

```
% rm -- -g
usage: rm [-rif] file ...
```

The `rm` command is already blessed with a way of removing files that start with a hyphen:

```
% rm -g
```

We must conclude that `rm` on the Sun doesn't use `getopt`. All this discussion of creating and deleting files that start

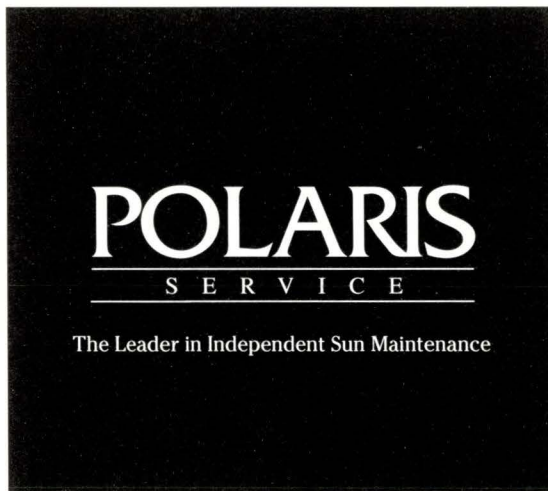

For more information, call 800-541-5831

**MAINTENANCE
FOR TODAY'S
TECHNOLOGY**

The pace of new Sun product introductions is faster now than ever before. Polaris, more than anyone else, responds by continuing to invest in the latest parts, repair technologies and skills. We offer plans that reflect the high reliability of today's Sun systems, and include the training and technical support you need, whether you are an end-user, self-maintainer, VAR or TPM. Since 1986, we've been providing service for some of the most demanding Sun users. We can do it for you.

Corporate Headquarters:
399 River Road, Hudson, Mass 01749

Contract Maintenance • Self-Maintenance • Repair and Parts • Training and Support

with a hyphen may seem irrelevant, since it is something that you will never *seek* to do. The `--` operator is occasionally useful and can be worth knowing about. It's always good to have ways to circumvent conventions that might prohibit some action or other.

Options With Arguments

We sometimes want to give an option that requires additional information. Perhaps we want to say "start logging into this file" something like:

```
% mycmd -l /usr/adm/log srcfile
```

The `getopt` routine deals with this by allowing you to add a colon into the selection string after the appropriate character. The colon means "this option is always followed by an argument." To add our new logging argument into the example above, the `getopt` selection string is changed to:

```
"il:pr"
```

Alphabetic order is not mandatory but can save grief later.

If the user supplies a `-l` option, the calling routine needs to know the value of the argument to the option. The `getopt` routine employs an external character pointer called `optarg` to point to the current value of the option argument. To decode the option, we will add something like:

```
case 'l':
```

```
log = optarg;
break;
```

into our switch statement. The value from the arguments is picked up and stored in something that we will use later. We don't need to worry about storing the string pointed to by `optarg` because it already exists in static storage in the argument vector.

The version of `getopt` on my Sun allows you to give an argument to an option without intervening white space. For example:

```
-l/usr/adm/log
```

Grouping options is permitted, so

```
-il/usr/adm/log
```

is allowed. However, the option with an argument must appear as the last entry in the string on the input line.

Dealing with Other Arguments

When `getopt` finds a string that doesn't start with a hyphen, it will assume that it has arrived at the end of the program options. This enforces the rule that program options must come on the command line before any other program arguments.

When this happens, there may be other arguments to decode and the programmer needs to know where they start.

Your SPARC Workstation.

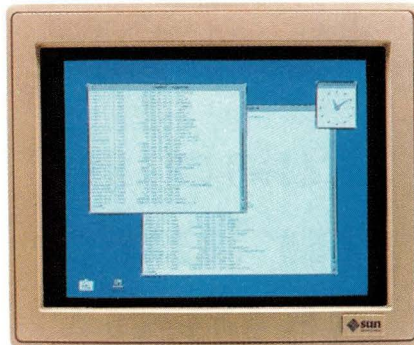

Your SPARC Workstation With SoftPC.



Any Questions?

Now, enhanced SoftPC[®] VGA delivers VGA graphics to your SPARC workstation. Run your favorite DOS applications and enjoy the power, multitasking, centralized security and networking capabilities of your workstation. Then add the high resolution graphics to enhance DOS-based CAD, paint, or mapping programs.

See your classic SPARC workstation in a new way — in vibrant color with SoftPC VGA. Call us today for more information: 1-508-682-7600.



Insignia[™]

Insignia Solutions Inc., 6 Campanelli Drive, Andover, MA 01810

SoftPC is a registered trademark of Insignia Solutions Inc. SPARC is a trademark of SPARC International, Inc.

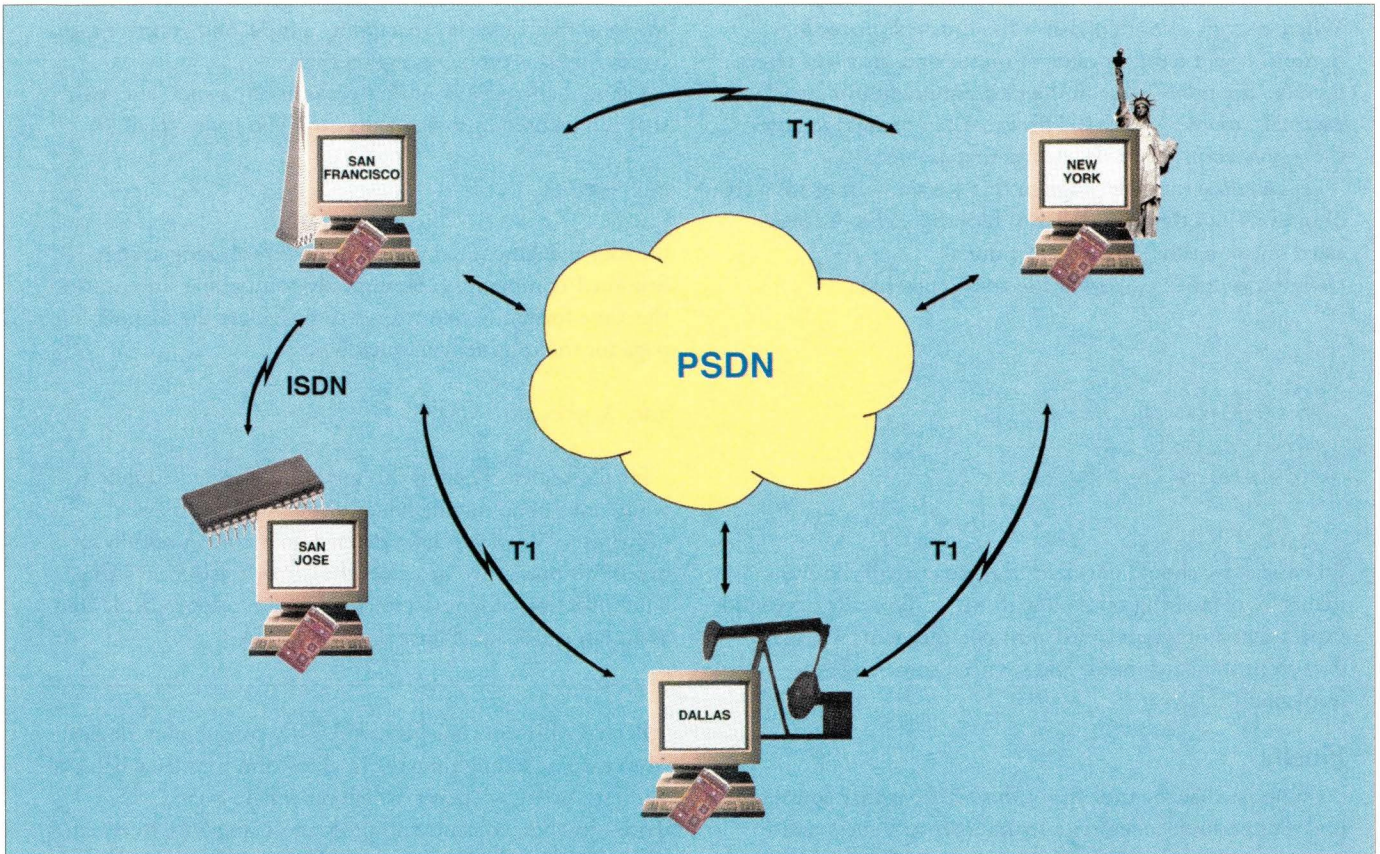

Internetworking with Themis' SXCM Sbus Controller Card

Sbus Controller Plugs You Into High Speed Data Networks

No remote bridge boxes are needed to connect your Sparcstations to high speed worldwide public and private Packet Switched Data Networks (PSDNs). With our SXCM Sbus X.25 controller and Tcomm-X.25 software your Sparcstations can be used as internet routers, linking local TCP/IP LANs with remote LANs via X.25 PSDNs.

Tcomm-X.25 allows Sparcstation users to transparently share applications, databases, printers and files with remote systems.

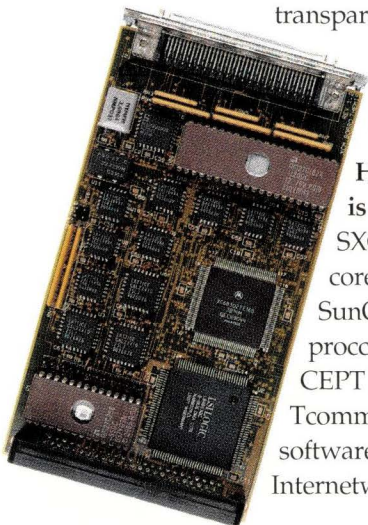

High speed networking is our specialty. The SXCM's 68302, 20 MHz 68000 core processor off-loads SunOS from much of the processing required by T1 and CEPT rate WAN traffic. Tcomm-X.25 communications software is complemented by our Internetwork Protocol Router,

Tcomm-IPR. Tcomm-IPR uses the SXCM high performance Sbus communications controller to interconnect remote Sun Sparcstations through wide-area transmission facilities. Tcomm-IPR transparently supports all TCP/IP services and employs Point-to-Point Protocol for compatibility with routers from other vendors.

If your application requires ISDN, DS-3 or SMDS connectivity ask us about our other communications products.

Call (510) 734-0870, fax: (510) 734-0873, or in Europe, 33.76.59.60.61, fax: 33.76.63.00.30.

When it comes to high speed internetworking, Themis has the hardware and software to put it all together.

At Themis, we're making the open systems promise a reality.

Americas: 6681 Owens Drive, Pleasanton, CA 94588
Europe: 29, Av. de la Baltique, 91953 Les Ulis Cedex-France

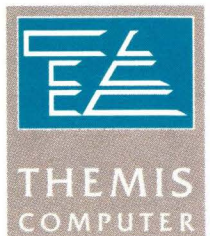

When `getopt` considers that it has finished processing options, it will return a value of minus one. As a side effect, it places the index value of the next argument into another external variable: `optind`. This value can be used to access the `argv` vector to get the strings that are needed.

Let's assume that the program that we are writing has a set of options and then a number of files that are to be processed one at a time. After the comment `/*working code*/`, we will add some code like:

```
...
...
/* working code */
while (optind < argc)
    doit(argv[optind++]);
}
```

Of course, we should check for the presence of the arguments by comparing `optind` with `argc`. Typically we would expect that a program called with no arguments will take data from standard input, and we need some code to implement this.

Finally

I suppose that the message of this article is that you should use `getopt` to decode program arguments. I guess that I sometimes do. I should use it more often. The trouble is that it doesn't offer much more to me than the usual decod-

ing loop that I use. It saves typing a little, and enforces the "rules." This is probably a good thing.

I should also point out that versions of `getopt` also exist that can be used in shell scripts, so if you have typed

```
man getopt
```

on your machine, then you are probably looking at the Section 1 command. It is culturally compatible since it uses the same format for selection strings. To get the manual page for the routine, you must type:

```
man 3 getopt
```

Finally, a plea. There is this guy in the United Kingdom whose idea of an intelligible error message is somewhat unhelpful. When you have entered an incorrect option to one of his programs, he prints the `getopt` selection string. The collection of letters and colons leaves a lot to be desired as an error message. Please don't do it. ➡

Peter Collinson runs his own UNIX consultancy, dedicated to earning enough money to allow him to pursue his own interests; doing whatever, whenever, where ever. ... He writes, teaches, consults and programs using SunOS running on a SPARCstation 1+. He is the Usenix Standards Liaison. Email: pc@expert.com.

Reader Feedback

To help *SunExpert* serve you better, take a few minutes to close the feedback loop by circling the appropriate numbers on the Reader Service card located in the back of this magazine. Rate the following column and feature topics in this issue.

	Interest Level		
	High.....	Medium	Low.....
Features:			
Graphics II: Software	168.....	169.....	170.....
That's Entertainment	171.....	172.....	173.....
An Island in the Sun	174.....	175.....	176.....
Columns:			
Ask Mr. Protocol—The Other X:			
International Cooperation and Its Horrors	177.....	178.....	179.....
UNIX Basics—Program Arguments	180.....	181.....	182.....
I/Opener—A Look at Software Distribution	183.....	184.....	185.....
Your Standard Column—FORTRAN? Yes, FORTRAN	186.....	187.....	188.....
Systems Administration—Imake: Friend or Foe?	189.....	190.....	191.....

Bare.



Your basic 8mm drive

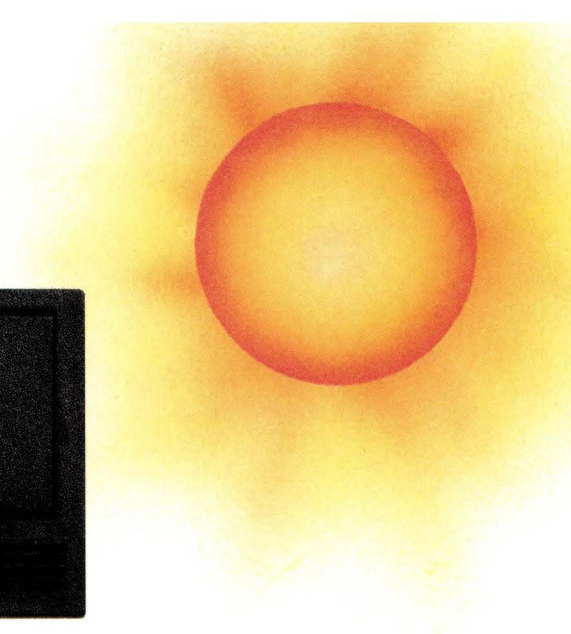

Essentials.

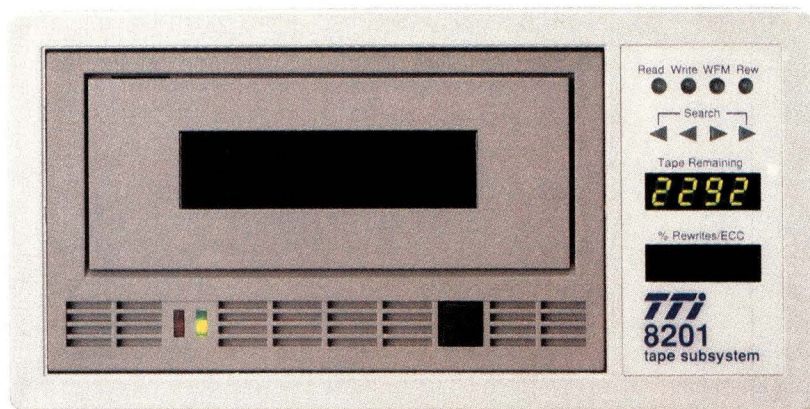

The fully instrumented TTI 8201

Which would you rather have, prices being equal?

A generic, bare-bones 8mm drive?

Or the fully instrumented TTI?

If you choose the generic, you'll get a great drive and an on-off light.

Pick TTI, and you'll get the same great drive and on-off light, **plus** a brilliant on-board display with real-time information on tape capacity, ECC error correction usage, read/write rate, and tape status.

Undecided? Here's more.

TTi's CTS-8201 and CTS-8501

8mm helical scan tape subsystems are high performance workhorses with the capacity workstations demand: up to 5GB fits on just one low cost tape. And it has the speed you need, with data transfer rates of up to 30 MB per minute, nothing is faster.

So when it's time to add 8mm tape backup to your Sun 3, Sun 4 or SPARC workstation, don't settle for a bare bones drive. For about the same price you can own a TTI CTS-8201 or CTS-8501 with a display users consider absolutely essential.

For more information, call or

write: Transitional Technology, Inc., 5401 East La Palma Ave., Anaheim, CA 92807. Phone: 714-693-7707. FAX: 714-693-0225.

In Europe, call Transitional Technology, Ltd.: (44) (295)269000.



Backup so easy, you can do it with your eyes closed.

TTi
TRANSITIONAL
TECHNOLOGY, INC.

A typist can type this much in four seconds.

A four-second argu

In four seconds, ScanWorX can scan everything you see on this page into your Sun workstation.

In terms of productivity, that means in just one day with ScanWorX, you can input 1,000 or more pages of information. On a good day, an average typist can input only 33 pages. Making it easy to see how ScanWorX makes your Sun workstation extremely productive.

But ScanWorX is much more than just a fast scanner. It's a complete document input system that uses Intelligent Character Recognition software to

A flatbed design allows scanning of documents up to 11"x17". And the automatic document feeder holds 50 double-sided sheets of paper.

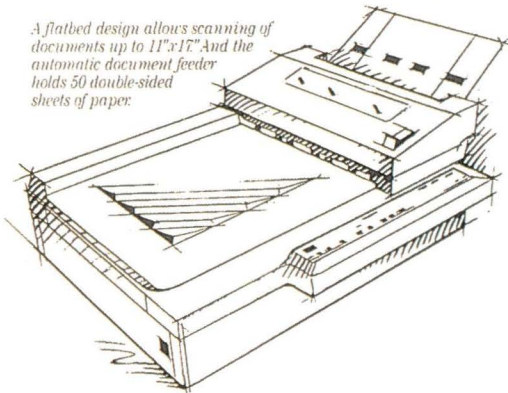

quickly and accurately convert mountains of documents into electronic files. And access to those files is as close as your fingertips.

If ScanWorX doesn't recognize a character, it will continue to process the document, actually "learning" as it goes along.

Then, it applies this knowledge throughout your document for maximum accuracy.

Our exclusive interactive Verifier gives you the ability to cleanly scan faxes, photocopies, dirty documents or documents with multiple columns or a mix of typefaces. And all without the need to do any additional post-editing.

But ScanWorX doesn't stop there.

For documents with a mix of text and images, our on-screen zoning with Preview allows you to easily identify and select different zones for processing. ScanWorX then automatically outputs them into the correct formats.

What ScanWorX does with a document after processing is just as impressive. Because it converts documents directly into software applications for the Sun system. Such as Interleaf, FrameMaker and WordPerfect. And since ScanWorX software can be shared on the network, those files can be accessed from multiple Sun workstations.

For details on how to make your office more productive, call (800) 248-6550. It will only take a few seconds. Much like ScanWorX.



©1991 Xerox Imaging Systems, Inc. ScanWorX is a trademark of Xerox Imaging Systems, Inc.

ment for ScanWorX.

Circle No. 49 on Inquiry Card



ILLUSTRATION BY ROBIN JAREAUX

A Look at Software Distribution

by RICHARD MORIN, Technical Editor

A great deal of software is given away. The Internet archives contain tens of gigabytes of downloadable data, much of which is computer software. The Free Software Foundation (FSF), Sun User Group, UUNET and several other institutions distribute collections of redistributable software.

None of this software is supported by the distributors, however, and most of it requires a fair amount of installation, customization and support. In addition, new versions come out occasionally, and should be installed, tested and released to the local user community. Sites normally delegate one or more programmers to keep their freeware running and current, accepting the cost of this labor.

Alternatively, individual consultants and organizations are available to support some of these packages, for a fee. Ron Guilmette is a Sunnyvale, CA-based consultant specializing in C programming tools. He provides development and porting services for freeware tools such as GCC and GDB, as well as for commercial packages such as AT&T's Cfront (C++ to C converter).

Ron makes an interesting comparison between the software and automobile industries. Commercial software is similar to an automotive lease. The vendor provides a great

deal of service, and the customer has few responsibilities.

Freeware is more like an automotive purchase. The customer is responsible for more, but has far greater freedom in using or modifying the product. Ron's position is thus similar to an independent garage, save that most garages don't contribute design features back to the factory. Indeed, freeware is characterized by the fact that its supporters also tend to be its developers. Cygnus Support, using the same analogy, is an authorized dealer. The company's principals are major contributors to a number of FSF packages. In addition, some of Cygnus' employees are the official maintainers for several FSF packages, including G++, GCC and GDB. Cygnus offers commercial support for various FSF (GNU) packages. The service is not inexpensive, but the firm is very good at what it does.

Several large sites now substitute Cygnus' efforts for their own. In addition, vendors such as 3Com, AMD, Intel, Sun, Telebit and Wind River have chosen to have Cygnus support all or part of their GNU code. Notably, all code developed by Cygnus goes back to the FSF for possible integration into GNU releases.

Complying with Cygnus' motto ("If it isn't source, it isn't software"), most UNIX freeware is distributed in source

Not only do they remember, they never forget.



As intermediate and long-term data storage technology advances, so does your need for a qualified, full-service systems integrator. Since 1986 Computer Upgrade has been providing leading edge, optical data storage solutions for a wide range of applications. For a memorable solution to your data storage and retrieval needs, call Computer Upgrade today.

- ▶ Multi-host support including: Apple, DEC, IBM, and Sun.
- ▶ Both stand-alone & auto-changer sub-systems available.
- ▶ Complete standard file structured disc emulations.
- ▶ Interchangeable file systems available.
- ▶ Providing both OEM and End-user solutions.
- ▶ National installation & maintenance available.



Computer Upgrade Corporation

2910 East La Palma Avenue, Building A
Anaheim, CA 92806
(800) 874-8807 • Fax: (714) 630-9254

An authorized  PIONEER distributor

Company names and logos are trademarks of their respective holders.

Circle No. 10 on Inquiry Card

form. This provides flexibility and portability, at some cost in effort by the recipient. In addition, source code allows the recipient to scan the program for possible security problems. In an effort to combine convenience with the virtues listed above, the Sun User Group has issued a CD-ROM containing both source and binary versions of hundreds of popular UNIX freeware packages. Contact SUG at (617) 232-0514 for more information.

The availability of a substantial amount of real, free use will justify the effort of installing a desired software package.

Outside of formal freeware distribution, the path can get a bit muddy. It can be difficult to find the current version of a useful package. The archive wizards of the Internet are working on solutions, however, and things should improve substantially over the next few years. Automated archive indices, package reviews and registration of version are being discussed and/or tried.

Priceyware

In any event, freeware is not the norm in software distribution. Most commercial sites purchase (lease, etc.) the software they need for mission-critical tasks. They demand (and usually get) on-call support for installation, and sometimes, continuing operation of the packages.

Historically, this purchase involved a complex set of interactions between the buyer and seller. With thousands of dollars at stake, buyers needed to be thoroughly convinced before purchasing a package. A ritual of literature exchange, telephone or personal calls, demonstrations and contracts thus ensued. Unfortunately, the client seldom had any real access to the package.

The advent of CD-ROM software distribution, however, has changed the game a bit. A prospect pops in the CD-ROM disk and tries out a sample version of the software. If satisfied, the prospect can purchase the software over the telephone, in a matter of minutes.

In some cases, the customer must then wait for the software and documentation to be shipped. More frequently, they are given a key that unlocks a real copy of the package. Mary Jo Foley's article, "Need UNIX Apps?" (*SunExpert*, October, Page 60), surveys mass-market distribution channels for UNIX software.

Licensing

In the simplest case, the client gets the indefinite right to use the package on a single machine. More complicated arrangements may allow use on all machines at a given site, perhaps with a limit on total simultaneous usage. The proliferation of network-licensing systems attests to the desire (at least by vendors) for this sort of control.

Briefly, network-licensing systems provide secure, reliable control of software-package usage. One or more license servers give out usage tokens, monitor whether the packages are still running and generally keep track of how many copies are currently in use on the network. Alan Pope's article, "An ISV's Overview of SunNet License" (*SunExpert*, October 1990, Page 60), is a technical look at Sun's network-licensing system.

Network licensing fits well with clients' needs to control their budgets. The client "buys" the right to have N copies of the software running at the same time. If usage is relatively even, no major hassles result from this scheme. The available licenses cover typical needs, and most conflicts can be handled by a bit of scheduling and/or cooperation among the users.

The system falls down, however, if usage is peaky. Suppose that a company uses a desktop-publishing package to develop sales literature, user documentation, training materials, etc. Months may pass with little usage, followed by a frenzy of usage when a new product is being finalized. Should the company buy for the low spots, the crises or what?

Alternatively, a very small company may need a package only infrequently. A consultant may need a package for several weeks, then never use it again. If the cost is too high, the user will choose to do without the package. Nobody is happy in this scenario. The company loses the use of the package, and the vendor loses possible revenue.

Pay-As-You-Go

A solution exists, although I have not seen it proposed, let alone offered commercially. By a simple modification of the licensing software, clients can be allowed to purchase usage as desired. An initial phone call gives the client a trial period, perhaps 40 hours. Support, beyond a modicum at installation time, can be charged separately.

The availability of a substantial amount of real, free use will justify the effort of installing a desired software package. If the package serves the client's needs, the initial allotment will soon be used up. Local users will then demand an extension of the contract.

The client can buy further usage allotments as needed. The allotments will tend to converge on a comfortable size fairly rapidly, balancing hassle against cash flow. By keeping a moderate amount of usage available at all times, the client can have continual availability of the package, at minimum cost.

If demand stays high, the client and vendor may wish to switch to a more conventional licensing agreement. Some form of lease-option might even be written into the initial contract. By adjusting costs to clients' needs, vendors can

gain clients who might otherwise be lost. Clients gain economical access to desired packages, increasing their productivity. This seem like a win-win situation, and I predict that something like it will emerge soon.

A closely related idea, time averaging, takes care of peaky usage, while preventing runaway usage. A license server can start with $10 \cdot D$ tokens, give out D tokens per day, and deduct H tokens per hour of usage. Tokens accumulated during periods of low usage automatically balance the needs of high usage periods. Over time, the D s and H s must stay in line, but the constraints are much more congenial than those of current "N simultaneous user" regimes.

Pay-as-you-go can be combined with time averaging in a useful manner. Let's say a site has an unusually high need for a package for a limited period of time. Rather than increase its license, it can buy blocks of tokens. These supplement the normal supply, carrying the site through the crisis. If the increased need continues, the site can upgrade its license.

Security

Many companies are now starting to police their (mis)use of commercial software. The advent of punitive damages for intentional misappropriation of software may have something to do with it. Then again, it might be caused by a maturing of users' attitudes. In either case, it is a welcome change.

Regardless, there are some companies and individuals who still regard all software packages as fair game. In retaliation, some vendors use complicated (nay, baroque) sets of files, keys and processes to ensure that their software will never be used by an unauthorized party. This seems to me to be an over-reaction.

Most commercial sites will not spend significant effort on breaking the security provisions of software packages. They may try a few simple tricks, but they will give up long before disassembling the package. The return simply does not justify the effort and risk involved. (It is hard to explain how you accidentally used `adb` on a commercial package, disabling its security checks.) Any organized effort to break the security of commercial software would fall prey to RICO statutes and the like.

Consequently, security provisions do not normally need to be totally bulletproof. This means that they can be optimized for the convenience of system administrators. Vendors should examine their installation and maintenance procedures, changing those that are excessively difficult or tedious. Customer satisfaction will outweigh any probable loss to pirates.

Another Idea

Truly secure network licensing cannot be based on software that runs on general-purpose computer systems. There are far too many forms of attack for this method to be reliable. I therefore suggest (for those vendors that care) that a separate box be made available to serve as a license server.

Hermetically sealed, it could only be accessed by `rlogin`,

and would totally control its own internal environment. Using encryption keys, etc., it could provide a wide range of licensing services for a large number of packages. The necessary hardware is minimal: A microprocessor, some non-volatile memory and an Ethernet interface. I suspect that the units could be sold (in reasonable quantities) for a few hundred dollars each. ➔

Richard Morin may be reached at Canta Forda Computer Laboratory, P.O. Box 1488, Pacifica, CA 94044. His electronic address is `cfcl!rdm@apple.com`, or he can be reached at `rdm@expert.com`.

Vendors

Cygnus Support

814 University Ave.
Palo Alto, CA 94301
info@cygnus.com

Free Software Foundation

675 Massachusetts Ave.
Cambridge, MA 02139

Sun User Group Inc.

1330 Beacon St., Ste. 315
Brookline, MA 02146
office@sug.org

UUNET Technologies Inc.

3110 Fairview Park Drive,
Ste. 570
Falls Church, VA 22042
uunet@uunet.uu.net

The End of the CD-ROM Shuffle!



The DJ-6 from Tracer Technologies 6-Disk CD-ROM Changer for SPARCstations and Servers

- Supports all High-Sierra, ISO 9660, and Audio CDs
- Simple SCSI add-on
- Uses the Pioneer DRM-600, the industry's leading CD-ROM changer
- Audio output (RCA and mini-headphone jacks) with volume control, works with Sun's audio CD tool
- Includes cables, terminator, SunOS driver, caddy

Tracer Technologies
19584 Clubhouse Road
Gaithersburg, MD 20879

(800) 872-2370
(301) 977-1398
FAX (301) 869-7033

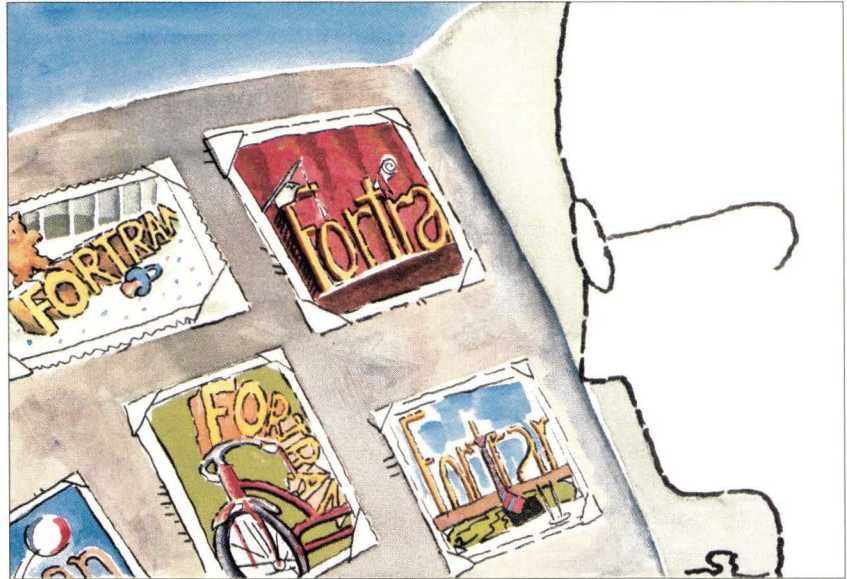

ILLUSTRATION BY S. H. LEE

by PETER H. SALUS

FORTRAN? Yes, FORTRAN

In the mid-1950s, a group headed by Jim Backus at IBM Corp. in New York was investigating an “algebraic language translator.” By the end of 1956 we had FORTRAN (for FORMula TRANslator) 0. It was not the FORTRAN we know today (though it was the first programming language I studied, over 30 years ago). Among other things, there were no FORMAT statements and no user-defined functions.

Just about the time the FORTRAN 0 compiler was being completed, FORTRAN I and FORTRAN II were being designed. Backus and his colleagues announced FORTRAN at the 1957 Western Joint Computer Conference of AIEE (now IEEE), and it achieved instant popularity. (Backus has outlined the history of FORTRAN I, II and III in Sigplan Notices (August 1978), and I refer anyone

really interested in the history to that 15-page article.)

POSIX and FORTRAN

While POSIX started with UNIX as a model, POSIX standards are not limited to UNIX. For example, DEC has announced a program that will incorporate some of the POSIX standards into VMS. Once adopted and implemented, POSIX standards will define a broad range of compatibility both within the UNIX family of operating systems and between other operating systems.

ISO requires that functionality be specified by language-independent standards. That is, standards specify functionality without specifying interfaces or syntax. Thin binding standards are then produced for each language to provide access to the functionality. Because of the wide use of FORTRAN in computing generally, P1003.9 was established

to provide access to the POSIX-defined, standard operating system interface and environment directly from the FORTRAN language. In the last year, ISO has relaxed its restriction to allow thick C bindings that define new functionality, but has excluded all other language bindings that do not reference a language-independent standard. Even though .9’s proposed FORTRAN binding is a thin binding, it is based on the thick C binding and not a language-independent specification as required by ISO. (This is because there is no language-independent specification and such a specification could be a year or more away.)

As a consequence, the .9 working group will forward its draft to IEEE and to ANSI for processing when its work is complete. The group intends to ask ISO whether it wishes to adopt the IEEE standard at that time. This

will give ISO another chance to say yes or no. In the event that ISO says no, it may be several years before a language-independent standard is developed and a binding to it can be produced. The proposed binding will be of use to the FORTRAN community today, as will an ANSI standard, even in the absence of an ISO standard.

Which FORTRAN?

One of the issues confronting .9 a year ago was which FORTRAN to use. The obvious choices were:

1. FORTRAN 77 [ANSI X3.9-1978, ISO 1539-1980 (E)],
2. a codification of common extensions/enhancements to FORTRAN 77, or
3. the revised FORTRAN standard emerging from the ANSI X3J3 committee—previously referred to as FORTRAN 8X, but now called Fortran 90.

The committee chose the first.

For FORTRAN 77 versus Fortran 90, the determiner was that FORTRAN 77 is currently the only adopted standard. (Fortran 90 is scheduled to be adopted as an ANSI standard after P1003.9 goes to ballot.)

Thick Versus Thin

The FORTRAN binding to POSIX is referred to as a "thin" binding. That means that it defines the FORTRAN interfaces to access the POSIX system services, but does not define the functionality of those services. Instead, the FORTRAN binding references the POSIX.1 standard for the functional definitions. The Ada binding to POSIX is also nearing completion. It is a "thick" binding in that it defines both the Ada interfaces and functionality. (I do not intend to devote a column to Ada in the future.)

There are advantages and disadvantages to each approach.

Because all the information required is contained in one document, thick bindings are easier to read. Furthermore, if one uses the thick approach, it is easier to map the functionality into native-language constructs. (The Ada-bindings group (P1003.5) has

done this, and been praised for producing a binding that is very Ada-like—I don't know whether this can be thought of as complimentary.)

Thin bindings are more conservative. Because functionality is not defined in thin binding, there is no opportunity for errors or inconsistencies to be introduced. Moreover, thin bindings are easier to adapt to changes in the base document. For example, the FORTRAN binding currently references the 1988 version of POSIX.1. But POSIX.1 has been updated (1990) with several changes to functionality. The .9 group determined that the FORTRAN binding requires only one substantive change to reference the 1990 standard as the base document.

Work To Be Done

There is still much work to be done. At the April meeting, .9 processed responses to the public ballot. The group received a wide range of opinions that were discussed in Santa Clara in July. If all goes well, there might be a proposed standard by December.

My bet is that it won't run on an IBM 704, the way FORTRAN I did. -->

Peter H. Salus is the executive director of the Sun User Group. He has attended both ISO and P1003/P1201 meetings and expects remission of time in purgatory as a result. Email: peter@sug.org.

P1003.9 Contacts

John McGroary (Chair)
Hewlett-Packard Co.
19447 Pruneridge Ave.
Cupertino, CA 95014
mcgroary%hpda@hplabs.hp.com
(408) 447-0265

E. Loren Buhle, Jr., Ph.D.
University of Pennsylvania
School of Medicine
3401 Walnut St., Rm 440A
Philadelphia, PA 19104
buhle@xrt.upenn.edu
(215) 622-3084

Joseph J. King, Ph.D.
Genetics Computer Group
575 Science Drive, Ste. B
Madison, WI 52711
JKing@GCG.Com
(608) 231-5200

IEEE-488 Instrument Control



Test and Measurement Monitoring and Control Laboratory Automation

SPARCstation Series

Your choice of two solutions

- Plug-in SBus board
 - IEEE-488.2 compatible
 - 1 Mbytes/sec (read and write)
 - Turbo488 ASIC for maximum software throughput
- External SCSI ↔ GPIB box
 - 64K RAM frees SCSI bus
 - Built-in DMA

Sun-3 and Sun-4

- VME labs certified plug-in boards
- Adapter brackets, cables
- SCSI/GPIB converter for Sun-3

Software

- High-speed NI-488M™ multi-tasking driver for all interfaces
- NI-488M programs compatible across platforms
- Interactive development and configuration utilities

Call for **FREE** Catalog
(512) 794-0100
(800) IEEE-488 (U.S. and Canada)

NATIONAL INSTRUMENTS®
The Software is the Instrument®
6504 Bridge Point Parkway
Austin, TX 78730-5039

JAPAN (03) 3788 1921 • UNITED KINGDOM (06) 35 523 545
FRANCE (1) 48 65 33 70 • GERMANY (089) 436 1447
ITALY (2) 4830 1892 • SWITZERLAND (056) 45 58 80

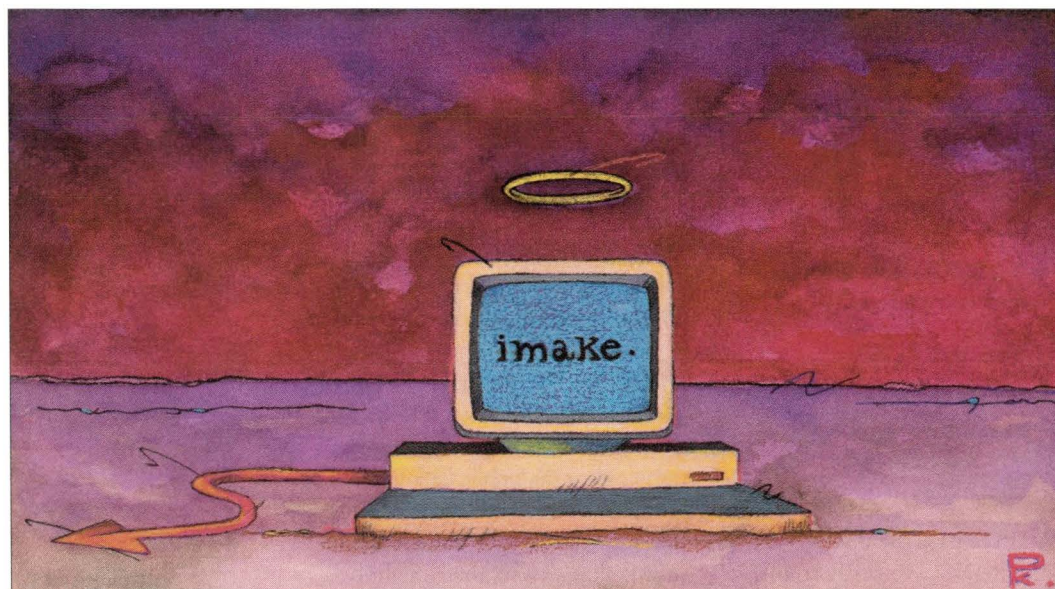

ILLUSTRATION BY PETER KALABOKIS

Imake: Friend or Foe?

by DINAH MCNUTT, Pencom Software Inc.

This month Miles O'Neal and I will provide a tutorial on `imake`—a useful tool for managing your Makefiles. If you have already encountered `imake` and have learned to despise and curse it, hopefully this column will help you better deal with its idiosyncracies.

Motivation

`make` (and variations of `make`) are valuable tools for compiling and installing software. `make` uses commands (usually stored in a file named `Makefile`) to determine which programs to compile, what to name the executables and where to install the software. Maintaining the `Makefiles` is usually pretty straightforward, as long as you have a small number of program directories and are only dealing with one computing environment.

However, what do you do when your vendor comes out with a new version of the operating system and you now need to maintain two versions of your software? Not only do you want to install the binaries in different locations, but

the `Makefiles` must all be modified in order to add a flag for the new C compiler. You could keep two copies of everything or get real creative with your `Makefiles` in order to solve this problem, but these solutions are awkward and difficult to maintain.

You can see where the problem becomes even more complex if you add different architectures, several hundred program modules and a few directory trees. The effort to maintain the software can become staggering.

A utility that addresses this problem, `imake` uses configuration files that define default values for variables like `c` compile flags and directory locations for software installation. If you need to change a compiler option, you only have to change one or two files instead of several hundred. All the `Makefiles` have standard targets like `all` and `install`, so compilation and installation procedures can now be the same for all systems.

So why should a system administrator care about this? If you are a typical SA, chances are you may be involved in the support of X and have to deal with `imake` on a daily basis.

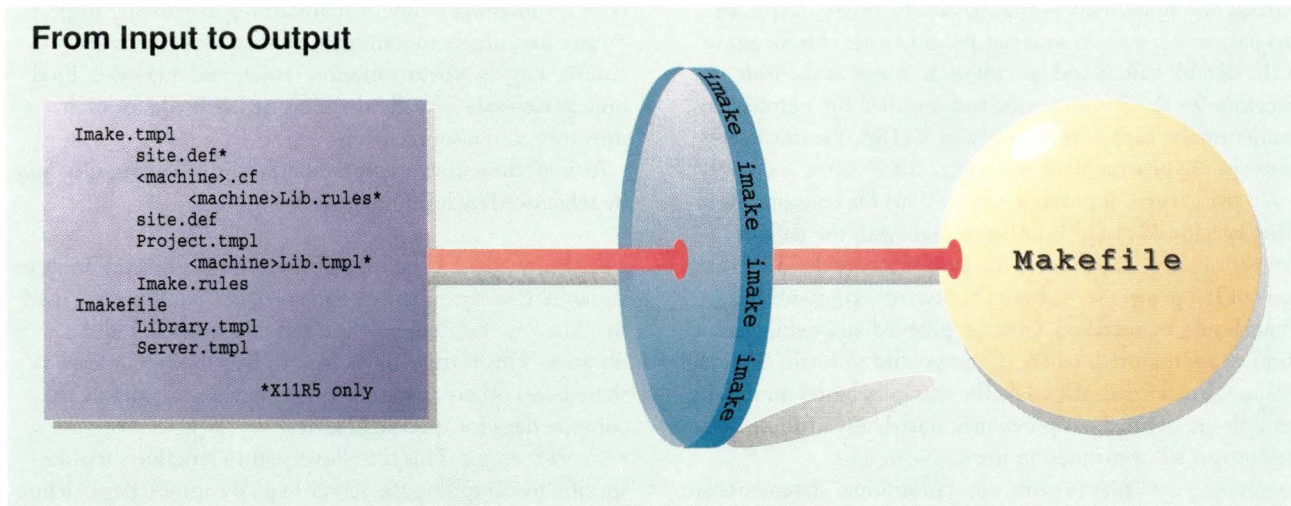

In addition, most SAs have a good understanding of what it means to deal with a collection of heterogeneous systems and may want to advocate the use of `imake` for supporting and maintaining local programs.

Imake

Developed at MIT as part of the X Window System project to address the problem of configuring X for different architectures, `imake` is included with the X11 source distribution and is provided as standard system software by several vendors. Software packages that use `imake` include programs that comprise the Project Athena distribution (`kerberos`, `zephyr`, et al.).

`imake` is short for “include make.” It uses the include-file and macro-processing capabilities of the `c` pre-processor, `cpp`, in order to generate Makefiles. Centralized configuration files are used to define the rules that govern how the Makefile is created with the capability to override pre-existing rules for special cases. The end result is a working Makefile.

In general, the process works as follows: You must create an `Imakefile` for each program or program directory. The `Imakefile` contains the `cpp` macro functions that indicate what program targets should be built. The script `xmkmf` is then used to bootstrap a Makefile using the `Imakefile` and centralized configuration files. `xmkmf` stands for X make Makefile and is located in `$TOP/util/scripts` where `$TOP` is the location of your X11 source tree. (Note, `xmkmf` is only available with X11R4 and X11R5. If you are still using X11R3, you will have to write your own version of `xmkmf`.) Finally, `makedepend` (another tool from the X Window development effort at MIT) is run to generate header file dependencies for C source code. Once you have a working Makefile, updates may be made by specifying the Makefile target that is common to all the Makefiles. Let’s look at this process more in depth starting with the configuration files.

How Imake Works

All of the central configuration files mentioned below (with the exception of the `Imakefile` that is located in the

same directory as the source code) are located in `$TOP/config`. `imake` processes the configuration files in the order shown in the figure above. The steps described below each result in a portion of the Makefile being created until the final result is a working Makefile.

`Imake.tpl` is the master template as indicated in the figure. It has several sections. The first section uses the `cpp` machine-specific trigger symbol to define the system-dependent configuration file. On Suns, the `cpp` trigger symbol is “sun” and the configuration file is `sun.cf`. You may ignore this part of the file unless you are adding support for a new system. The files described below are included in the `Imake.tpl` file via the `cpp` `#include` directives.

Therefore, the `site.def` file is processed next. Here, you can define variables specific for your site. The X11R5 version is divided into two parts. The first half contains the variables that should be defined before the `<machine>.cf` file is used. Any variables that the `<machine>.cf` needs should be defined in this section (such as whether or not you have the GNU C compiler.)

After processing the first half of `site.def`, `imake` then processes `<machine>.cf`. This file contains the platform-specific variable definitions such as:

- OS major and minor numbers,
- OS dependencies such as System V or BSD compatibility,
- whether or not the system supports Saber C,
- compiler flags,
- on Suns, whether or not you want to include SunView support.

The `sun.cf` includes support for all the Sun architectures including Sun 3s and 386i’s.

The `<machine>.cf` file includes `<machine>Lib.rules` (X11R5 only). This file contains the definitions for whether or not the system supports shared libraries and rules for creating libraries.

After processing `<machine>.cf`, `imake` returns to `site.def` and checks for the `cpp` symbols `BeforeVendorCF` and `AfterVendorCF` in order to determine which part of the file to execute. These symbols are

defined and undefined as appropriate in `Imake.tmpl`. In this part of `site.def`, you can provide overrides for some of the default values and specify such things as the root directory for the X source tree and installed file permissions. As mentioned earlier, this is only in X11R5. Previous versions simply process all of `site.def` after `<machine>.cf`.

`Project.tmpl` is processed next. This file contains everything specific to the project being managed; the default `Project.tmpl` is, of course, X. Symbols here define the parts of the project to be built, backwards compatibility, what should be installed, whether profiled and debugged libraries are required, where things go and so forth. After the symbols are defined, the Makefile variables based on these symbols are defined. As previously stated, any of these definitions can be overridden in the `site.def` or `<machine>.cf` files because `cpp` conditional statements are used to check if a variable has already been defined.

`Project.tmpl` includes `<machine>Lib.tmpl` (X11R5 only). (Actually, it includes `ShLibIncludesFile`, which is defined in `<machine>Lib.rules`.) This file contains the variables for building shared libraries.

`Imake.rules` is processed next and includes the macros (rules) to make all the targets, as well as the dependencies between the rules. These rules are not documented anywhere except within this file. The rules provided should be sufficient for most projects, but this is where you would add your own if required.

Now, the local Imakefile is processed. This step is the important part from the standpoint of someone developing

code or documentation or maintaining an existing project. Source and object modules are defined along with executable targets, documentation targets and any other final objects desired. (Usually there is one Imakefile for each directory in the source tree.)

As if all those files are not enough, the following files may be referenced by local Imakefiles:

- `Library.tmpl`: The Imakefile can define several Boolean variables (`DoNormalLib`, `DoSharedLib`, etc.) that are used by `Library.tmpl` to redefine variables used to build libraries. This feature allows you to build some libraries as shared and others as static without having to redefine the compile flags for specific libraries.
- `Server.tmpl`: This file allows you to redefine variables specific to compiling the server (e.g., `c` compile flags, debug flags, etc.).

Finally, rules common to all Makefiles are defined. These include subdirectory rules, notifications that installs are finished, etc. The `makedepend` program is run separately from `imake` (as one of the Makefile targets); it appends its output to the Makefile. The header dependencies generated by `makedepend`, if any, are the final statements in the Makefile.

In practice, you will usually only have to edit `<machine>.cf`, `site.def`, and the individual Imakefiles. The README file provided in the `$(TOP)/config` directory describes which variables are set in each of the configuration files.

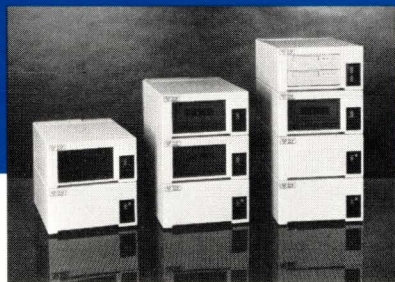

Storage Stak II Features

Patented Between Module Interconnect

- Built-in SCSI and Power Bus
- Solid-State Bus "Bars" Connect Modules

High Quality Power Supply

- Each Module Contains Ultra-Ranging High-Performance Power Supply

The Front Looks Great... But The Back Tells The Story.



HITACHI Disk Drives for Mass Storage

Unattended Backup

Clean, Simple Rear Box Design

- Universal Rear Doors Provide Base or Add-On Flexibility

Emissions and Safety Laws Adhered To FCC Class A, CSA, TUV Certified

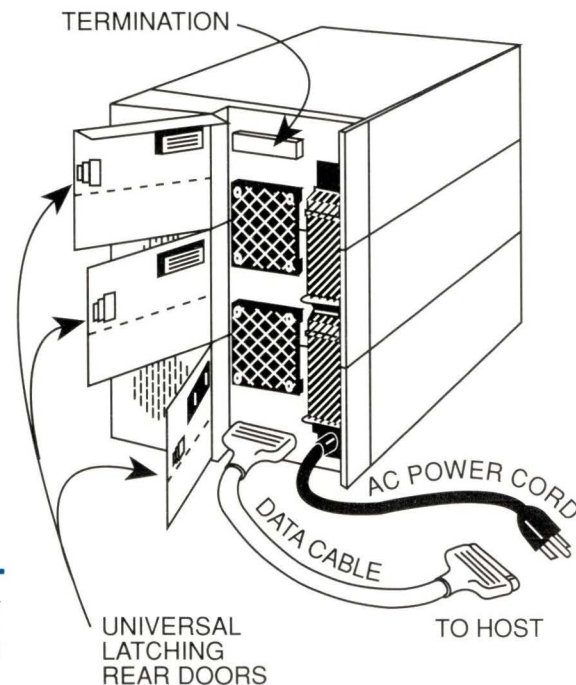

Specialized Systems Technology

P.O. Box 420489 • Houston, Texas 77242-0489
Fax: (713)781-8996 • 1(800)688-8993



REFLECTIONS OF QUALITY...

**1.65 GB in a 5.25-inch Form Factor.
Available Now Is the New Hitachi
DK516C-16 Winchester.**

To back-up the famous Hitachi quality, the DK516 series drives are offered with a 150,000 hour MTBF and a 5-year warranty.

Edge-to-Edge Performance

The DK516C-16 uses Hitachi's advanced proprietary technology to deliver 1.65 GB of capacity and a fast 13.5 ms average access time.

Its SCSI interface provides a maximum data transfer rate of 5.0 Mbytes/sec (synchronous), with a 256 Kbyte data buffer and read look-ahead cache.

Or, if you have an ESDI application, look into Hitachi's new 1.54 GB DK516-15 with a 14 ms average seek time and a 2.75 MB/sec data transfer rate.

Edge-to-Edge Quality

Choose the DK516 and you get a drive backed by the quality and reliability of Hitachi—a \$44 billion company. Unlike other drive manufacturers, we design, build, and test all key components in-house.

If your new system design is leading the edge, then there's only one disk drive choice: the new DK516, from Hitachi.

For more information about the DK516, or any Hitachi disk drive, call 1-800-HITACHI.

Hitachi America, Ltd.
Computer Division, MS500
Hitachi Plaza
2000 Sierra Point Parkway
Brisbane, CA 94005-1819



HITACHI®

Our Standards Set Standards

The Leading Edge of Capacity

CONSAN 612-949-0053
(IA, IL, IN, KS, KY, MI, MN, MO, ND,
NE, OH, Pittsburgh, PA, SD, WI)

GENTRY ASSOCIATES
800-877-2225 (AL, D.C., FL,
GA, LA, MD, MS, NC, SC, TN, VA)

R SQUARED 800-777-3478
(AZ, CA, CO, NM, OR, UT, WA, WY)

SIGNAL 800-228-8781
(CT, MA, ME, NH, RI, VT)

SPECIALIZED SYSTEMS
TECHNOLOGY 800-688-8993
(AR, LA, OK, TX)

Circle No. 21 on Inquiry Card

Writing Imakefiles

Many people avoid writing Imakefiles out of fear or ignorance. They are actually quite easy to create and maintain. The following examples should work with all standard MIT versions of Imake, except where noted.

An Imakefile for a program with only one source is simplicity itself. The following example shows an Imakefile for a simple maze program. It uses only one macro call:

```
SimpleProgramTarget (maze)
```

Running this through `imake` will produce a Makefile containing all the targets (`all`, `clean`, `install`, etc.) plus one for `maze`. An equivalent, clean, portable Makefile with a few minor system dependencies and the targets `all`, `clean` and `install` would typically run 30 to 50 lines.

A more complex program with multiple source files is almost as simple. The Imakefile shown below introduces two new variables to be defined, `SRCS` and `OBJS`, and uses a different macro.

```
DISABLE_ROOT = 1

SRCS=main.c maze.c scrnsaver.c password.c
OBJS=main.o maze.o scrnsaver.o password.o
SYSLAST_LIBRARIES = -lm
```

```
ComplexProgramTarget (maze)
```

This example also introduces the variable, `SYSLAST_LIBRARIES`, which defines the libraries needed at the end of the `ld` line in the Makefile. User variables may be defined for the source code as well as with `DISABLE_ROOT` in the preceding example.

Libraries may be built with similar ease. Here is an example that demonstrates building a simple library named `libmaze.a`. It shows how to use the library to build an executable.

```
LIBOBJS = maze.o scrnsaver.o password.o
NormalLibraryTarget (maze, $(LIBOBJS)
SRCS=main.c
OBJS=main.o
NormalProgramTarget (maze, $(SRCS), libmaze.a, , ,)
```

Versions of `imake` through X11R3 did not have `NormalProgramTarget()`. For these, `SingleProgramTarget()` should be used. The calling sequence is the same; however, no dependent library parameter—the third parameter—is included.

To test an Imakefile, run `xmkmf` in the directory in which the Imakefile resides. You can then run `make -n` against the new Makefile to check syntax, options and so on.

Many more targets are available. A complete list for any version of `imake` should be available in `$(TOP)/config/make.rules`. Some common types of targets to build include `lint` and profiled libraries, man page installs, and subdirectories.

Hints and Gotchas

Instead of writing Imakefiles from scratch, find one that is close to what you want and modify it. You can also copy a working Makefile from another directory on the same level of the source tree hierarchy and type `make Makefile` in order to create a Makefile from your Imakefile. This is usually easier than using `xmkmf`, but you have to “touch” your Imakefile if you copy the Makefile after you write the Imakefile.

Another hint: Initial scrutiny of the X11R5 config directory will uncover the following enhancements to the X11R5 `imake` process:

- Support for new hardware including Convex,
- The addition of new central configuration files: `<machine>Lib.rules`, `<machine>Lib.tmpl`,
- Extensive shared library support.

`imake` is not just for X and it is not just for source code. You can use `imake` to install shell scripts, for instance. One idea that comes to mind: use `imake` with other tools I’ve discussed in this column (`watcher`, `rdist`, `expect`, etc.) in order to distribute and install utilities for system administration. Because each system is a little different, you can write your own macros to handle exceptions and weirdness.

Acknowledgments

This was the most difficult column I’ve written so far. It would have been more difficult without the help of Miles O’Neal, fellow Penncommer. Miles claims to have been working with X forever: He can be reached at `meo@pen-com.com@cs.utexas.edu`.

References

1. DuBois, Paul, “Using Imake to Configure the X Window System, Version 11, Release 4,” unpublished paper dated 8/3/90
2. DuBois, Paul, “Using Imake for Multiple Projects (document version 1.02),” unpublished paper dated 7/24/90. (These are available via anonymous ftp from `indri.pri-mate.wisc.edu` in `~ftp/pub/imake-stuff`.)
3. Fulton, Jim, “Configuration Management in the X Window System.” This paper is found in `$(TOP)/doc/config/usenixws/paper.ms` in the X11R4 and R5 source distribution. ➔

Dinah McNutt is on the board of directors of the Sun User Group and is employed by Pencom Software Inc., a consulting and software-development company headquartered in Austin, TX. Her email address is `dinah@expert.com`.

A Little Help for Your Friends

If you know someone who should be receiving *SUNEXPERT Magazine*, please feel free to pass along a copy of the qualification card located elsewhere in this magazine.

The SPARCs are going to fly.



We put SoftBench on Sun. So you can put your CASE on autopilot.

SoftBench automates all those tedious, repetitive tasks in the software development process. This gives your developers more time to think and speeds up the project life cycle, while reducing errors and rework. And now it runs on



Sun SPARCstations, as well as HP and Apollo workstations.

A tool integration platform, with its own set of tools, SoftBench provides distributed computing services, tool communication, and a common user interface that's easy to learn and use. Add Encapsulator, and you can integrate your favorite CASE tools. Now and in the future. Without even having to change source code.



SoftBench will make your software development process far more efficient, cost-effective and accurate than ever before. It will protect your present and future hardware and software investments, too.

Call **1-800-637-7740, Ext. 2199** for complete product information. And get the best CASE environment under the Sun.



Circle No. 20 on Inquiry Card

© 1991 Hewlett-Packard Company CSSE001

Introducing the next generation of UNIX servers. And the next. And the next.

Everyone knows how fast technology is advancing, but this verges on the extreme:

Introducing the SPARCserver™ 600MP Series.

Today, they are the fastest, most expandable servers in Sun's history of fast, expandable servers. Tomorrow—literally—you can transform them from two-processor servers to four-processor servers.

And then, just when you've had time to catch your breath, you can step up their capabilities again with the soon-to-be-released Solaris™ 2.0 system software (based on UNIX® System V Release 4).

Each new SPARCserver system can be equipped with up to four processors for 90.3 SPEC throughput. That kind of blistering speed is just the ticket for faster file service, or blazing through the corporate databases (like Informix®, Ingres™, Oracle®, or Sybase®).

Unlike most multiprocessor servers—which force you to add entire system boards just to add CPUs—you can upgrade a SPARCserver simply by plugging in a small SPARC® module. It's faster, easier, and far cheaper.

And that's just one way to tailor these servers to your needs. A broad choice of memory, storage, and expansion options means you won't pay for more than you want. Or get less than you need.

Besides running the 3600 applications written for the Sun platform, our new SPARCservers will upgrade easily to Solaris 2.0—a symmetric multiprocessing environment. And it'll be just as easy to upgrade to the next generation of SPARC chip when it comes along—just plug in a new SPARC module.

So now that server technology has taken three steps forward, perhaps you should take a step toward the phone. Just call us at (800) 426-5321 ext. 300, and we'll rush you more information about the new SPARCserver 600MP Series.

They're going fast. And faster. And soon, even faster.



*SunSoft, Inc.'s Solaris 2.0 is scheduled for release in the first half of 1992.

© 1991 Sun Microsystems, Inc. Sun Microsystems and the Sun logo are registered trademarks of Sun Microsystems, Inc. Solaris is a trademark of Sun Microsystems, Inc., licensed to SunSoft, Inc. SPARC is a registered trademark of SPARC International, Inc. SPARCserver is a trademark of SPARC International, Inc., licensed exclusively to Sun Microsystems, Inc. Products bearing the SPARC trademark are based on an architecture developed by Sun Microsystems, Inc. UNIX is a registered trademark of UNIX System Laboratories, Inc. Informix is a registered trademark of Informix Software, Inc. Ingres is a trademark of Ingres Corp. Oracle is a registered trademark of Oracle Corp. Sybase is a registered trademark of Sybase, Inc.



Today

This is Sun's fastest, most expandable family of servers ever—the new SPARCserver 600MP Series. Performance you'd expect from a multiprocessor server, at prices you'd expect from Sun.

Tomorrow

For heavier workloads and more users, plug in this SPARC module and you've upgraded from two CPUs to four. Because you don't buy an entire system board, you don't spend a fortune.

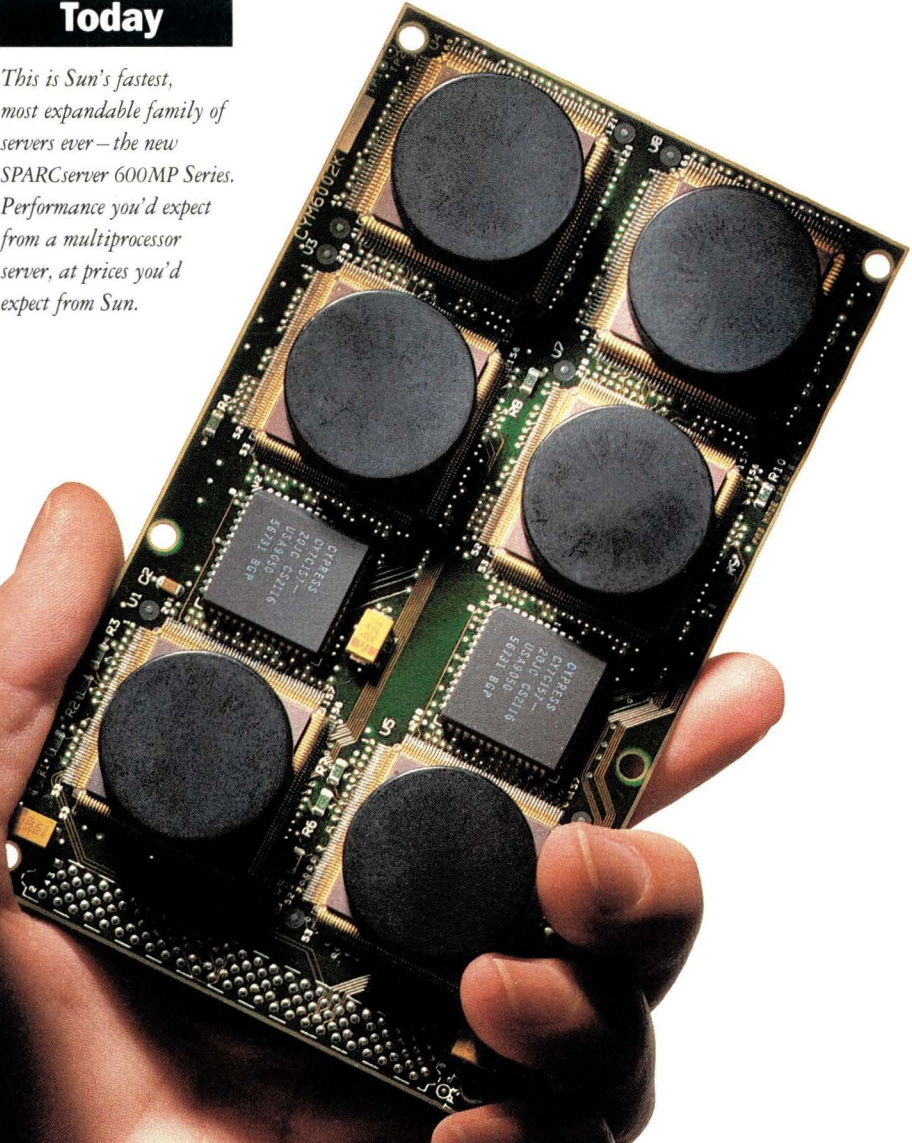

Soon

*The next generation of UNIX servers will yield even more powerful capabilities with the arrival of the next generation of client-server system software.**



GRAPHICS

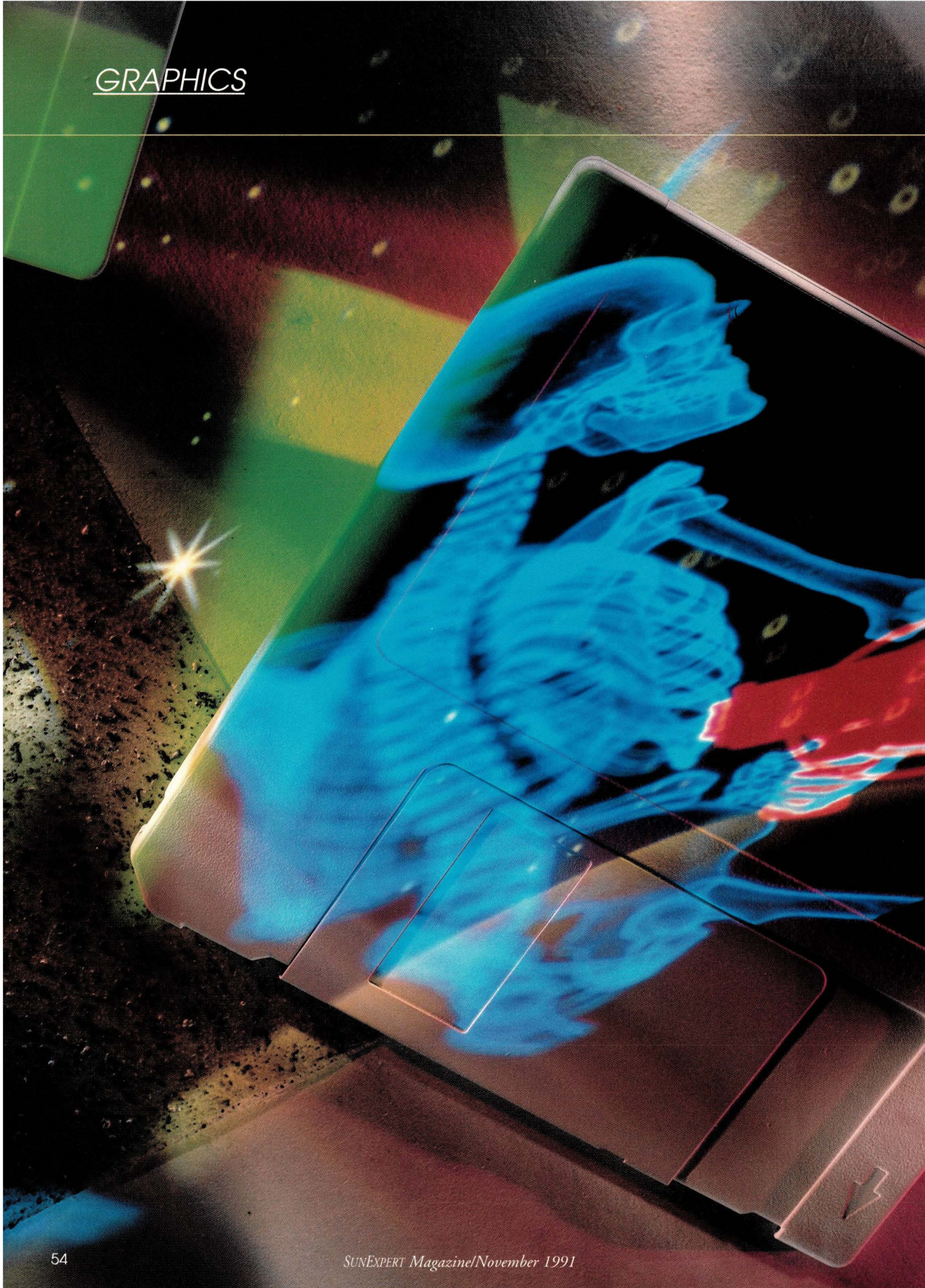

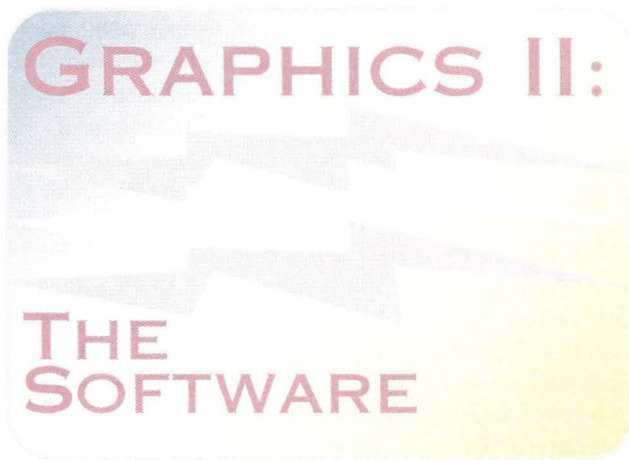

No where was the essentially ambivalent relationship between Sun Microsystems Inc. and graphics revealed more clearly than at this year's Siggraph. The 1991 keynote speaker at that preeminent graphics show, which manages to somehow combine the flavor of Comdex with that of the Cannes Film Festival, was none other than Sun's CEO, Scott McNealy.

In his speech, McNealy made reference to the fact that high-end graphics had been the making of his company. It was, he recalled, at exactly such a graphics show that a very young, very small Sun had been identified as the machine to which Pixar rendering machines were being attached, and with which the special effects of Star Wars were being done. Instantly, the company's booth had been filled with customers. "Now," said McNealy, "we send 150 employees to make sure that the booth's packed at all times."

But, in the same speech, McNealy also made it clear that he came not in homage. His audience was filled with graphics gurus, to whom his company owed much, yet he made it clear that high-end graphics remain only a passing interest for Sun. "There is always a trade off between what is fun and what is useful," he said. And the very-high-end graphics that otherwise dominated the show—the liquid-metal android of Industrial Light and Magic, the virtual-reality exhibits at the back of the hall, the strange and wondrous art forms of the electronic theater—these did not seem to rate high on his list of the useful.

Suns are not supposed to be graphics boxes. Yet, they are increasingly a favorite of graphics ISVs.

by MICHAEL JAY TUCKER,
Executive Editor

Indeed, said McNealy, in the age-old confrontation between art and commerce, maybe computer graphics should really focus on the latter. "I think it is fun to hang out in a lab and invent something," said the Harvard Business School-educated McNealy to the computer scientists of the room, "but I think it is a total blast to have a channel of distribution and a customer base that wants to use it."

Yet, if he said things that seemed—at first blush—absolutely antithetical to the fundamental beliefs of his audience, then so, too, did he present them with a vision—an inexpensive, standardized platform most of them

could afford, and for which all of the software developers among them could write in relative safety.

'I'm Bah-ack'

The unquestioned champion for high-end graphics among workstations is Silicon Graphics Inc. It is the company that, more than any other, realized the promise that Sun seemed to make back with Star Wars. Not only are the company's workstations used in virtually every application where very-high-end 3D graphics are a requirement, but also its Graphics Library—GL—has become effectively the standard for graphics applications. When IBM Corp.

debuted its RISC System/6000, for example, it did so with GL as a licensed part of the product.

Moreover, GL is at the heart of many vendors' offerings. Graphics-technology analyst Ron Roncarelli, publisher of *Pixel* newsletter, identifies the top names in the very-high-end graphics software as "Alias Research Inc., Wavefront Technologies, Soft-Image Inc. and Thomson Digital Image Inc. (TDI)." Of these, only Wavefront is on Suns.

There is only the remotest of possibilities that the other three will ever make that transition. "We depend on SGI," explains J. Peter Goldie, mar-

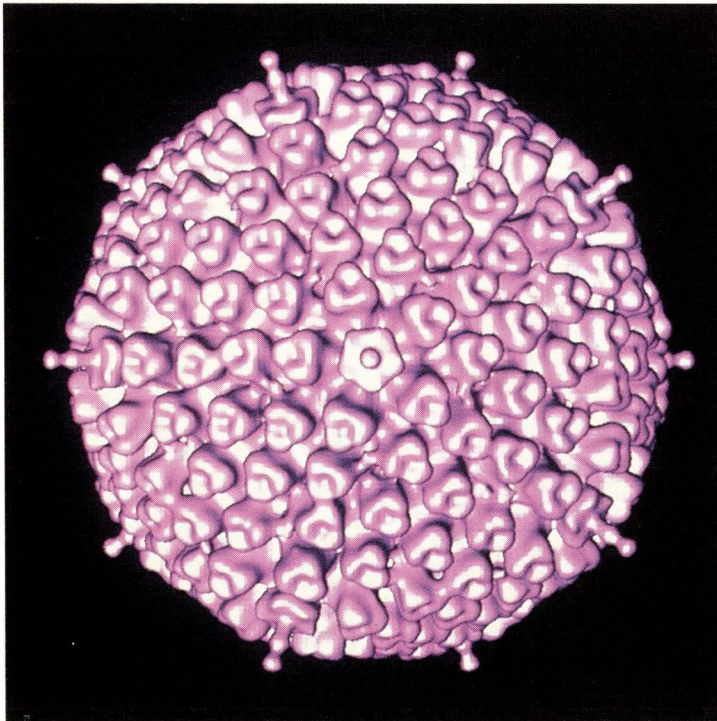

Courtesy of The Wistar Institute

Visualizing A Killer

One user of Stardent Computer Inc.'s AVS is Phoebe Stewart, a post-doctoral fellow (supported by the Helen Hay Whitney Foundation) at the Wistar Institute of Philadelphia. She is involved with a visualization effort headed by Professor Roger Burnett, with collaborators Stephen Fuller and Marek Cyrkaff of the European Molecular Biology Laboratories, Heidelberg, Germany, to visualize the Adenovirus. "It isn't the most deadly virus in the world," she notes, "but it is very large and complex."

But, she explains, there is deadly and there is deadly. While the virus itself isn't a vicious brute on the level of, for example, AIDS or plague, it can still be a killer. It causes conjunctivitis and dysentery. In developed countries, such things are only mild diseases. In the Third World, though, where clear water may not be readily available, the virus can cause death by dehydration. In fact, it is a leading cause of death among children in the Third World.

Thus, there is real motivation to find drugs that could control the disease. To this end, Stewart's group is visualizing the virus with AVS. "It turns out that the virus is held together by a relatively small number of cementing components," she says. "And those may be ideal targets for an antiviral drug."



keting director for Alias. "We've always been on SGI. No one else had the graphics performance." And, no one else had GL, at least not until now. "We're tied into GL," he notes. "When IBM introduced the RS/6000, it was easy for us to port to it."

Yet, those who have Suns but want GL don't have to abandon all hope. GL has recently been made available for license...though it isn't yet on SPARC. Moreover, GL emulations exist. One of these is PX/GL from Du Pont Pixel Systems. It does not currently run on the SPARC processor itself, but rather on Du Pont's own i860-based graphics boards for Sun workstations. However, company officials hint that the product could migrate to the SPARC, if there were sufficient incentive to do so.

In addition, Sun has itself recently introduced XGL, which the company says brings to its X-based environments a GL-style of programming.

Wavefront Technologies is the only member of the Graphics Gang Of Four to run on Sun Microsystems Inc. equipment. The image, "Clockscape," was created with Wavefront graphics software and data supplied by Seiko, the famed maker of time pieces.

Beyond GL, there is Wavefront, the only member of the high-end Graphics Gang of Four to port directly to Suns. The company did so not because of any particular admiration for Sun's technology, but because it recognized there was a vast population of Suns out there whose users might wish to do graphics. "It is important," explains the company's vice president of market development, Ian Reid, "to make our products available on the platforms the

customers actually have." In particular, the company is promoting its scientific-visualization products on the Sun.

Another big-name graphics company that Sun users can consider is Intelligent Light Inc., which offers a suite of several visualization and rendering products. The company differs from the Big Four in that it tends to focus on scientific, technical and engineering applications. At this year's Siggraph, Intelligent Light stressed its products' ease of use, as well as their power and functionality.

Then, there's Pixar, the company whose very name is in some ways synonymous with high-end graphics. It was Pixar that first put Suns in the graphics business when it built its Pixar Image Computer processors to run off them. Later, Pixar had sold its hardware business to Vicom Systems Inc. and today divides its time between producing computer animation for the commercial and enter-

tainment industry, and providing software and software services to the computer industry.

Among other things, Pixar has spent the last few years promoting the RenderMan interface, a comprehensive 3D scene-description specification. This defines the way that software should describe objects, lights, scenes, etc. It allows a RenderMan-compliant package running on one

machine to write files that can be read and rendered by a RenderMan-compliant package on another machine.

Several companies, including Sun, have embraced the interface. Moreover, Pixar sells a RenderMan Toolkit—software for OEMs that wish to incorporate RenderMan-compliant functionality in their own products. “What we have, basically, is a toolkit for developers who want to use the

interface. It is a sales tool for an OEM relationship,” explains M.W. Mantle, Pixar’s director of 3D graphics.

Thus, Sun users can get RenderMan code from such companies as Autodesk Inc., which uses the product. However, Pixar is more than just a technology supplier to ISVs. At least some sophisticated end users are buying the RenderMan Toolkit and using it on Suns straight out of the box. “We’re finding

Just Imagine Imaging

Sun Microsystems Inc.’s CEO and president, Scott McNealy, began his Siggraph '91 keynote address with a videotape parodying himself. At the beginning of the tape, McNealy is shown at golf. He scores an improbable hole-in-one thanks to an image-processing application that causes the ball to zoom into the cup with the deadly accuracy of a cruise missile.

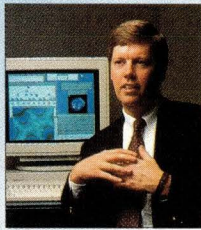

The tape was purportedly comic, but McNealy’s, and by extension, Sun’s, interest in imaging and image processing—at the expense of graphics—was evident throughout this year’s Siggraph. In his talk, McNealy said bluntly, “In the past, we’ve spent on graphics. In the future, though, perhaps we will spend more on imaging.”

And, given Sun’s market direction and focus, that actually makes sense. Imaging tends to be the business of pattern recognition. As a very rough rule, imagers are interested in taking pictures and then making sense of them afterwards. Typical applications range from machine vision to military intelligence.

Some companies are offering software-only solutions—such as Paragon Imaging Inc. Paragon products include the Visualization Workbench, image-analysis software for Sun and other UNIX workstations. Traditionally, though, imaging is done with specialized hardware.

Among imaging hardware vendors is Datacube Inc., which offers among other things the MaxVideo 20. “This is an off-the-shelf image-processing solution,” says Susan Snell Solomon, director of the university program at Datacube. “It is a two-slot, 9U VME image-processing board...a real-time, 60-frame-per-second video digitizer and display.” It can link to SBus system via a connector.

Yet another board maker is Imaging Technology

Inc., whose product line is made up of some 15 VME boards. Typical of these is the VSI-150/151 Variable-Scan Interface. This board is made up of a camera interface to digitize images from standard cameras and a display controller. It, too, can link to SBus systems via a connector.

For those uninterested in a board-level solution, there are several add-on image processors on the market. Visual Information Technologies Inc. (VITec), for example, offers a PICAbbox, an enclosure that houses the company’s image-processing boards separately from the user’s system. The PICAbbox-50, for example, fits under a SPARCstation.

In addition, VITec has recently introduced the VXA raster accelerator, a single-slot SBus card that provides a SPARCstation or SPARClike with 24-bit true-color display, an 8-bit pseudocolor display, eight configurable overlay tag bits, two lookup tables, and double and triple buffering of pseudocolor windows. The product thus has applications in graphics, imaging and video.

Another imaging vendor is Vicom Systems Inc. Vicom, which says it is the largest independent supplier of imaging hardware, recently introduced the Master Image Data Server. This is a tower-configured system based on Sun’s own GX/MVX i860-based products.

Vicom has essentially remade itself over the last year. The company offers a number of different products from a number of different sources. When Pixar, for instance, decided to get out of the hardware business, it was Vicom that picked up the Pixar image-processing hardware line. Today, though, the company is attempting to gradually focus its efforts on the i860-based product line, and on its relationship with Sun. The two companies seem to be becoming very close indeed.

Meanwhile, Ramtek Corp. offers a SPARC-based imaging workstation, the Millennium. It is, in effect, a vertical SPARClike devoted to image-processing applications.

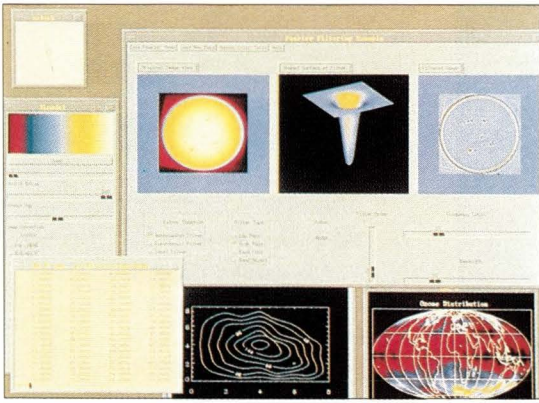

Scientific visualization may be the most active field for Sun Microsystems Inc. in graphics. Products include IDL (above) from Research Systems Inc.

that people are buying it...for their own rendering," says Mantle.

The Vast Middle

Software such as that from Alias and TDI is at the very top of what can be done with graphics on computers. However, this does not necessarily mean they represent the broadest possible market. Rather, their users tend to be an elite group. Individually, the purchasing power of such people can be staggering, but as a group, it is rather tiny relative to everyone else. "There is a tremendous market [for graphics] out there," asserts market analyst Roncarelli. "But it is not at the high-end. It is in the middle."

And, in fact, for Suns and SPARC-like, there is already considerable activity at the low-end—at what might be called the level of personal graphics. While ISVs still favor PCs and Apple Computer Inc. Macintoshes, and even Commodore Amigas, for such software, workstations are beginning to catch up. For instance, Island Graphics Corp. has marketed for some time a suite of products—IslandDraw, Write, and Paint—that gives UNIX systems capabilities like those of Mac and Windows-based systems. "We are not trying to be the Quark [Inc.] Xpress of workstations," explains David Newman, Island Graphics' marketing manager. "Rather, we are going to people

who are bringing graphics into an existing situation." In other words, the customers already have workstations, and now long to bring some sort of graphics functionality to an existing application. In addition, Corel Systems Corp. announced in September that it is shipping its CorelDRAW program for Sun under Motif. CorelDRAW is an illustration program formerly confined to PCs.

Ficor Inc., meanwhile, offers AutoGraph, a graphics package consisting of a charting program, a drawing program and SlideShow, a display facility. Other graphics products are supposed to be coming soon. Computer Support Corp. says that it will shortly be porting its PC-based composition and

drawing package to Suns. It already sells a clip-art package for Suns, as does T/Maker Research Co., whose ClickArt Volume contains some 1,000 images.

But, in general, the products showing up now tend not to be graphics products per se; rather they are applications with some aspects of graphics to them. With the exception of CAD/CAM and other design-oriented applications, a field so broad that it requires quite a separate article, the graphics products coming on line for Sun are now frequently vertical applications—geographical information systems, imaging applications, desktop-publishing packages and so on.

Of all these vertical markets other than CAD, the one with the most potential for growth may be business-oriented graphics. Already, companies as diverse as Applix Inc., Informix Software Inc. and Clarity Software Inc., provide various charting and plotting facilities.

But, at the moment, the leading

“ If you’re looking for a scientific computing and visualization environment, you owe it to yourself to check out IDL.”

*Hal Elgie
Scientific Visualization Consultant*

Call us at **(303) 786-9900** or FAX **(303) 786-9909**
for a free IDL demo kit

RSI RESEARCH SYSTEMS, INC.
777 29th Street, Suite 302, Boulder, Colo. 80303

IDL: The only complete integrated environment for scientific computing and visualization on popular UNIX and VMS workstations.

Circle No. 36 on Inquiry Card

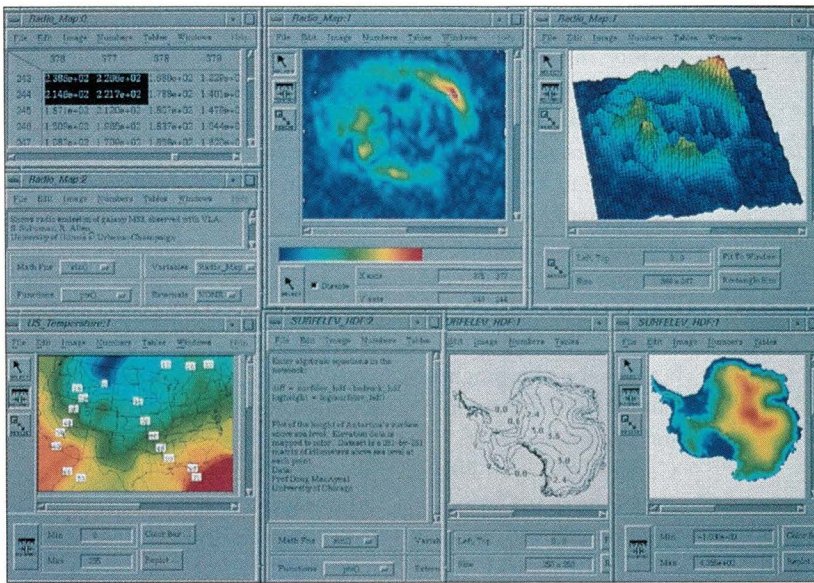

Companies with university connections promise to be a source of very cost-effective scientific-visualization software. Spyglass Inc., for example, says that its products are meant for visualization on a budget.

graphics market for Suns seems to be visual data analysis. For example, Precision Visuals Inc.'s products include PV-Wave, a suite of several different software packages for "reading, displaying, reducing, analyzing and re-displaying large...datasets." PV-Wave is a quick and reasonably easy way to tabulate data into readable charts. It isn't going to compete

any time soon with high-end animation packages, but PVI doesn't care. "For every one of the high-end guys, there are 10 or 12 at the low end," explains Brian Ritchie, PVI's vice president of marketing. In fact, right now, he sees his company's future in the application of PV-Wave to business graphics—that is, to the business professional who must quickly inter-

pret large amounts of data.

PVI's approach to the market has been to offer scientific visualization with an absolute minimum of fuss. In effect, it is scientific visualization for scientists who don't wish to program. A company with which PVI has some connection, but which has taken quite a different approach is Research Systems Inc. RSI's product is IDL, a

Solve the Electronic Publishing Puzzle with a few pieces from EOS.

EOS
VALUE
ADDED
RESELLER

The future of electronic publishing will require powerful workstation platforms and will embrace all manner of input, output, and processing tools. EOS has the pieces of this complex puzzle, and can offer a solution to fit your needs today.

When our engineers claimed their SPARC 470/490 memory was better than Sun's, we told them to prove it.

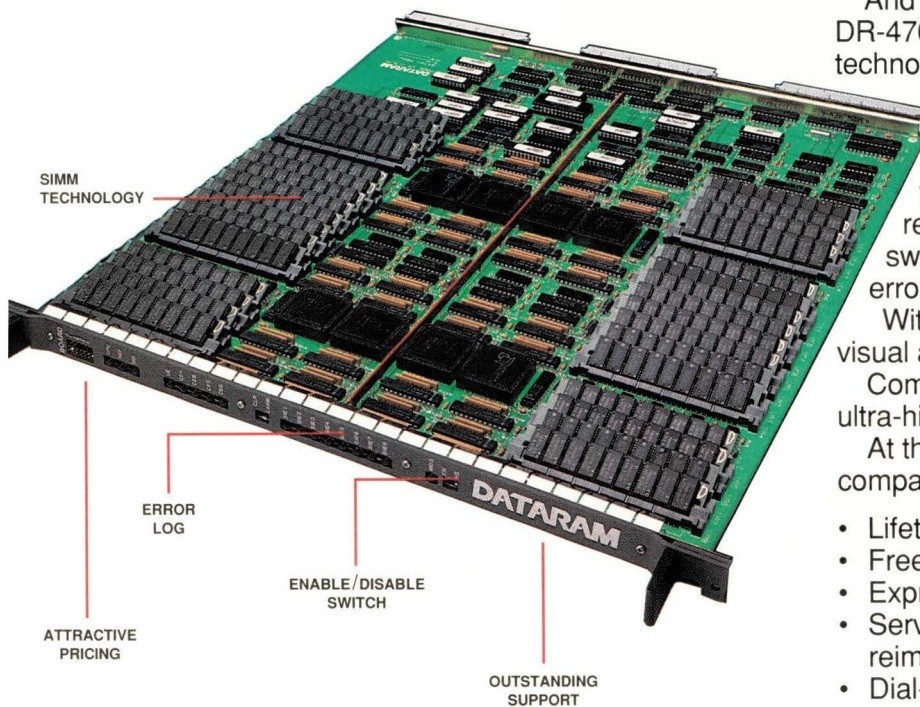

Better than Sun five ways to one. Dataram's memory for the SPARC 470/490 gives you everything you get from Sun.

And more. We offer 32MB and 128MB DR-470 boards based on SIMM technology.

Which makes them easy to maintain and upgrade.

Our easy-to-use error log lets you track errors down to an easily replaceable SIMM. The enable/disable switch helps you uncover system errors.

With LED indicators to provide quick visual alarm.

Complete expandability combined with ultra-high speed.

At the right price. Right now. Fully Sun-compatible, and backed by:

- Lifetime guarantee
- Free trial period
- Express spares
- Service-call expense reimbursement
- Dial-in assistance
- Trade in/up
- Technical support

Call **1-800-822-0071** if you'd like to know more about our innovative DR-470 or memory we make for all the other Sun workstations and servers.

Only from Dataram, the best name—and values—in memory. And winner of the 1990 *SUN OBSERVER* Excellence Award for Sun memory.

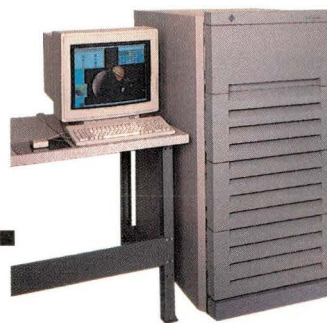

They **proved** it.

"See us at Sun User Group Booth #809-11."

DATARAM

All names referenced are trademarks of their respective manufacturer.

P.O. Box 7528, Princeton, NJ 08543-7528

Circle No. 50 on Inquiry Card

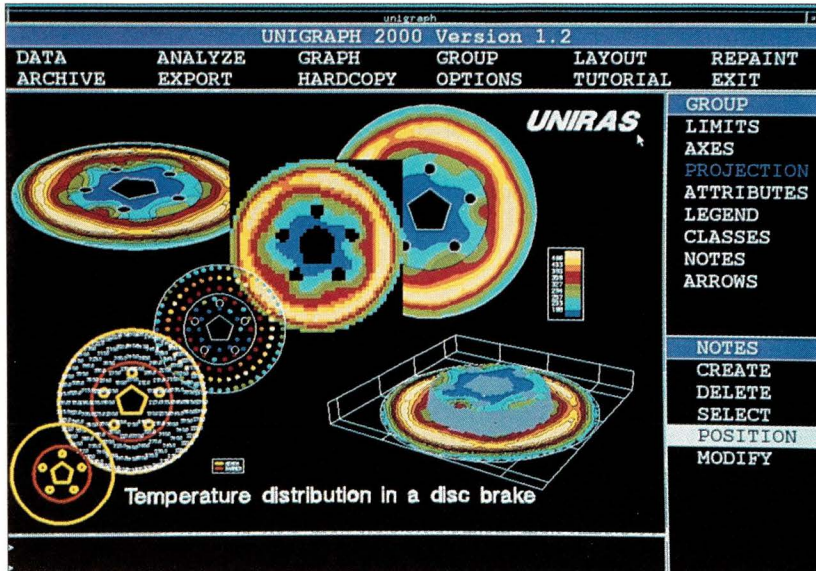

Unigraph+2000, from Uniras Inc., blends numerical analysis with data visualization. Here, an engineering application shows temperature distribution on disk brakes.

graphical environment for the rapid analysis and display of data.

RSI says that it supplied some of the source code that went into PVI's original products. Now, however, there is no connection between the two companies on their products. Where PVI stresses the ease of use of its products, RSI promotes its products on power and programmability. IDL users range from NASA to Oak Ridge National Laboratories.

Several other vendors have recently gotten into the field, sometimes by design, and sometimes almost by accident. Stardent Computer Inc., for instance, markets its own line of visualization-oriented workstations and servers. As part of its sales efforts, it developed the advanced visualization system (AVS). This was an easy-to-use scientific-visualization package, somewhat like PV-Wave. Rather to the company's surprise, AVS proved popular. Stardent ported the software to a variety of systems—including Suns—and is now selling it (see "Visualizing a Killer").

XRT/graph™ Widget

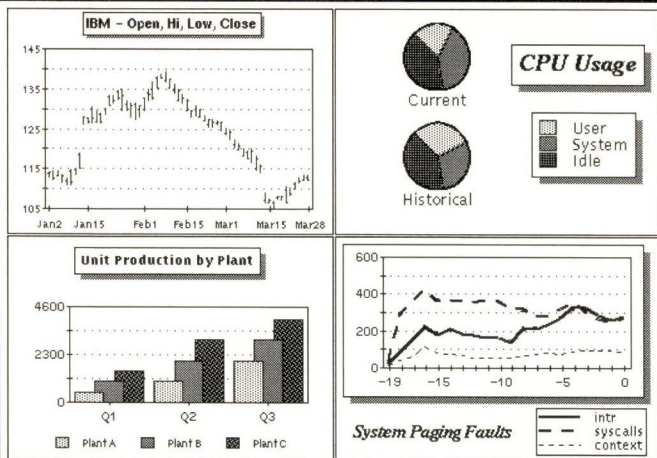

An easy, inexpensive way to add real-time plots, bar charts and pie charts to your X applications. The XRT/graph widget extends the XView, Motif and OLIT toolkits. XRT/graph is loaded with features, including user-feedback, markers and printing support.

And XRT/graph comes with the *Builder* point-n-click widget development tool. Builder saves graph descriptions in text files, and generates application code automatically.

- ✓ VERY FAST
- ✓ EASY TO USE
- ✓ FULL COLOR SUPPORT
- ✓ NO RUN-TIME FEES

XView version is available today. Motif available 11/91. OLIT available 12/91. XRT/graph is a trademark of KL Group Inc. XView is a trademark of Sun Microsystems, Inc. Motif is a trademark of OSF, Inc.

KL Group Inc. (416) 594-1026
sun.com ! suncan ! klg ! xrt_info

Circle No. 26 on Inquiry Card

F E A T U R E S
R E V I E W S
M A R K E T S
O V E R V I E W S
N E W S
U S E R P R O F I L E S
C O L U M N S
N E W P R O D U C T S

SunExpert serves the specialized market of Sun Microsystems Inc. workstations, compatibles, third-party enhancements and interoperable products. It is the authoritative source for the Sun user.

SUNEXPERT
Magazine

The Big Picture Just Got Bigger!

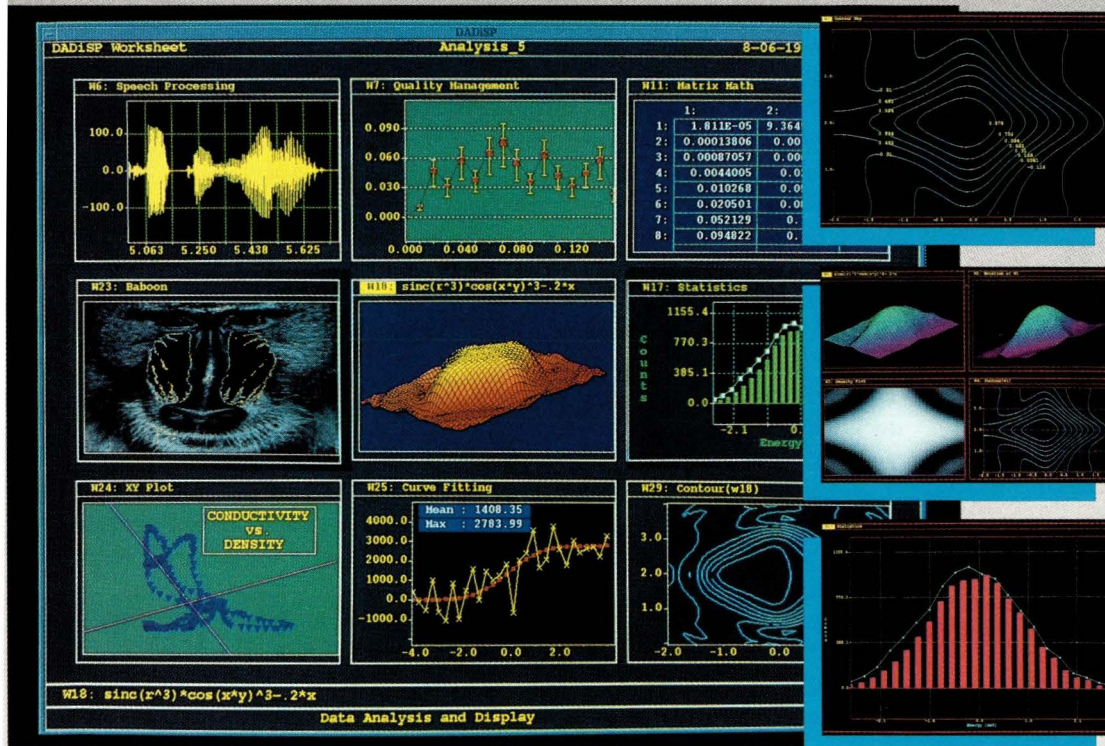

Matrix Processing

Inverse/Transpose
Eigen Values & Vectors
Matrix Math
2D FFTs and convolutions
3D and 4D Graphic Displays
Operations Research

Image Processing

Medical Imaging
Satellite
Seismology
Terrain Rendering
Communications

Lab Automation

Data Acquisition
IEEE-488
Test & Measurement
Process Control
Quality Improvement
Manufacturing Test

DADiSP 3.0

The Standard Worldwide —
adopted by thousands of
scientists and engineers for data analysis
and graphics.



Just Point-and-Click...

DADiSP works the way you do — from input to output. DADiSP's point-and-click menus put you in control: from Data Collection, Reduction and Management, through Visual Data Analysis and Hypothesis Testing, on to final output with DADiSP's outstanding Presentation Quality Graphics.

DADiSP automatically builds a permanent and reusable worksheet as you work. Organize your data, methods and graphs in DADiSP worksheets — for future reference and future projects — you can even create your own macros and custom menus.

Run powerful add-in modules right from DADiSP menus — talk to your lab instruments with the DADiSP/488 driver, use DADiSP/LT for Data Acquisition, and run your own favorite programs right from DADiSP.

Science

Statistics
Experimental Design
Hypothesis Testing
Peak Analysis
Chemistry
Medical Research
Quality Management

Engineering

Signal Processing & FFTs
Filter Design
Speech / Communications
Sonar & Radar
Electronics Design
Mechanical Test
Vibration Analysis

and more . . .

CALL 1-800-424-3131

for your free DADiSP trial disk. DADiSP is available now for your SUN, HP, IBM, NeXT, DEC, Concurrent and other workstation families, and of course, your IBM PC compatible.



Australia-Interworld Electronics, 03-563-7066; Belgium-Electronique-Mesures, (02)-384-7309; Denmark-Engberg Power Consult, 42-25-1777; England-Adept Scientific, (0462) 480055; Finland-Mespek OY, 9-0-3511800; France-SM2i, 01-34-89-78-78; Germany-Datalog, (02166) 9520-0; Digi-Logger, (07720) 38022; Informatik Systeme, 0631-34111-0; Ingenieurburo Kohler-069-769829; Kontron Messtechnik, 08165-770; India-Dynalog Microsystems, 22-517-0514; Italy-BPS Computers, 2-61290221; BRM Italiana, 771-0010; Japan-Astrodesign, 044-751-1011; Netherlands-Computer Engineering Roosendaal, 01650-57417; New Zealand-GTS Engineering, 09-392-464; Scotland-Diagnostic Instruments, 0501-43031; Sweden-Systec, 013-110140; Switzerland-Urech & Harr AG, 061-611325; Taiwan-Advantech, 2-351-2117; Howching (02) 5050525

DSP Development Corporation, One Kendall Square, Cambridge, MA 02139, 617-577-1133, FAX: 617-577-8211

Despite recent upgrades, Sun workstations remain middle-of-the-road graphics boxes.

Meanwhile, what could be particularly cost-effective sci-viz products are coming from the universities and research establishments. Over the last few years, academics developed a variety of scientific-visualization packages as a by-product of their research. Now, several of those are coming to the commercial market. The Ohio Supercomputer Center, for instance, developed a visualization package known as apE. At Siggraph '91, TaraVisual Corp. announced that it had come into business expressly to commercialize apE.

Another product with a university background, though one not yet on Suns, is Spyglass Transform from Spyglass Inc. Like PV-Wave, the Spyglass products provide inexpensive, easy-to-use visualization to researchers who don't wish to program. "Basically, our goal is to be the MacWrite of visualization," says Brad Fortner, the company's director of research and development. The Spyglass products are on SGI workstations and Macs; however products for Suns are said to be on the horizon.

Meanwhile, graphically oriented software for Suns is showing up in numerical processing and analysis, as well. Mathematica, from Wolfram Research Inc., is arguably the most

widely used software package for technical computation on PCs and workstations. In its more recent incarnations, Mathematica has consistently added more and more graphics functions.

Statistical Sciences Inc., meanwhile, offers S-Plus, an interactive programming environment for data analysis and graphics—with a particular focus on statistics.

A new entry into the numerical-processing business is Uniras Inc., with its Unigraph 2000 and agX/Toolmaster, both programming tools for numerical data visualization and analysis in the X Window System environment. The company says that its products are geared toward engineering and scientific applications.

And finally, Sun itself has—if not exactly product—then a means to products. It has SunVision, a "software platform" for ISVs and some end users. This is a set of visualization functions that can be incorporated in applications aimed at such markets as image processing, volumetric data display, 3D interactive graphics and rendering.

Several vendors are also offering developer's tools with a graphics orientation. KL Group Inc., for instance, sells XRT/Graph, a charting and plotting library for XView developers. KL says that the product is the first commercial XView extension of the market.

The UnFun Stuff

There are, of course, other players and other markets in Sun graphics. In fact, you would be hard pressed to find a vertical application on a Sun—ranging from geographical information systems to preprocess to digital signal processing (DSP)—that

isn't incorporating more and more graphics with every passing revision. But, suffice to say that Sun workstations are seeing a bit of a boom when it comes to graphics software. Not a big one, perhaps, but still a boom-lette all the same.

And that's odd. Despite recent upgrades in their graphics performance, Sun workstations remain middle-of-the-road graphics boxes. And, McNealy's comments at Siggraph suggest they're going to stay that way for, essentially, ever.

But, that may be the very reason for their success. Consider the IBM PC. The PC, and its successors, were always little more than ASCII terminals with a local CPU. For graphics tasks they were and still are far inferior to, say, the Commodore Amiga, or even the Mac. Yet, because it was so generic, so unspecialized, so...in other words...standard, it could be almost infinitely modified by third parties. Thus it is today that the PC is easily on par with the Macs and Amigas of the world in graphics tasks—because of, rather than in spite of, its limitations.

That, clearly, is what Sun hopes will now happen with its workstations. The machines will never be optimized for graphics or any other application. Sun will always provide just the minimum in graphics power that its buyers can tolerate. Then, someone else, third parties, can provide the special powers, in hardware and software, that go beyond that bare minimum—and everyone, Sun included, will benefit. At least that is the strategy, and neither Sun nor Scott McNealy seem to have any doubts at all about it. "We just have to be able to have the discipline not to go off and do the fun stuff," says McNealy. ➔

Reprints of *SUNEXPERT* articles are available on a custom printing basis at reasonable prices in quantities of 500 or more. For an exact quote, contact your local sales representative or *SUNEXPERT Magazine*, 1330 Beacon St., Brookline, MA 02146.

RESOLUTION REVOLUTION. RASTERFLEX™. SIMULTANEOUS 8 AND 24 BIT WINDOWS.

VITec's new RasterFLEX™ series of raster accelerators advances the revolution in true-color processing.

RasterFLEX-32™ brings unprecedented capability to desktop Sun SPARCstations™ and SPARC®-compatible workstations.

RasterFLEX-32 offers flexibility to drive simultaneous manipulation and display of true-color (24 bits-per-pixel) and grayscale/pseudocolor (8-bits-per-pixel) windows.

Graphics and photographs can be merged, allowing non-destructive graphic overlays on top of true-color images.

RasterFLEX-32 provides accelerated performance packed on a single Sbus card that is loaded with Open Windows™ and X Window System™(V11R4) software environments for plug-and-play performance.

Call us and join the true-color revolution. Also ask about the RasterFLEX-8™ and RasterFLEX-HR™ high resolution products.

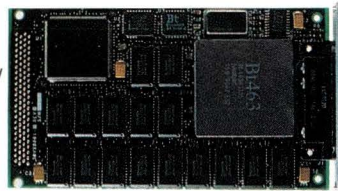

THE RASTERFLEX-32 CARD.

VITec Visual Information Technologies Inc.
3460 Lotus Drive, Plano, Texas 75075
800-325-6467 (214)596-5600

RasterFLEX, RasterFLEX-32, RasterFLEX-8, and RasterFLEX-HR are trademarks of Visual Information Technologies Inc. OpenWindows is a trademark of Sun Microsystems Inc. X Window System is a trademark of MIT. SPARC and SPARCstations are trademarks of SPARC International Inc.

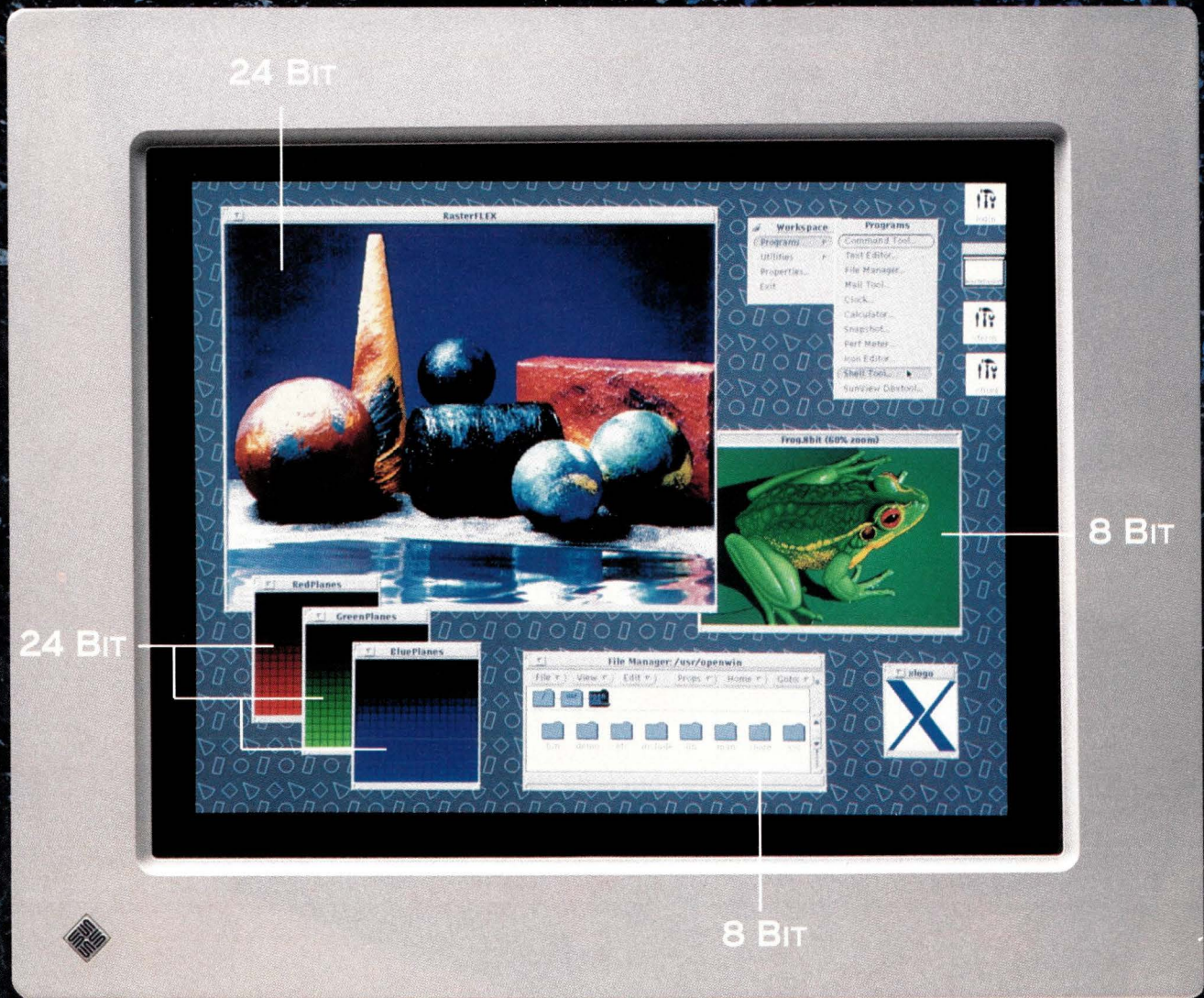

Courtesy of Kleiser-Walczak Construction Co.

Courtesy of Metrolight Studios

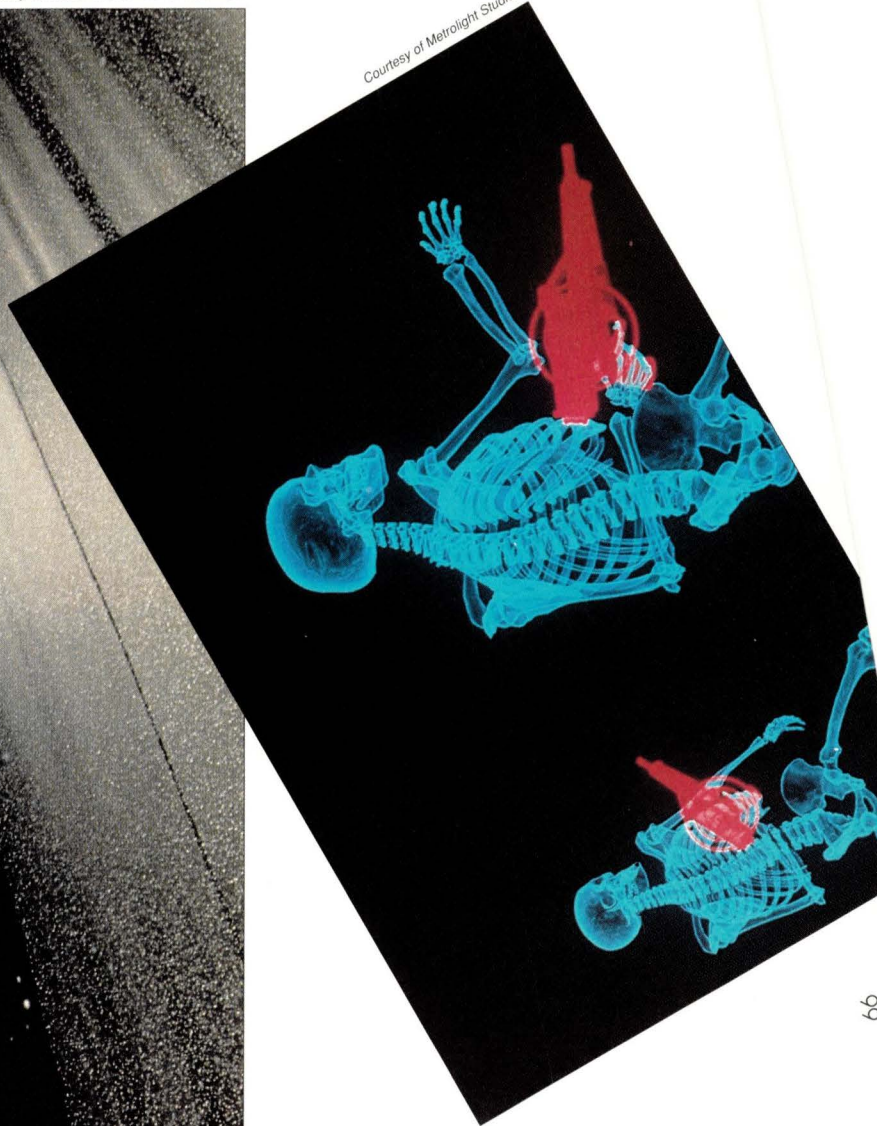

That's Entertainment!

by MICHAEL JAY TUCKER,
Executive Editor

For a machine that's not supposed to be a graphics platform, Sun Microsystems Inc. workstations show up in the darndest places. The movies, for instance.

Computer animation for major motion pictures is among the most glamorous, demanding and expensive of modern computer applications. While there is a growing number of firms offering such services, those which do so successfully on a long-term basis remain a mere handful. Among that tiny few, almost none uses Sun workstations for the actual production of animation.

That is not to say that Suns and other SPARC-based systems are absent. For, if they are not being used in animation, they are being used for almost everything else. They are, in effect, the general-purpose machines that hold together networks of more specialized graphics devices.

Professional Smoke and Mirrors

Thomas R. Schroeder is systems manager, administrator and programmer ("basically I'm the UNIX guru around here") at a company that can-

not be named. His firm's public-relations department has recently instituted a policy of strict non-cooperation with the computer-oriented press. But, Mr. Schroeder volunteered to be interviewed, anyway. To protect him from the wrath of his own PR department, *SunExpert* will not identify his company directly.

However, suffice to say that his firm is perhaps the most famed of all the special-effects operations in Hollywood today. For over 15 years, it has provided visually stunning images for dozens of hit films. It has created battling space ships, extra-terrestrials on flying bicycles, poltergeists, exploding Nazis, and, in this past summer's hit, a killer android composed of molten metal.

"Here," says Mr. Schroeder, "we do most of the heavy-duty rendering on Silicon Graphics [Inc.] boxes." But, he notes, there are Suns in place as well. "They're our generic workhorses." They are the machine on which general-purpose computing is regularly done. If it is computing, but it isn't rendering, then it's usually done on a Sun.

More importantly, the Suns per-

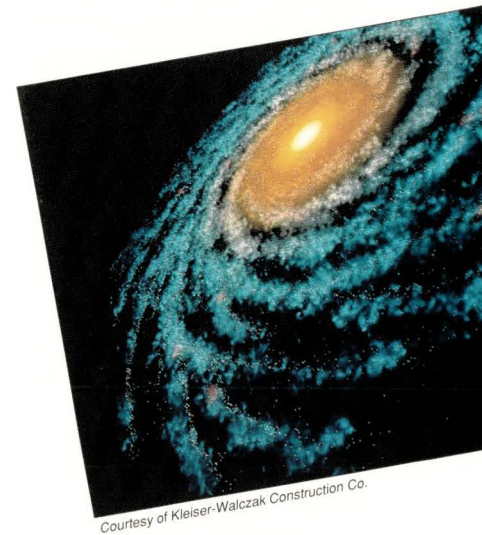

*A*mong the most demanding applications of computer graphics are film and video. Even here, SPARC-based systems are finding a role.

form an interface role. "We use them," says Schroeder, "basically for what you might call image processing." But, he means by this something different from traditional imaging. The company uses multiple clusters of SGI machines to do the actual animation. But, Suns then act as the link between the individual clusters and the world at large. In effect, the Suns are the oracles that put data into the clusters, and take finished images out.

Schroeder says that his biggest concern is his network, which must pump huge amounts of data through many different nodes. "We've done such things as collapse gateway boxes just because of the level of traffic," he says. "We had one that collapsed every day at just about 3:30 in the afternoon. We had people taking bets—would it go down today at 3:29? Or 3:31?"

What would make his life easier?

"Well, sub-netting helps," he says. If he could advise workstation makers, though, he'd tell them, "To have a stronger hold in graphics they should change their architectures a bit and move toward multiprocessing. It seems to help a bit. You don't have one function grab the whole CPU." And he should know. "We have SGIs that are running so hard they shut down their own accounting operations."

MetroLight and SPARC

A company that is not using Suns, but is using SPARC, is Metrolight Studios. Metrolight is another of the leading lights of the movie industry's computer-graphics providers. "We've sort of veered away from broadcast graphics," says Tim McGovern, the company's director of production. "It is kind of boring for us. We like the challenges of film work."

Mr. McGovern has dealt with challenging technical assignments on a regular basis. Prior to Metrolight, he was one of the animators on the now-famed "Sexy Robot" animation seen at virtually every graphics show. At Metrolight, he directed the computer effects for the recent thriller, *Total Recall*.

Like Mr. Schroeder's company, Metrolight uses SGI machines for its animation. But, for much of everything else, it uses Solbourne Computer Inc. systems. "Solbourne does most of our true computing," McGovern notes. "We use them as file servers, and to link to our film recorder."

Metrolight bought Solbournes because they are standards-based products. "We decided to go with something like a Sun, because it would connect to so many other things," he explains. Connectivity was a major

Video Ventures

If film isn't a field Sun Microsystems Inc. itself finds particularly interesting, video is quite another story. Video fits in with Sun's stated intention to enter the commercial markets. At Siggraph '91, Sun CEO Scott McNealy envisioned every business office equipped with video servers, pumping information to executives' workstations. "People won't write reports any more," he predicted. "They are going to produce *60 Minutes* segments."

While business executive as video producer remains still some ways off, there are already several products that put video on Sun screens. Sun itself offers an inexpensive route to at least some video functionality in the form of the VideoPix board.

A number of third parties offer higher-end solutions. Parallax Graphics Inc. is one such, and it has just released a new product, the Xvideo SBus board. "Basically, it allows you to display photorealistic images combined with video input and output," says John Ricketson, Parallax's vice president of marketing. At a price of \$5,995, the product integrates real-time video digitizing, graphics and image compression. Ricketson says that the product may be particularly useful to corporate media

divisions, in that with it, "you could do video editing in the computer...you could generate a reasonably professional tape with nothing more than a VCR."

Another player in the same market is RasterOps Corp. RasterOps has multiple products for SPARCstations, as well as a long history in bringing video to the Apple Computer Inc. Macintosh. In May 1991, the company purchased yet another firm, Truevision Inc., one of the more important names in graphics and video for PCs.

Still another vendor is RGB Spectrum, which offers both video boards, and boards that support specialized video functions. Last July, for example, RGB introduced a high-resolution video mixer, which combines the video outputs of two or more computer displays.

For users who don't want additional hardware, a software solution exists as well. Paradise Software Corp., for example, offers a set of several software products that allows users to put limited motion video on their Suns without additional hardware. "Ultimately, every computer will have native video hardware," says John A. Melleo-Roach, the company's managing partner. "But, until we have hardware on every machine, we have a low-cost, software-only approach."

Putting It On Film

To get computer graphics from the computer to film, you need a film recorder. The problem is, most film recorders are expensive. Now, however, low-cost options are starting to appear. Last July, for instance, Polaroid Corp. and Apunix Computer Services announced an agreement under which the two companies would provide digital-film-recording capability for Sun Microsystems Inc. workstations.



Courtesy of Polaroid Corp.

Polaroid's side of the bargain is the Digital Palette CI-5000. Apunix, then, has developed the SCSI driver, NeWSprint driver and raster file filter that makes the CI-5000 compatible with Suns. Apunix is also marketing the product.

With the CI-5000, users can create 35mm slides, overhead transparencies, prints or chromes. Pricing begins at \$5,995.

necessity, given the fact that the company has a very heterogeneous network.

McGovern isn't sure where he will go next for hardware. He admits that Suns are starting to have at least some appeal, even in animation. "The Suns are interesting," he says, "because they're getting faster."

As for software, McGovern says that Metrolight now uses mostly its own internal applications, though that might not last forever. The company originally used software from Wavefront Technologies, but developed its own after 1988. "People began to feel that the ISVs weren't developing as fast as they should have."

However, he says, the ISVs are now hurrying to catch up, and McGovern thinks they soon will. "I mean, you have to compare their horde of 70 programmers to our five."

Vaster Than Worlds

At the very opposite end of the spectrum from Mr. Schroeder's company is Kleiser-Walczak Construction Co. It is quite small—just two peo-

ple—and has no Suns or SPARC-based systems at all. However, the company's own history, and particularly its use of inexpensive, general-purpose hardware, may say much about the future of computer animation.

"We started this company in 1987," says Jeff Kleiser, who is 50% of the company; the other 50% is Dianna Walczak. "We decided to form a small company...and thought we could be competitive if we made some rules...and stuck to them." Specifically, they decided to keep their company as small as possible, to keep their hardware costs to an absolute minimum, and to limit their assignments to one or two projects, but to do those very well.

Walczak and Kleiser had complementary skills. Kleiser had a background in computer graphics. In fact, at another firm, Kleiser had done many of the computer-generated special effects on the film *The Flight of the Navigator*. Walczak was a sculptor. She created clay images, which Kleiser then digitized. The result was a computer-generated character—"we call them syn-

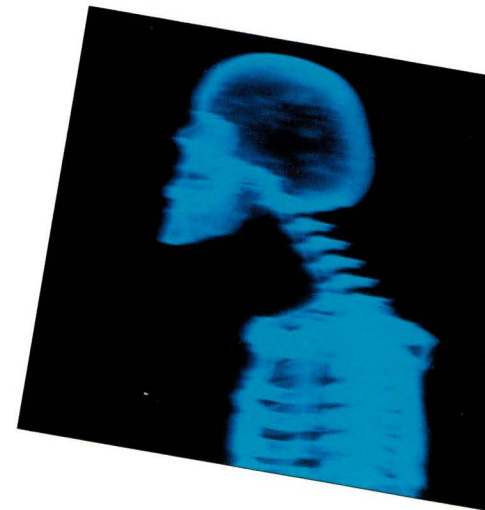

Courtesy of Metrolight Studios

thespians"—which can be manipulated electronically. One of these, a female figure, "starred" in the Kleiser-Walczak production *Don't Touch Me*, which was selected to be shown at the 1989 Sig-graph graphics theatre. In the computer-animation business, this is like saying it received an Oscar.

More recently, the team was selected to do the computer-generated effects for the KCET series, *The Astronomers*, which was broadcast nationally on PBS. Along with collaborator John Grower of Santa Barbara Studios, they did a series of photorealistic images showing such cosmic phe-

nomenon as black holes, the Milky Way and the sulfuric volcanos of Io.

What are they doing all this on? Says Kleiser, "Well, we've got an old SGI, an HP 835...which is obsolete now, but was top-of-the-line in 1989, and...oh, yes, we also have a Tektronix workstation." They got it cheap when Tek pulled out of the workstation business. "Tektronix says they'll only support it for two years, but hey! In two years anything we bought would be obsolete, anyway."

Suns are cheap, too. Why, then, didn't they consider them for their development? The answer is software.

"We own three Wavefront licenses," Kleiser says. "And Wavefront has only recently ported its product to Suns."

That's Show Biz

What, though, is the commercial 3D business like? For one thing, it is growing. "When I started in this business, there were maybe 15 companies in the world who did computer graphics," says Kleiser. Computer-graphics people seem to delight in that. "It is the kind of business you're in because you love it," says Metro-light's McGovern. "It is not going to make you a ton of money." ➔

Companies Mentioned In This Article

Alias Research Inc.

110 Richmond St., East
Toronto, Ontario
Canada M5C 1P1

Circle 100

Applix Inc.

112 Turnpike Road
Westboro, MA 01581

Circle 101

Apunix Computer Services

5575 Ruffin Road, Ste. 110
San Diego, CA 92123

Circle 102

Clarity Software

2700 Garcia Ave.
Mountain View, CA 94043

Circle 103

Computer Support Corp.

15926 Midway Road
Dallas, TX 7524

Circle 104

Corel Systems Corp.

The Corel Building
1600 Carling Ave.
Ottawa, Ontario
K1Z 8R7 Canada

Circle 192

Datacube Inc.

4 Dearborn Road
Peabody, MA 01960-3851

Circle 105

Du Pont Pixel Systems

2000 Edmund Halley Drive
Ste. 590

Reston, VA 22091-3436

Circle 106

Ficor Inc.

10250 Chester Road
Cincinnati, OH 45215

Circle 107

Imaging Technology Inc.

600 West Cummings Park
Woburn, MA 01801-6343

Circle 108

Informix Software Inc.

4100 Bohannon Drive
Menlo Park, CA 94025

Circle 109

Intelligent Light Inc.

P.O. Box 65
Fair Lawn, NJ 07410

Circle 110

Island Graphics Corp.

4000 Civic Center Drive
San Rafael, CA 94903

Circle 111

K L Group Inc.

134 Adelaide St. E., Ste. 204
Toronto, Ontario
Canada M5C 1K9

Circle 112

Paradise Software Inc.

RD 1, Box 467A
Lambertville, NJ 08530

Circle 113

Paragon Imaging Inc.

171 Lincoln St.
Lowell, MA 01852

Circle 114

Parallax Graphics Inc.

2500 Condensa St.
Santa Clara, CA 95051

Circle 115

Pixar

1001 West Cutting Blvd.
Point Richmond, CA 94804

Circle 116

Precision Visuals Inc.

6230 Lookout Road
Boulder, CO 80301

Circle 117

Ramtek Corp.

1525 Atteberry Lane
San Jose, CA 95131-1412

Circle 118

RasterOps Corp.

2500 Walsh Ave.
Santa Clara, CA 95051

Circle 119

Research Systems Inc.

777 29th St., Ste. 302
Boulder, CO 80303

Circle 120

RGB Spectrum

2550 Ninth St.
Berkeley, CA 94710

Circle 121

Silicon Graphics Inc.

2011 N. Shoreline Blvd.
P.O. Box 7311
Mountain View, CA 94039-7311

Circle 122

SoftImage Inc.

3501 Blvd. St-Laurent, Ste. 214
Montreal, Quebec

Canada H2X 2V2

Circle 123

Spyglass Inc.

701 Devonshire Drive, C-17
Champaign, IL 61820

Circle 124

Stardent Computer Inc.

6 New England Tech. Center
521 Virginia Road

Concord, MA 01742

Circle 125

Statistical Sciences Inc.

1700 Westlake Ave. N., Ste. 500
Seattle, WA 98109

Circle 126

Sun Microsystems Inc.

2550 Garcia Ave.
Mountain View, CA 94043

Circle 127

TaraVisual Corp.

929 Harrison Ave.
Columbus, Ohio 43215

Circle 128

Thomson Digital Image Inc.

1270 Ave. of the Americas
Ste. 508

New York, NY 10020

Circle 129

T/Maker Research Co.

1390 Villa St.
Mountain View, CA 94041

Circle 130

Uniras Inc.

5429 LBJ Freeway
Ste. 650, LB 144

Dallas, TX 75240

Circle 131

Vicom Systems Inc.

46107 Landing Parkway
Fremont, CA 94538

Circle 132

Visual Information Technologies Inc.

3460 Lotus Drive
Plano, TX 75075

Circle 133

Wavefront Technologies

530 East Montecito St.
Santa Barbara, CA 93103

Circle 134

Wolfram Research Inc.

P.O. Box 6059
Champaign, IL 61821-6059

Circle 135

Introducing FastPort. The first, the fastest, and most flexible
UNIX print server for under \$1,000.00.



UNIX printing just became this easy. It's simply a matter of having the right connections . . .

When we decided to create our UNIX print server we knew it had to be well connected. So we built-in full support for TCP/IP and all the most popular versions of UNIX from the leading workstation vendors such as SUN, HP, DEC, and IBM. We equipped it with a high speed serial port and a high speed parallel port so your favorite printers will become fluent in TCP/IP. We eliminated all the cabling hassles by including 10BaseT, Thinnet, and Thicknet ports.



Our host software installs in seconds; It's that easy. And printing with FastPort won't slow you down. It is designed to stay ahead of today's super-fast printers and plotters. When you're using X or ASCII, workstations or mainframes, any printer can now become a network printer. When determining the future of your UNIX printers, give them the power we gave our FastPort. Make sure they all have the right connections . . .
\$899.00 US list Price.

MiLAN. Doing more for less.
Please inquire about our full line of Ethernet connectivity products.

Call for the dealer nearest you.
415 • 968 - 9000
FAX 415 • 968 - 9046
E-Mail: fpinfo@milan.com



MiLAN Technology Corporation
67 East Evelyn Avenue, Suite 10
Mountain View, Ca. 94041

December 8-12, 1991
Washington D.C. Convention Center

The **ONLY** UNIX
Conference and
Exhibition Dedicated
Exclusively to the World's
Largest UNIX Marketplace

**The Federal Government
and its Suppliers**

FedUNIX'91 Distinguished UNIX Courses

December 10-12, 1991

The 20 most popular and authoritative full-day courses
from national UNIX, Graphics, and Security Conferences.
100% MONEY BACK GUARANTEE

Federal Open Systems Conference (FOSC'91)

December 10-11, 1991

- ★ DoD's CIM Program: The Biggest Open Systems Initiative
Keynote by Dr. Paul Strassmann, DoD
- ★ Selecting The Right Standards For Open Systems
- ★ Downsizing: Moving Applications from Proprietary
Systems To Open Systems

Plus 4 & 5 Day Hands-On Courses

January and March 1992

The X-Window System, UNIX Fundamentals, and C Programming
Hands-on courses taught by some of America's best Instructors.

Free FedUNIX Conference Sessions

December 10-11, 1991

Answers to the most commonly asked questions about UNIX—
Vendor Comparisons. *Keynotes by SCO & AT&T Top Executives*

Free Network Computing Shootouts

December 11, 1991

What networking hardware and software is best for your application.
Keynote by Banyan Systems & Novell Top Executives

**The Only Exhibition Of UNIX and Open
Systems Products for the Federal Marketplace**

December 10-11, 1991

All the major players in open systems are coming back: SCO, SUN,
UNIX International, Open Software Foundation, IBM, Data General,
Hewlett Packard, NCD plus many more vendors.

MOTIF'91

The International Motif User Meeting

Co-Sponsored by The International Motif User Group
December 8-10, 1991

Motif Users from more than 20 countries are planning to meet
in Washington, during the FedUNIX'91 Conference Week.
Refereed papers in over 30 categories. A special table-top
exhibition of software and hardware for X Windows and Motif.

VISION'91

**The Annual Meeting of
Computer Graphics Users From Major
Corporations and Government Agencies**

December 11-12, 1991

The Most Popular Sessions from NCGA & Siggraph.

Register To Attend Today, For Details call
(301) 229-1062

Return this form to:

FedUNIX'91,
4610 Tournay Road, Bethesda, MD 20816
or FAX to: **(301) 963-5518**

I would like additional information on FedUNIX'91/
Motif'91/VISION'91. Send me your Attendance Brochure.

Please register me for the FedUNIX'91 FREE Conference
Sessions and Exhibition.

Name _____

Title _____

Organization _____

Address _____

City _____ State _____ Zip _____

Telephone _____

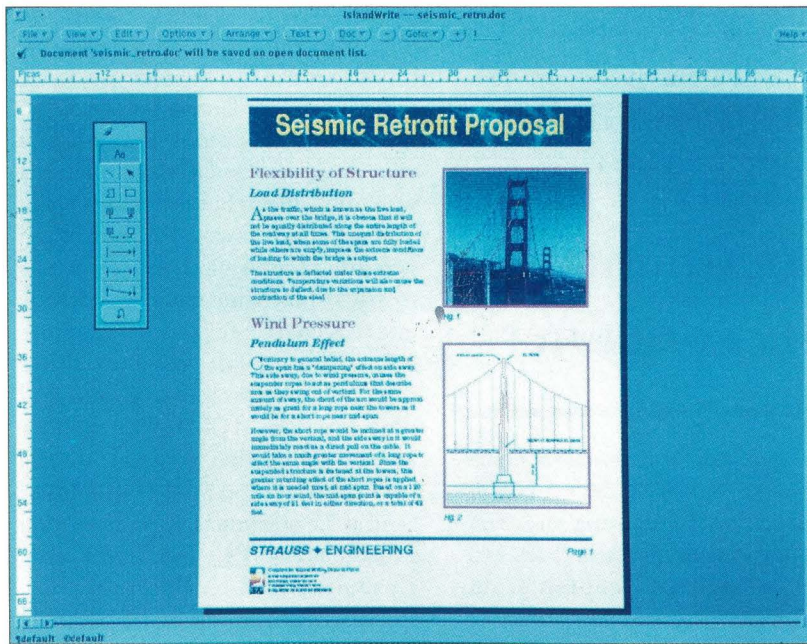

IslandWrite, a WYSIWYG text processor; IslandDraw, an "object-oriented" drawing package; and IslandPaint, an "object-oriented" drawing package, are three separate programs designed to work together and share many resources (such as their fonts directory).

Full-color text and graphical editing, along with a reasonably sophisticated WYSIWYG text processor, make IslandWrite, Draw and Paint a powerful document mill.

Island Graphics Corp. has done a service for the Sun community with three very capable yet low-cost tools: IslandWrite, IslandDraw and IslandPaint. Most likely you first heard of these products under the names SunWrite, SunDraw and SunPaint. Island Graphics has taken these products, originally developed by them and marketed through Sun, back in-house, enhanced them and produced new manuals; yet the price has stayed the same.

Most of us need to produce documents as part of our work. Some documents lend themselves to a simple text editor, e.g., the quick electronic mail message. At the other extreme are large documentation projects that demand sophisticated tools. Between these two extremes lies a vast middle. These modest documents range from one to perhaps a hundred pages and need some diagrams or a little pizzazz to get their point across. In other words, they are what most of us who don't prepare documents exclusively for a living do most of the time.

IslandWrite, IslandDraw and IslandPaint are three separate programs designed to work together and share many resources (such as their fonts directory). IslandWrite is a WYSIWYG text processor, reminiscent of Microsoft

A n Island in the Sun

by BARRY SHEIN, Technical Editor

Corp.'s Word. IslandDraw is used to draw structured pictures. You can change or move the objects later. IslandPaint is a bitmap-oriented tool intended to be used for touch up, editing or creation of bitmapped images.

I view these three tools as a hierarchy with IslandWrite at the pinnacle, and IslandDraw and IslandPaint as tools to be used to create graphical inclusions for documents. Don't be confused by this. The three tools can also be used independently, but this view of the tools matches well with most projects I have been involved in: A text document is created and, as you go along, you realize it would be nice to have a diagram, picture or chart to illustrate some point. In Island's work model you would fire up either IslandDraw or IslandPaint (or both), create the figure you want, and cut and paste it into the document. This is very easy to do: You just select all or part of the drawing, click Copy, create a container (more on these later) in your text document and paste the figure.

IslandWrite

IslandWrite is the main tool in this trinity. It is a handsome, WYSIWYG word processor with many of the features I would expect in a more expensive desktop-publishing tool. Operations chosen from the menu are organized in two ways. First, the familiar File, View, Edit, Options, etc., menu bar choices. Second, the logical organization of operations on different sets of objects: character, paragraph and document. Characters have qualities such as font, size, style and color. Paragraphs have justification, indents and leading. Whole documents have attributes such as page styles, tables of contents and indices, and footnote styles.

The central object in an IslandWrite document is the container. A container in IslandWrite is similar to a window placed in the text with its own boundaries for filling and clipping. It can either be rectangular or irregularly shaped.

To create a container, you choose one of the container tools (either rectangular or polygonal) in the tool

The central object in an IslandWrite document is the container

palette and draw your container much the same as you would draw a box or other object with a drawing tool. You can then paste another item (such as a figure created and copied from IslandDraw) into the container, or type text directly into the container. The figure in the container can be repositioned within the container area. The container itself can be moved around or resized. The picture within it will be clipped if necessary. Text in IslandWrite can optionally flow around containers.

You can also create containers within containers, useful for creating more complicated inserts. Text within containers will flow around containers within them. You cannot have both text and graphics in the same container. (You can have a graphics container within a text container, although they'd just be different containers. The distinction is almost academic.)

Another operation you can do with containers is link them. This causes text to flow from one container to the other. One simple use of linked containers is to create a document with multiple columns. This particular application, multiple columns, is common enough that there is an entry in the Page Attributes pop-up specifically for this. But you can also create multiple-column documents directly through manipulation of containers and their links.

IslandWrite supports several character fonts, styles, sizes, etc., as you might expect. In addition, you can specify text color from a simple palette menu of 30 colors and 20 shading

options. (This menu is used for other objects as well, so don't wonder too long why you might want a stippled text character.) For those of you accustomed to Apple Computer Inc. Macintosh word processors, Island doesn't offer those outline and shadow fonts. I won't miss them, but perhaps you will.

To bypass having to go through potentially multiple levels of menus to do something simple, such as insert a character from the symbol font, IslandWrite has something called the Incremental Command Line Interface (ICLI). This is their way of saying that you can use the keyboard for certain commands.

All ICLI operations begin by hitting a function key (F4...F8). In response, a prompt, such as Enter Symbol, appears near the top of the window and your next keystrokes are interpreted as ICLI commands. It will complete any unambiguous abbreviation so, for example, you can just type H for Helvetica. No other font name starts with the letter H.

The operations covered by ICLI are symbols, typeface (font), size, style (bold, italic, etc.), or paragraph attributes (center, left, first letter large, etc.).

Although better than no keyboard interface at all, I'm not very impressed with this particular approach. There's far too much reaching for function keys and interruption of the smooth flow of text entry. I'd prefer some sort of shift approach, perhaps using combinations of Control and Alt keys with mnemonic choices (e.g., Alt-B for Bold, Alt-I for Italic, etc.). Microsoft Word on the Mac uses this approach and it's nearly usable. OK, I don't know the perfect solution to this problem, but something more oriented towards the main keyboard area would be appreciated. Emacs-like motion controls would also be nice (e.g., Control-N for next-line), perhaps even a customizable method for assigning such functions to keystrokes.

There are four control sequences available from the keyboard (e.g., Control-S saves the current file) and many international characters can be inserted via Compose followed by a character.

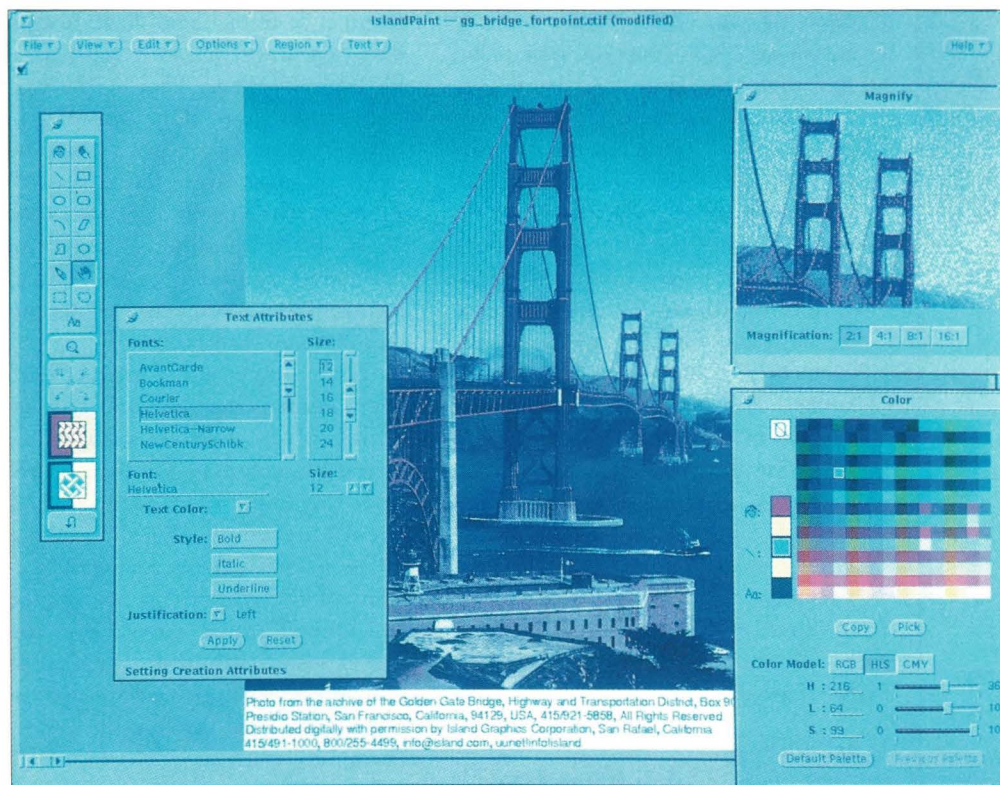

IslandPaint is a bitmap image editor. It can be used to draw a picture or manipulate a bitmap image (i.e., scanned).

One Control character, Control-N, kept biting me. I would hit this mindlessly to move to the next line (an old Emacs habit) and my document would disappear! Control-N means open a new document. The first time it took about 10 minutes to figure out how to get back to my document, and for a while I was sure it was lost forever. (IslandWrite doesn't automatically update the Open File directory menu, so the document you were working on does not appear for reopening.) This part of the interface could use some more thought.

If you use equations in your documents, you will find creating equations in IslandWrite plausible, but weak. You can get to many common math and Greek symbols and cause characters to be subscripts and superscripts. But notions such as stacking (e.g., putting the limits above and below a summation) are non-existent. I assume some playing around can produce adequate results, but this is not IslandWrite's strong card. It is probably adequate for the occasional equation only. (Island Graphics will be adding equation-editing and table-handling tools in the first quarter of 1992.)

There are optional vertical rulers and guides to help you position objects on a page. You can move tab markers around visually for different layout needs. These are handy and have become fairly standard in this sort of text processor.

The IslandWrite file format on disk is plain ASCII with markup commands (resembling SGML) embedded. This is suitable for inclusion in electronic mail with little or no preparation. I don't know if Island Graphics lists this as a feature of the product, but I certainly would!

IslandWrite can import documents from files in text (plain UNIX ASCII files), EPS, TIFF (a color bitmap encoding format) images, Lotus Development Corp. 1-2-3 and IslandDraw formats. Files can be saved to or opened from any of the following formats: SunWrite and other earlier IslandWrite formats, Frame MIF, Interleaf, MS Word (PC) and WordPerfect 4.2 or 5.0.

IslandDraw

IslandDraw is an "object-oriented" drawing package. This means that it remembers objects such as circles,

lines and boxes as whole or grouped units, and can operate on them at any time (e.g., change their size, move them around, change their color, etc.). This is reminiscent of the Macintosh's MacDraw program. IslandDraw seems like a competent tool with most options you would expect in a program like this.

The IslandDraw tool palette offers lines, boxes, ovals, lozenges, splines, polygons, text, etc. You can also choose among line sizes, fill and line colors and patterns and other attributes. Lines can have arrows at one or both ends. Drawing diagrams is a natural application of a program such as this. A fair amount of attention has been given to the bezier tools. These are algorithms for connecting a set of points with curves. There is an entire separate tool palette devoted just to tweaking your beziers.

An object editor (pop-up) lets you go back and tune various attributes of a selected object, such as changing its color or specifying mitred versus beveled joins.

Graphics created in IslandDraw can be copied into a clipboard buffer. Just

Just a Matter of Perspective

SUNEXPERT

Magazine offers a

spectacular view.

Managers and technical users

will find our product surveys,

built by our editorial team

of highly qualified Sun/UNIX

users, an indispensable

resource for making informed

purchasing decisions on the

latest hardware and software

products.

SUNEXPERT Magazine—

bringing the open systems

environment into perspective.

SUNEXPERT
Magazine

AN INDEPENDENT FORUM
FOR OPEN SYSTEMS

select the part of the picture, or all of it, choose Copy from the Edit menu and then paste into an IslandWrite container. It's very simple, and your intuitions will work. An image created in IslandDraw or IslandPaint can be put into an IslandWrite document either by copying it or by reference (in the latter case further changes within IslandDraw will show through to the IslandWrite inclusion). IslandDraw can import files in EPS (Encapsulated PostScript) and TIFF. Files can also be converted to and from the following formats: PostScript, EPSF, EPSI, CGM (a popular CAD format), SunDraw and earlier IslandDraw formats, and HPGL (Hewlett-Packard Co.). Files can be prepared for direct printing on Postscript (both black and white and color) and HP LaserJet and PaintJet printers.

IslandPaint

IslandPaint is a bitmap image editor. It can be used to draw a picture or manipulate a bitmap image (i.e., scanned), and presents a distinctly dif-

ferent style from IslandDraw. Images, once laid down, are no longer separable from the whole. They're just more bits on the page. For example, in IslandDraw, you can put a circle on the page and come back later to stretch it or change its color with a few clicks. With a tool like IslandPaint you cannot again refer to the circle as a circle, though you can alter the bits that make up the circle.

The typical way to interact with IslandPaint is via the Tool Palette, which offers a fairly rich set of operators including fill area, brush, line, rectangle, oval, lozenge, arc, parallelogram, polygon, convex polygon, and pencil. Arbitrary sections of the screen can be selected and rotated, scaled, moved, etc. You can choose from either two, 240 or 256 colors via the command line at start up, or later, through the Preferences pop-up.)

IslandPaint supports conversion from GIF, Group 3 fax, MacPaint, SunRaster and X11 bitmap and window dump. Files can be converted to TIFF, Group 3 fax, MacPaint, black and white or Color PostScript, HP LaserJet, HP PaintJet, SunRaster and X11 raster or window-dump formats.

We did have one small problem on the color IPC we used to try out IslandPaint. It seemed to be using a private-screen color map, so moving the mouse cursor to and from the tool palette caused rapid color changes. These almost certainly did not affect the actual image or file, just their appearance on the screen momentarily, but something wasn't perfect.

Summary

At a \$995 list price, these three tools represent an excellent value for the features they provide. Their support of full-color text and graphical editing, along with a reasonably sophisticated WYSIWYG text processor, makes them a great value. You can certainly find fancier products (at fancier prices). But for most people with general document and presentation needs IslandWrite, IslandDraw and IslandPaint fills the niche, and fills it quite nicely. ➡

more

The Island Productivity Series

**IslandWrite, IslandDraw and
IslandPaint**

Requirements:

OpenWindows and a mouse. Supports PostScript printers and X-terminals. Versions for platforms other than Sun are available, including DEC, IBM, SGI, etc.

Price: \$995 for a single network license

Island Graphics Corp.

400 Civic Center Drive
San Rafael, CA 94903

Circle 136

Take The Work Out Of Putting Workstations To Work.

**Introducing SunWorld Expo, Santa Clara, CA
April 6-9, 1992.**

Now you don't have to spend weeks researching to get up to speed on the latest workstation technology. You can do it all in four days, in one location.

SunWorld Expo, the Independent SPARC Products Show, is designed exclusively for professionals who buy, manage, or develop Sun and SPARC-compatible workstations, servers, hardware, software, and peripherals.

Visit over 300 exhibits.

The exhibit floor will feature over 300 booths displaying the latest products and services associated with SPARC technology, RISC, and UNIX. If you are considering a SPARC-based system, you'll find all the major vendors on the exhibit floor.

Attend dynamic conference sessions.

SunWorld Expo's conference program is an educational forum designed to help technical and non-technical users make informed buying decisions. Sessions will focus on the latest developments and most critical issues in networking and interoperability, client-server computing, distribution channels, network management, and service and support. And they'll include plenty of actual case studies.

What's more, each session will be led by industry experts including Andy Bectolsheim, Vicki Brown, Jeff Canin, Dr. Egil Juliussen, John Levinson, John Mashey, and Ed Zander. And you won't want to miss keynote speakers Scott McNealy, President and CEO of Sun Microsystems, and Ray Noorda, President and CEO of Novell, Inc.

It's backed by Sun, SPARC, and SunWorld Magazine.

SunWorld Expo is sponsored by *SunWorld Magazine*, the Independent Journal of Sun and SPARC Systems. It's endorsed by both Sun Microsystems, Inc. and SPARC International. And it's organized by World Expo Corp., the producer of MAC-WORLD Expo, the most successful trade show series in the world. So you're assured of a first-class event.



**Here's just some of the companies
who'll be at SunWorld Expo. Shouldn't
you be there too?**

Andataco Computer Peripherals •
Apex Computer • Digital Equipment
Corp. • Fujitsu Microelectronics Inc.
• Hitachi • HP/Apollo • Island Graph-
ics Corp. • JVC • Lotus Development
Corp. • Mitsubishi Electronics •
National Instruments Corp. • Open

Software Foundation • Parallax Graphics • Prime • RDI/
Trigem • R Squared • Solflower Computer Inc. • SPARC
International • Sun Microsystems • SunSoft, Inc. • *SunWorld*
Magazine • Tatung Science & Technology • Telebit Corp. •
UniForum • Workstation Technologies Inc.

Register by January 24 and get a FREE Exhibits Only ticket.

For more information, and to receive your Free Exhibits Only ticket, please complete the attached coupon and mail it to: SunWorld Expo, c/o World Expo Corp., P.O. Box 9107, Framingham, MA 01701-9107. Or call us toll-free at 1-800-225-4698. Can't wait? Fax it to us at 508-872-8237.

And take the work out of putting workstations to work.

Sign up for SunWorld Expo by January 24 and get a FREE Exhibits Only ticket.

- Please send my FREE Exhibits Only ticket.
 Please send me FREE conference information.

NAME _____

TITLE _____

COMPANY _____

STREET _____

CITY _____ STATE _____

ZIP _____ COUNTRY _____

TELEPHONE _____

FAX _____

SW8



SunWorld Expo is produced by World Expo Corporation, an International Data Group company, the world's leader in information services on information technology. World Expo currently produces 58 events in 20 countries, including ComNet and MACWORLD Expo.



UNIX *and*
Open Systems



UniForumTM

The International Conference of UNIX and Open Systems Professionals

January 22- 24, 1992
Moscone Center • San Francisco

UniForum '92:
the industry's
biggest & best
UNIX and Open Systems event

. . . complete with all
the products, the players,
the technologies,
the educational forums
and information updates
you need to succeed!

MORE EXHIBITORS: The exhibit floor at Moscone Center will showcase 300+ exhibiting companies, in 145,000 square feet of exhibit space, making UniForum '92 the largest UNIX and Open Systems event ever held in this country! Now in its ninth consecutive year, UniForum '92 features a diverse cross-section of major vendors, along with the newest start-up ventures.

MORE CONFERENCES: 25% more sessions than ever before • 105 separate presentations from which to choose • Tutorials spread over two days to double your opportunities • Conference sessions organized into 10 separate "tracks" to make your selections even easier and more rewarding.

MORE OPPORTUNITIES: UniForum '92 will give you the clearest understanding of the power of UNIX and the advantages inherent in the Open Systems revolution. *Advance registration for exhibits and introductory workshops is FREE.* And advance registration for the conference and tutorial program saves you money.

Call **800-323-5155** in the U.S. and Canada for complete conference details. International call: 1-708-260-9700. FAX 708-260-0395 Call today!

GO FOR IT!

UniForum '92 • 191 South Gary Avenue • Carol Stream, Illinois 60188 U.S.A.

Sponsored by
 **UniForum**TM
The International Association of Open Systems Professionals

UNIX is a registered trademark of USL.

NEW PRODUCTS

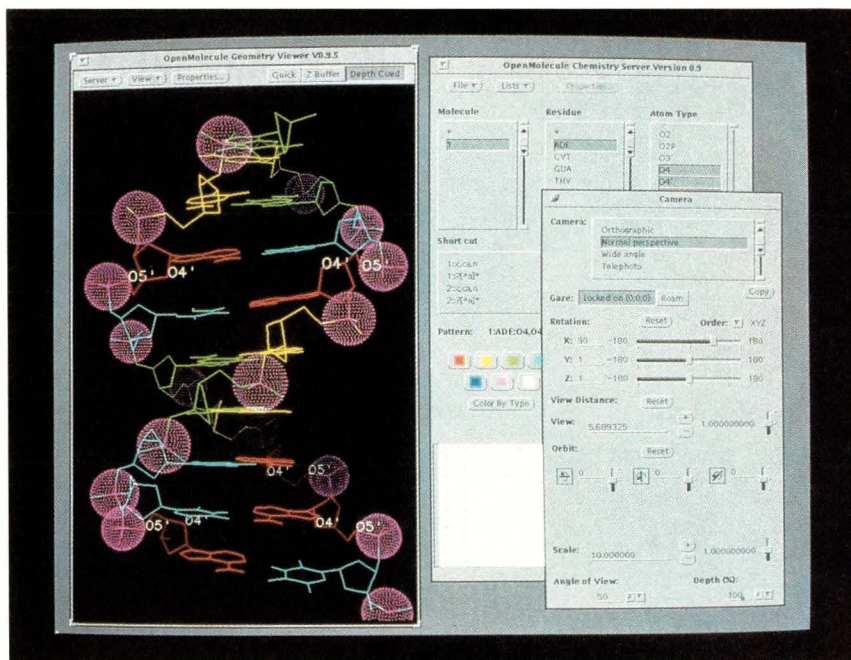

3D Molecular Modeling

anDATAco has introduced a software package for molecular modeling on Sun SPARCstations. Called OpenMolecule, the product allows researchers to dissect, display and measure complex chemical structures interactively.

OpenMolecule allows viewing of molecular dynamics trajectories and simultaneous display of multiple molecules, all with user-specified color coding, labeling and rendering. Up to nine molecules, each with its own local graphics transformation, can be displayed at one time. The software allows for the manipulation of up to 10,000 atoms per molecule and supports eight colors.

The product runs on OpenWindows and utilizes the XGL graphics library. The software adheres to the Open Look GUI. It also supports a distributed network protocol that allows for a program anywhere on a TCP/IP network to connect to the graphics server and generate graphics output.

OpenMolecule runs on SPARCstations, SPARCservers and

compatibles. Pricing begins at \$4,995. anDATAco Computer Peripherals, 9550 Waples St., San Diego, CA 92121.

Circle 137

VME Graphics Card

A graphics controller for VME-based systems has been introduced by PsiTech. The Graphics/1 is a 6U device based on the Fujitsu MB86990 graphics system processor. In its base configuration, the product features rendering speeds of up to 500,000 2D vectors per second and fill rates of over 100 million pixels per second.

A frame grabber can be plugged into an expansion slot of the board, making it able to accept NTSC, PAL and RFB video inputs. Another option is an i860-based accelerator, the Turbo CARD, which can increase the board's performance to 80K polygons per second. The Graphics/1 supports the X Window System and PHIGS software. Prices start at \$2,000 in quantity.

PsiTech Inc., 18368 Bandilier Circle, Fountain Valley, CA 92708.

Circle 138

Graphics Toolkit

Template Graphics Software has introduced FIGraph, a 3D charting and graphing toolkit for graphics software developers. FIGraph, which is based on PHIGS (Programmers Hierarchical Interactive Graphics System), provides software developers with a range of 3D formats, including scatter plots, function plots, splines, histograms, frequency polygons, pie charts, vector and contour plots.

FIGraph is based on Figaro+, TGS's implementation of PHIGS, which also provides an application programming interface to PEX, the 3D extension to the X Window System protocol. Pricing on the FIGraph toolkit varies.

Template Graphics Software Inc., 3510 Dunhill St., San Diego, CA 92121.

Circle 139



Scalable SBus Multiport

A group of SBus multiport cards for SPARCstations has been introduced by Helios Systems. Called HeliosPORT+, there are two products in the line: the SDM-4 with 4 asynchronous serial ports and one parallel port, and the SDM-8 with eight asynchronous serial ports and one parallel port.

Each serial port operates at 38,400 bps and uses RJ45 connectors. The SMD-4 is \$695; the SMD-8 is \$995.

Helios Systems, 1996 Lundy Ave., San Jose, CA 95131.

Circle 140

SUN USER GROUP

Ninth Annual Conference & Exhibit

December 9-11, 1991
San Jose Convention Center
San Jose, California

For the past eight years, the Sun User Group (SUG) has produced *THE* Sun user event of the year. The conference provides the opportunity for engineers, scientists, third-party vendors, end-users, developers, executives, and others to listen, share experiences, and learn how to better deal with both hardware and software decisions facing Sun and SPARC® users today.

The theme for this year's conference is, "Distributed Applications and Multiprocessor Technology" and will feature...

... Nearly 100 sessions and panels. In addition to presentations centering on the theme of the conference, also featured will be talks in the following five categories: Instructional, System Administration, Performance Analysis, Scientific Computing, and Commercial Applications.

... Tutorials will run all day Sunday, December 8. There will be eight tutorials which will run concurrently. Tutorial topics are:

- ▶ PERL
- ▶ Writing Distributed Applications Using the ONC Platform
- ▶ Micro-Kernel Technology
- ▶ Basic X Concepts
- ▶ Introduction to the Domain Name System
- ▶ UNIX Administration for VMS System Managers;
or, VMS + UNIX = Oil + Water?
- ▶ X and the Administrator
- ▶ Topics in UNIX Security

... Over 200 exhibits housed in a 100,000 sq. ft. convention center will make this year's exhibit the largest in our history, doubling the size of last year's show. See the latest Catalyst and third-party vendor products ported to Sun. Also included will be vendors from the SPARC® community.

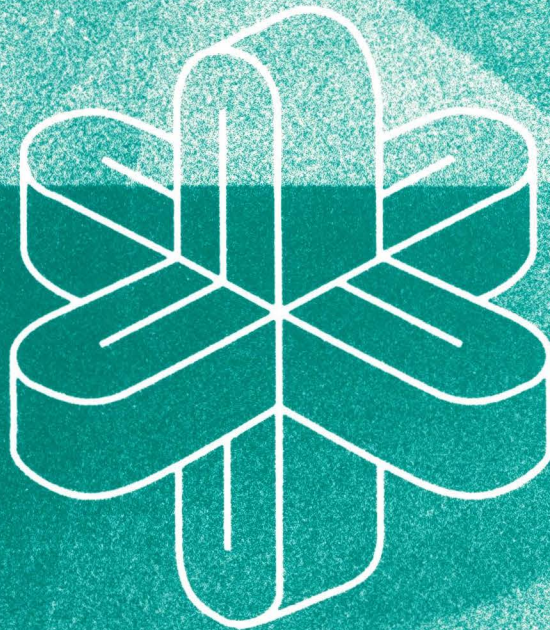

For registration or exhibit information please contact:
SUN USER GROUP CONFERENCE OFFICE
201 San Antonio Circle, Suite D265
Mountain View, CA 94040
415/948-0998 • Fax 415/948-6802



HDTV Video Disk

Recognition Concepts has introduced High-Definition TV (HDTV) models of its DataSTORE digital video disk product line. The devices allow users to store and display between six and 44 minutes of digital video in real time.

The DataStore HDTV models offer a variety of options to record and replay a number of different standard signals, including 32-bit digital RGB at a sustained bandwidth of 210 MB/s and 8-bit monochrome video at 70 MB/s.

Prices begin at \$223,000.

Recognition Concepts Inc., 341 Ski Way, P.O. Box 8510, Incline Village, NV 89450.

Circle 141

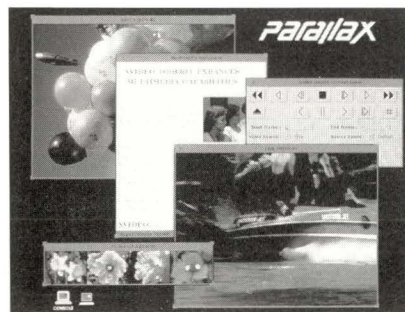

Video Options for SBus

Parallax Graphics has introduced two add-in cards that enhance its XVideo videographic controllers.

Designed for professional- and consumer-grade video formats respectively, the RGB and VIO option cards allow Sun workstations to display two live, full-sized video inputs simultaneously in separate windows on the workstation display.

The RGB option card is designed for use with component video formats, typically in professional video-production applications. The VIO option card is meant for consumer-video applications that use such video for-

mat as composite, Y/C and Super VHS. Both are daughter boards for the XVideo SBus card and are sold as an option on the XVideo product.

Price for both is \$7,990.

Parallax Graphics Inc., 2500 Condensa St., Santa Clara, CA 95051.

Circle 142

TV on Suns

RasterOps has announced the SPARC CARD TV, a single card that



Promises, promises...

Pie in the sky promises — not the best foundation for long-term customer relationships.

At Workstation Technologies, promises don't stay promises — they turn into customers who come back to us time after time.

Our pricing is real.

As an experienced reseller of Sun and Apollo, Workstation Technologies buys

aggressively, and passes the savings to its customers.

Our delivery is real.

Workstation Technologies ships you what you need **when you need it.**

Our quality is real.

All products are fully tested by technicians who have been carefully selected and trained in Sun and Apollo equipment. Technical support through

Workstation Technologies means faster, personalized service.

Workstation Technologies offers a complete line of products and services, plus depot repair, and industry-standard warranties.

Call today for an immediate response to your workstation needs.



BOSTON • SUNNYVALE

CORPORATE HEADQUARTERS
TEL: 800-882-0007
FAX: 603-890-6720

WESTERN REGIONAL OFFICE
TEL: 408-524-2910
FAX: 408-524-2912

We're a better source for workstations, subsystems, peripherals, spare parts, and upgrades

Circle No. 48 on Inquiry Card

Workstation Technologies is a registered trademark.

provides integrated video capability in one SBus slot. The Card provides a video window that can be re-sized and positioned on a Sun workstation screen.

The product supports NTSC, PAL and SECAM. Video signals can be used from such sources as TVs, VCRs, cameras and medical scanners. Since it occupies a single slot, SPARC CARD TV can coexist with Sun's own 8- and 24-bit graphics cards. Further, the CARD TV can use any standard Sun frame buffer.

Pricing begins at \$2,000.

RasterOps, 2500 Walsh Ave., Santa Clara, CA 95051.

Circle 143

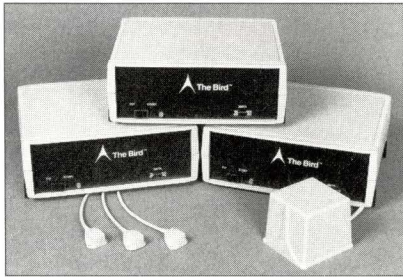

Birds Flock For Suns

A six-degrees-of-freedom input device for workstations, A Flock of Birds, has been introduced by Ascension Technology. Flock of Birds simultaneously measures the position and orientation of six receivers that are referencing their whereabouts to one or more fixed DC pulse transmitters. The product can be attached to the object being measured, including the computer user, for virtual-reality applications.

Other applications include the manipulation and control of multiple images on a graphics workstation, tracing multiple body parts for biomechanical analysis, and interacting with telerobotic controls. Bird receivers can be up to 36 inches from the transmitter. However, with an extended-range option, the transmitter can be up to eight feet from the product.

Pricing for A Flock of Birds begins at \$5,020. The extend-range transmitter is \$8,515.

Ascension Technology Corp., P.O. Box 527, Burlington, VT 05402.

Circle 144

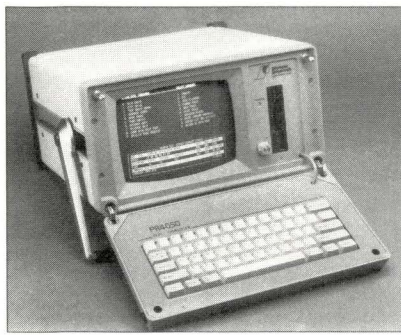

SCSI Disk and Tape Tester

Pioneer Research has introduced a portable SCSI disk drive tester that can also test tape drives as well as passively monitor a system SCSI bus.

The PR4050 Qualifier is a self-contained unit based on the Motorola 68K. With several built-in diagnostic programs, it can evaluate single-ended and differential SCSI disk drives, tape drives, and optical drives per ANSI SCSI-1 and SCSI-2 definitions.

The PR4050 can also be used as a passive bus monitor to log events on a system SCSI bus. It can sequentially test several peripherals at once. Results can be output on a printer or stored on IBM PC-compatible, 3 1/2-inch floppy disks.

Pricing begins at \$12,850.

Pioneer Research, 1745 Berkeley St., Santa Monica, CA 90404.

Circle 145

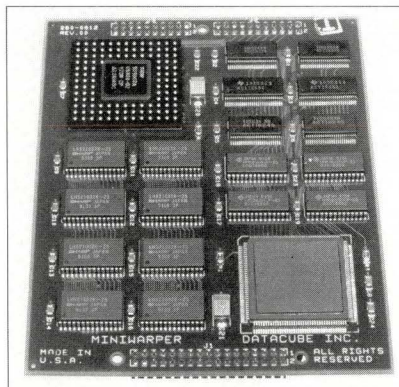

Sun Gets MiniWarped

DataCube had introduced an add-in module that provides video warping for its MaxVideo 20 image-processing system.

Called the MiniWarper, the product allows the MaxVideo to perform complex spatial warps of live video images.

Applications range from machine vision to photo re-touching.

MiniWarper performs first- and second-order polynomial warping of images up to 1K by 1K pixels at a rate of 20 million pixels per second.

Pricing begins at \$5,000.

DataCube Inc., 4 Dearborn Road, Peabody, MA 01960.

Circle 146

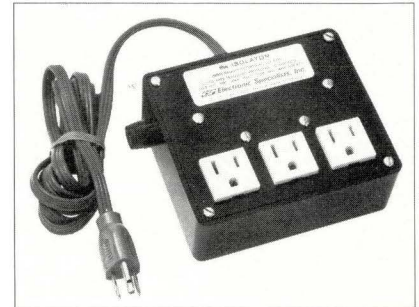

Network Power Protector

A surge protector has been introduced for networks by Electronic Specialists.

The Isolator protects networks from interference and damage caused by common-mode ground-surge current via ground chokes within the product's circuit control cable. The product also contains high attenuation, wide-band interference filters and high-energy 39,000-amp surge suppressors.

The Isolator offers suppressor response time of 1 pico-second. Options include power-fail interrupt, remote power switching and 20A capability. Options can be specified in commercial, industrial and laboratory grades.

Prices begin at \$100.

Electronic Specialists Inc., 171 South Main St., Natick, MA 01760.

Circle 147

Imaging on X-Terminals

XIE, the proposed imaging software standard for X Window System devices, is now available on NCD X-terminals. XIE extends the capabilities of X to include a set of image-rendering facilities, supporting bi-tonal, gray-scale and color images. It operates as an extension of the core X server, where the product provides conversion functions needed to match the characteristics of an image with those

of a display.

XIE is available on all new NCD terminals from the company. Owners of existing NCD terminals can purchase XIE for \$495 from NCD's software partner, Congruent Corp. of New York.

Network Computing Devices Inc.,
350 North Bernardo Ave., Mountain View CA 94043.
Circle 148

Studio Video On Suns

Studio-quality video output is now available for Sun SPARCstations. Applied Visual Computer has announced that it will adapt Tektronix's video-board system for Silicon Graphics machines, the Avanzar, for Sun workstations. Called the Solarzar, the device will allow workstations to produce very-high-quality video output in several different digital and analog formats.

Solarzar will provide real-time filtering and encoding. It will support several video formats, including digital component, digital composite (D2) in

parallel and serial formats, analog RGB, Betacam, MII, S-Video, and composite NTSC and PAL. Software tools include flipcard animation and ChromaMetrix, which analyzes images for color saturation and luma transitions.

Applied Visual Computing Inc., P.O. Box 3015, 149 Commonwealth Drive, Menlo Park, CA 94025.
Circle 149

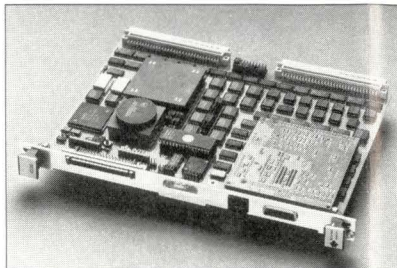

VME Controller With Fast Ports

Interphase has announced two products that combine storage, network and other I/O technologies for the VMEbus or VME64 bus.

The V/SCSI-2 4220 Cougar con-

trollers are 6U cards based on an intelligent SCSI-2 host bus adapter. The V/SCSI-2 4420 Cougar offers either one or two FAST SCSI-2 channels. The V/SCSI-2 4220 with Ethernet, the second product, is a single-channel FAST SCSI-2 adaptor with an intelligent Ethernet networking controller.

Both Cougars support FAST SCSI-2 data rates of 10 MB/s and the extended SCSI-2 command set. In addition, there is a dual SCSI-2 channel option on the Cougar. The single-channel Cougar is \$2,790; the double-channel Cougar and Cougar with Ethernet are \$2,790.

Interphase Corp., 13800 Senlac, Dallas, TX 75082.
Circle 150

Fujitsu's 2 1/2-inch Winchester

Fujitsu has entered the laptop/notebook storage market with its M263x product line. These drives offer low-profile (17mm) and proprietary power-management technology that maximizes battery life.

All four 2 1/2-inch Winchester disk

RED TAG SALE

<p>SPARCstation 4/40 FC8-P40 3-D Color Graphics \$9,995 list OFF LEASE SPECIAL \$6,500</p>	<p>SUN 2 3-D Color Graphics Workstation 4/75 GX-16-P40 \$19,995 list NOW \$14,995</p>	<p>JUST OFF LEASE 4/490 SPARCserver LOADED Call for Special Pricing</p>
---	---	---

OFF LEASE SPECIALS

SPARCserver ...4/330 GX8-P7	\$22,500
SPARCstation ..4/65 C8-P3*	7,900
SPARCstation ..4/60 M4-P3*	4,500
SUNstation3/80 M4	2,500
SUNstation3/60 C8 327 Disk, 60 MB Tape ..	2,495
SUNstation3/60 M8	1,995
SUNserver3/260 or 3/280 (many)	Call
SUN OS.....4.1.1 SS2-07 Cart Tape	250

Spare boards & parts available - Call

BUY • SELL • LEASE • TRADE
ALL SUN & DEC
"WANTED: USED SUN SYSTEMS"
(714) 632-6986
DATALEASE **FAX: (714) 632-9248**

Circle No. 13 on Inquiry Card

Token Ring

SBus Token Ring Card with TCP/IP support.

Low cost Token Ring connectivity between SPARC workstations, PCs, and IBM systems running TCP/IP and other protocols.

- Full IEEE 802.5 support
- Standard 4 M/tps data rate, link level throughput >95%
- Source routing with initial local ring determination
- Streams-based driver – SV.4 ready
- Support multiple cards and rings
- Built-in line traffic monitor

AURORA
TECHNOLOGIES

SPARC is a registered trademark of SPARC International

For Your SPARC® Workstation

SPARC International Member

Catalyst Advantage Program

Aurora Technologies
176 Second Avenue
Waltham, MA 02154
617-290-4800
617-290-4844 Fax

One Year Warranty • Money-back Guarantee • Lifetime Support

Circle No. 5 on Inquiry Card

drives are backed by a 150,000-MTBF rating and a comprehensive warranty program. Maximum storage capacity is 90 MB, average seek time is 18 msec and data-transfer rates are 5 MB/s and higher.

The configuration process is handled through the drives' SCSI and PC-AT interfaces using the company's Configuration Capable (C2) technology. C2 is a through-the-interface feature that facilitates rapid qualification and design-in.

Evaluation unit pricing begins at \$395.

Fujitsu America Inc., Computer Products Group, 3055 Orchard Drive, San Jose, CA 95134.

Circle 151

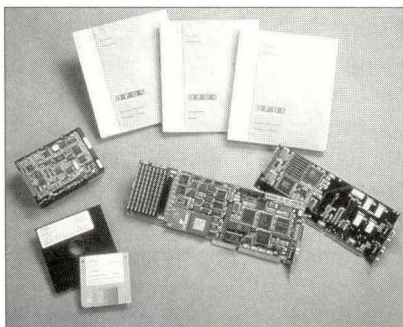

Presto: Your PC Is Now A Workstation

The Opus SPARCard Kit is a fully configured package designed to upgrade PCs to workstations with full Sun SPARCstation functionality. The kit includes all the necessary hardware, software, cables and documentation for end users to handle the complete integration.

Primary components of the kit are the SPARCard PC/AT add-in board, with a 25-MHz RISC chip, on-board Ethernet and two SCSI connectors; the PC3 color frame buffer, which occupies one SBus slot and supports PC fixed-frequency and multisync monitors; DOS interface software for file transfer between SunOS and DOS and switching icons to be switched between SunOS and Windows 3.0; and a 213-MB 3 1/2-inch hard-disk drive with SunOS 4.1.1 pre-installed.

A diskless configuration of the kit lists for \$4,495; the hard drive sells for \$1,135.

Opus Systems, 329 North Bernardo Ave., Mountain View, CA 94043.

Circle 152

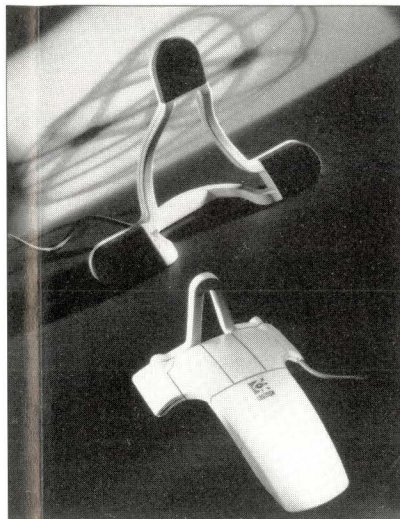

A New Breed of Mouse

Logitech has created a five-button, 3D mouse input device. The Logitech 3D Mouse supports multidimensional spatial graphics, such as CAD/CAM and virtual-reality workstations.

The mouse uses ultrasonic speakers and microphones to position itself. It can be used in multiple dimensions by raising it by hand or in a head-tracker unit off of the 2D plane or desktop. The 3D Mouse also can work as a conventional Microsoft/Logitech-compatible three-button mouse. The unit uses a standard RS232C connector.

Logitech Inc., 6505 Kaiser Drive, Fremont, CA 94555.

Circle 153

SPARCengine Board Includes Graphics

SMCC has introduced the SPARCengine IPX, a board-level product that includes a SPARC processor and Sun's GX graphics chip. In effect, it brings the newly defined graphics performance of Sun's desktop products to the emerging embedded SPARC-based system market.

The SPARCengine IPX is powered by a new 40-MHz SPARC microprocessor that combines integer and floating-point units on a single chip. The SPARCengine IPX squeezes all components (CPU, I/O, cache, mem-

ory, SCSI, audio, Ethernet, two SBus slots and GX graphics) into a 9-by-9.7-inch CPU board. It comes with 16 MB of memory, expandable to 64 MB.

The SPARCengine IPX runs Solaris 1.0 operating-system software as well as Sun's ONC networking software. It also supports the OpenWindows environment, which features the intuitive Open Look GUI and 15 DeskSet productivity tools.

Sun Microsystems Computer Corp., 2550 Garcia Ave., Mountain View, CA 94043-1100.

Circle 154

Imaging Products Appear

Fujitsu America has introduced three products as part of its document-imaging line. The M3096E+ is a high-performance scanner that offers 11.5-inch-by-17-inch paper-handling capability. The product shortens time between scans and allows for 20-ppm scanning of letter-size documents at 200 dpi.

Optional features include a dynamic-threshold circuit, which gives the scanner advanced OCR and document-reproduction qualities; an image-processing circuit, which improves image quality; a multilevel output interface, which offers the ability to extract true gray-scale at 8 bits per pixel; and a single connector interface, which enables OEMs and VARs to use one cable instead of two. List price for the M3096E+ is \$6,720; options are priced separately.

The company also announced its M3098A image scanner for very-high-speed scanning of large documents (up to 34 inches by 44 inches). The product has selectable standard resolutions of 200, 240, 300 and 400 dpi, and the ability to recognize 64 levels of gray scale. List price is \$59,995.

Fujitsu America Inc., 3055 Orchard Drive, San Jose, CA 95134-2022.

Circle 155

VME-To-SPARC Upgrade Plugs In

XINC Electronics' SPARCplug Lite provides a 28-MIPS upgrade path for VME-based Sun 3 or 4 systems.

The product provides users with a SPARC CPU and three available SBus slots. The resulting system supports both VME and SBus peripherals. SPARCplug Lite also supports up to 128 MB of SIMM RAM.

The product lists for under \$10,000. XINC Electronics, 3193 Tech Drive North, St. Petersburg, FL 33716-1006.
Circle 156

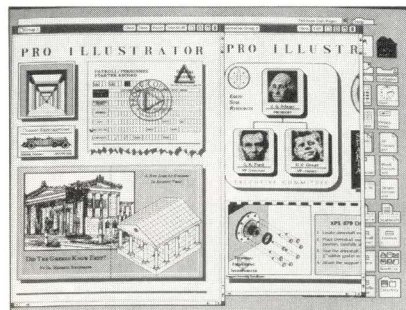

Highlight Color Laser Printer

Xerox has introduced its production-speed 4850 highlight color-laser printing system.

Using simple commands, businesses

can use color to highlight variable information such as names, account numbers, etc. The printer, which allows simultaneous printing of black plus one color, can be utilized as a black-only printer as well. The 4850 prints at 50 ppm with a resolution of 300 dpi. A 32-Mb font memory is expandable to 128 Mb. Average monthly print volume is 100,000 to 750,000 pages. The printer module measures 114 by 35.7 by 40.8 inches, and the system control module measures 48 by 28 by 41 inches.

List price is \$140,500. Xerox Corp., P.O. Box 24, Rochester, NY 14692.
Circle 157

Desktop Publishing for UNIX

Elan Computing Group has upgraded Avalon Publisher, the company's word-processing/desktop-publishing product for UNIX. The 2.0 version features color support, a mail-merge utility, enhanced graphics and filters for importing most major word-processing and DTP packages.

Publisher 2.0 runs under Open Look or Motif user interfaces and is available on such major UNIX platforms as the Sun 3, Sun 4, 386/486 PCs and RS/6000.

Price is \$995 per license. Elan Computer Group Inc., 888 Villa St., 3rd Floor, Mountain View, CA 94041.
Circle 158

Tek's X

Tektronix has unveiled a low-cost family of X Window System terminals. The XP10 Series brings plug-in network connectivity and windowing to workstations, ASCII terminals, PCs and Macs. All models include 4 MB of standard memory, 128 KB of ROM, an IBM 101 keyboard and a three-button mouse. TI's TMS 34020 was the graphic processor chosen and the series also features two custom ASICs. The performance rating for the monochrome XP11 is 44K Xstones. All four units feature 1024-by-768-pixel resolution (100-dpi) monitors with a 70-Hz refresh rate. Color dis-

Sun Storage Devices

- Hard Drives - Tape Drives -
- Custom Combinations -

Maxtor® Seagate
EXABYTE

Internal Kits	
MB-msec	
213-15	\$729
340-13	\$1329
426-14	\$1429

External Kits	
MB-msec	
340-13	\$1499
676-16	\$1899
1020-13	\$2899
1500-13	\$3499

External Combo	
676/2.5	\$4200
1.2/2.5	\$4900
676/150	\$2595
1.2/150	\$3295

Exabyte External Tape Drives	
2.5GB	\$2499
5.0GB	\$3600

 **(800) 543-6098**

Data Storage Marketing, Inc.
 5718 Central Avenue - Boulder, CO 80301

Circle No. 15 on Inquiry Card

Scan

Add high quality images to your printed material for exceptionally low cost.

The FirstScan™ product provides everything you need to use the Hewlett Packard ScanJet Plus with your SPARC workstation.

FirstScan software, using the OpenWindows™ GUI, provides full control of scanning process. Images can be saved in Sun Raster, PostScript®, or TIFF formats for easy integration into your documents.

Make the intelligent choice in SPARC workstation scanning —

AURORA
 TECHNOLOGIES

OpenWindows is a trademark of Sun Microsystems, Inc. SPARC is a registered trademark of SPARC International. FirstScan is a trademark of Aurora Technologies, Inc. PostScript is a registered trademark of Adobe Systems Corp.

For Your SPARC® Workstation



Aurora Technologies
 176 Second Avenue
 Waltham, MA 02154
 617-290-4800
 617-290-4844 Fax

One Year Warranty • Money-back Guarantee • Lifetime Support

Circle No. 6 on Inquiry Card

plays are also available. Networking users can choose from most major options: Ethernet, DECnet, etc. Terminals measure 15.75 by 14.25 by 14.75 inches and weigh 31 pounds. All are covered by a one-year warranty.

List prices for the X10 series begin at \$1,695 and run to \$2,895.

Tektronix Inc., P.O. Box 500,
Beaverton, OR 97077.

Circle 159

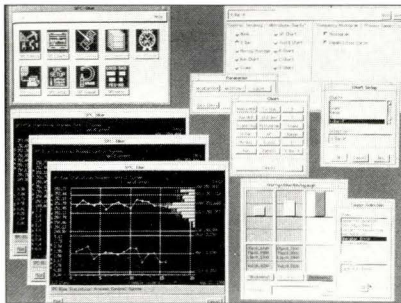

NEW Stat Software Debuts

NEW Technology has enhanced its SPC-Blue statistical process-control system with the X Window System and the Open Software Foundation's Motif. Version 2.0 makes use of object-oriented menus that guide users through definition and configuration.

The package includes all of its former features: automatic data collection, electronic digital gauge interfaces, bar-code data input, automatic warning alarms, full network support, short-run deviation from target spec, an SQL database and SPC report generator, full audit trail for data, assignable cause, and simple import and export of characteristic data. SPC-Blue runs on Sun SPARCstations, the IBM RS/6000 and Intel 386/486 machines running the Santa Cruz Operation's Open DeskTop.

DEC Ultrix and VMS versions will be available during the first quarter of 1992.

NEW Technology Associates Inc.,
P.O. Box 9227, Evansville, IN 47724.
Circle 160

Fusix For i860s

Du Pont Pixel Systems has announced that it will market Fusix, its real-time operating environment and microkernel for attached Intel 80860 processors.

Fusix includes not only a complete software environment, but also interfaces to the company's PX/GL, an emulation of Silicon Graphics' GL graphics library. PX/GL can be purchased separately.

Fusix provides a set of object-oriented concurrency paradigms, including locks, semaphores, events, messages, threads and processes. It contains several UNIX-compatible functions, and the company says that most C and FORTRAN can be compiled and run with no changes.

DuPont is making Fusix available in a variety of ways. The API definition is free. Source code is \$10,000.

Prospective users can evaluate the product with a \$495 run-time package called Fusix Prototyper.

Du Pont Pixel Systems, 2000
Edmund Halley Drive, Ste. 590,
Reston, VA 22091-3436.

Circle 161

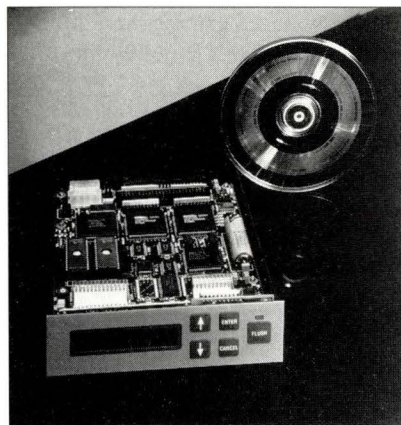

Optical Hardware Caching Interface

Ten X Technology unveiled the OCU 300, an optical-disk interface that utilizes hardware data compression for increased storage capacity and enhanced performance.

The interface implements the QIC-122 compression standard for optical drives and is capable of 1.5-MB/s compression and 5-MB/s decompression rates. The host computer communicates with the OCU-300 using standard operating-system commands for easy installation and operation.

System-specific software drivers are not needed to connect the OCU-300 to most writable optical drives, com-

puters and operating systems. List price is \$1,895.

Ten X Technology Inc., 4807
Spicewood Springs Road, Bldg. 3, Ste.
3200, Austin, TX 78759.

Circle 162

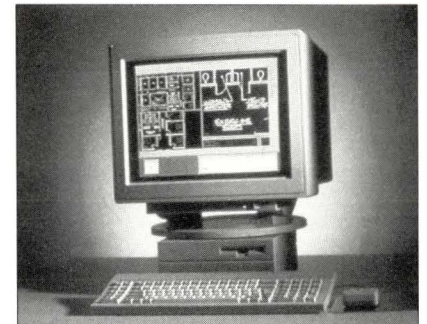

ESP On Open Look

An enhanced release of software that allows raster editing inside AutoCAD has been introduced by Image Systems Technology.

CAD Overlay ESP 3.5 views, edits and plots canned paper drawings in AutoCAD. The new version supports Open Look Release 11 and SunView, Release 10 or 11.

The product offers such raster-editing features as cut, copy and paste. In addition, it has a bidirectional converter for Sunraster (PIXRECT) binary format. This means a scanned image can be edited using ESP and AutoCAD, and can then be exported for presentation in a technical publication package. Pricing begins at \$2,495.

Image Systems Technology Inc.,
Rensselaer Technology Park, 165
Jordan Road, Troy, NY 12180.
Circle 163

Managing Documents on Suns

Xerox' GlobalView workgroup and document-management applications are now available on Sun SPARCstations. The Xerox Document Search and Retrieval (DSR), DocuTran automated translation and Xerox DocuTeam workgroup software are all available for the first time on UNIX, as are Xerox' Pro Illustrator, Chemical Illustrator and Equations packages.

All of the packages use Xerox' GlobalView icon-based GUI. At the same time, Xerox is delivering an

upgrade to its GlobalView networked desktop environment, VP 3.1. The upgrade provides uniform functionality for all Xerox platforms, including the Xerox 6500 UNIX workstations, 6085 workstations and OS/2 PCs.

Pricing is based on licenses and modules desired.

Xerox Corp., Xerox Centre, 101 Continental Blvd., El Segundo, CA 90245.

Circle 164

Aviator Runs On SPARC

Aviator Flight Simulator now runs on Sun's SPARCstation IPX and 2 GX plus accelerated color-graphics workstations.

The application allows users to interactively operate a simulated F/A-18 aircraft in real time against other users on an Ethernet network. The terrain is generated from data acquired from the U.S. Geological Survey.

Floating licenses can be ordered from software distributor Qualix Group Inc. for \$150. The product is available on CD-ROM or quarter-

inch tape. The company says it will make Aviator source code available during this quarter.

Aviator Horizons Inc., P.O. Box 51847, Palo Alto, CA 94303-0725.

Circle 165

Engineering for SUN

Varimetrix has announced Varimetrix Modeling, a 3D engineering-design product running on Sun workstations, which is aimed toward the engineering and manufacturing arena. Built around a Unified Parametric Geometry architecture, the product integrates wireframe, surface and solid geometric entities.

A special feature allows users to apply parameters to a model during the construction process or after initial design. A "spatula modeling" feature allows quick sculpting of solids. Full undo and redo operations are available and both NURB and analytic geometry are supported. The modeler provides complete on-line help.

List price is \$3,995.

Varimetrix Corp., 2350 Commerce

Park Drive, Ste. 4, Palm Bay, FL 32905.

Circle 166

Mac/PC Connectivity Software

Digital Instrumentation Technology has introduced FloppyWorks file-transfer software for SPARCstations and compatibles.

FloppyWorks allows a workstation to format, read and write Macintosh, MS-DOS and OS/2 3 1/2-inch diskettes. FloppyWorks supports SPARCstation internal drives. A command-line version of the product is currently shipping; an Open Look Version is planned for the year end.

Pricing is \$295.

Digital Instrumentation Technology Inc., 127 Eastgate Drive, #20500, Los Alamos, NM 87544.

Circle 167

FYI

The product descriptions are compiled from data supplied by the vendors. To contact them for more detailed information, circle the appropriate reader service number on the card located at the end of the magazine.

YOUR UNIX/SUN CONNECTION

Five Year Warranty on disks and disk subsystems - one year on tape. Quality products from Exabyte, Fujitsu, Hewlett Packard, Lantronix, Micropolis, Pinnacle Micro, Seagate, Tektronix, Telebit, Wangtek, Xylogics and many more.

Disk, tape, optical and removable subsystems; memory; controllers; printers; plotters; displays; terminal servers; modems; and a complete line of cables, including custom orders. **One call gets it all.**

800•876•7818

Circle No. 45 on Inquiry Card

UNISUN
PERIPHERALS



5893 Oberlin Drive, San Diego, CA 92121
619-558-7800 FAX: 619-558-8283

Company names and products are TM, ©, ® their owners.

ADVERTISER'S INDEX

SUNEXPERT Magazine

CIRCLE NUMBER.....	PAGE
1.....anDATAco.....	21
2.....Apex Computer.....	13
3.....Apunix Computer.....	25
4.....Artecon.....	7
5.....Aurora Technologies.....	83
6.....Aurora Technologies.....	85
7.....CenterLine Software.....	9
8.....Clearpoint.....	back cover
10.....Computer Upgrade.....	41
11.....Cranel.....	18-19
13.....Datalease.....	83
14.....Datalink.....	31
15.....Data Storage Marketing.....	85
16.....DSP Development.....	63
17.....Eakins Open Systems.....	60
18.....Engineering Design Team.....	26
.....FedUnix.....	72
19.....Hewlett-Packard.....	16-17
20.....Hewlett-Packard.....	51
21.....Hitachi.....	49
22.....IMSL.....	5
23.....Insignia.....	34
24.....I/O Tech.....	14
25.....Jaybe Software.....	12
26.....K.L.Group.....	62
27.....MiLAN Technology.....	71
28.....Mitsubishi Electronics.....	23
29.....National Instruments.....	45
30.....O'Reilly & Associates.....	8
31.....Pacific Access.....	27
32.....Parity Systems.....	inside back cover
33.....Polaris Service.....	33
34.....R Squared.....	2
35.....Rave Computer Association.....	15
36.....Research Systems.....	59
37.....Specialized Systems Technology.....	48
38.....Sun Microsystems.....	inside front cover
39.....Sun Microsystems.....	29
40.....Sun Microsystems.....	52-53
.....Sun User Group.....	80
.....SunWorld Expo.....	77
41.....Themis Computer.....	35
42.....Tracer Technologies.....	43
43.....Transitional Technology.....	37
44.....Trimm Industries.....	20
.....Uniforum.....	78
45.....Unisun Peripherals.....	87
46.....Universal Technical Systems.....	1
47.....Visual Information Technologies.....	65
48.....Workstation Technologies.....	81
49.....Xerox Imaging Systems.....	38-39

national sales manager: LINDA LIEBICH

SALES OFFICES

New England

Joan Donahue
The Donahue Company Inc.
31 Shipway Place
Charlestown, MA 02129
Phone: (617) 242-3042
Fax: (617) 241-2815

New York/Mid-Atlantic/ Southeast

Richard K. Felt
Phone: (215) 688-9342
Fax: (215) 688-3370

D. Douglas Johnson
Phone: (215) 935-8522
Fax: (215) 983-0655
Felt, Johnson & Associates
P.O. Box 199
Devon, PA 19333-0199

Mid-West/Mountain States/ Southwest

Linda Liebich
11782 Jollyville Rd., Ste. 102A
Austin, TX 78759-3966
Phone: (512) 331-7076
Fax: (512) 331-7788

Southern California/ Nevada

Diane Hargrave
World Savings Center
11601 Wilshire Blvd., 5th flr.
Los Angeles, CA 90025
Phone: (213) 575-4805
Fax: (213) 575-1890

Northern California/ Oregon/Washington

Robert S. Pack
1030 East Duane Ave., Suite F
Sunnyvale, CA 94086
Phone: (408) 732-0818
Fax: (408) 730-0702

Direct Response Postcards

Carol A. Flanagan
Manager, telemarketing sales
1330 Beacon St., Suite 220
Brookline, MA 02146
Phone: (617) 739-7001
Fax: (617) 739-7003

THE AD INDEX IS PUBLISHED AS A SERVICE TO OUR READERS. THE PUBLISHER DOES NOT ASSUME ANY LIABILITY FOR ERRORS OR OMISSIONS.

ARE YOU POWER HUNGRY?

If you are like most workstation users you probably need more power. Because running today's sophisticated software applications takes more power than ever before. It's time to consider an upgrade.

Increase the performance and flexibility of your workstation with an affordable memory upgrade from Parity Systems. Memory upgrades improve your system's response time and give you the capability to run complex software applications.

We can satisfy your need for power with low-cost 4 MByte and 16 MByte

SIMM expansion memory for your Sun IPX™ and ELC.™ Each upgrade includes an installation guide and comes with a lifetime warranty.

We also have a full line of memory boards and SCSI subsystems for Sun, IBM RS6000, DEC, Silicon Graphics and Solbourne workstations and file servers.

Let us satisfy your need for power. Call Parity Systems today at **408/378-1000.**



▼
PARITY

PARITY SYSTEMS INC. TEL 408/378-1000 FAX 408/378-1022
EASTERN REGIONAL OFFICE TEL 216/836-0247 FAX 216/836-4978

All product names are trademarks of their respective companies.

Circle No. 32 on Inquiry Card

The Only Fault-Tolerant Memory for SPARCserver 490 Systems

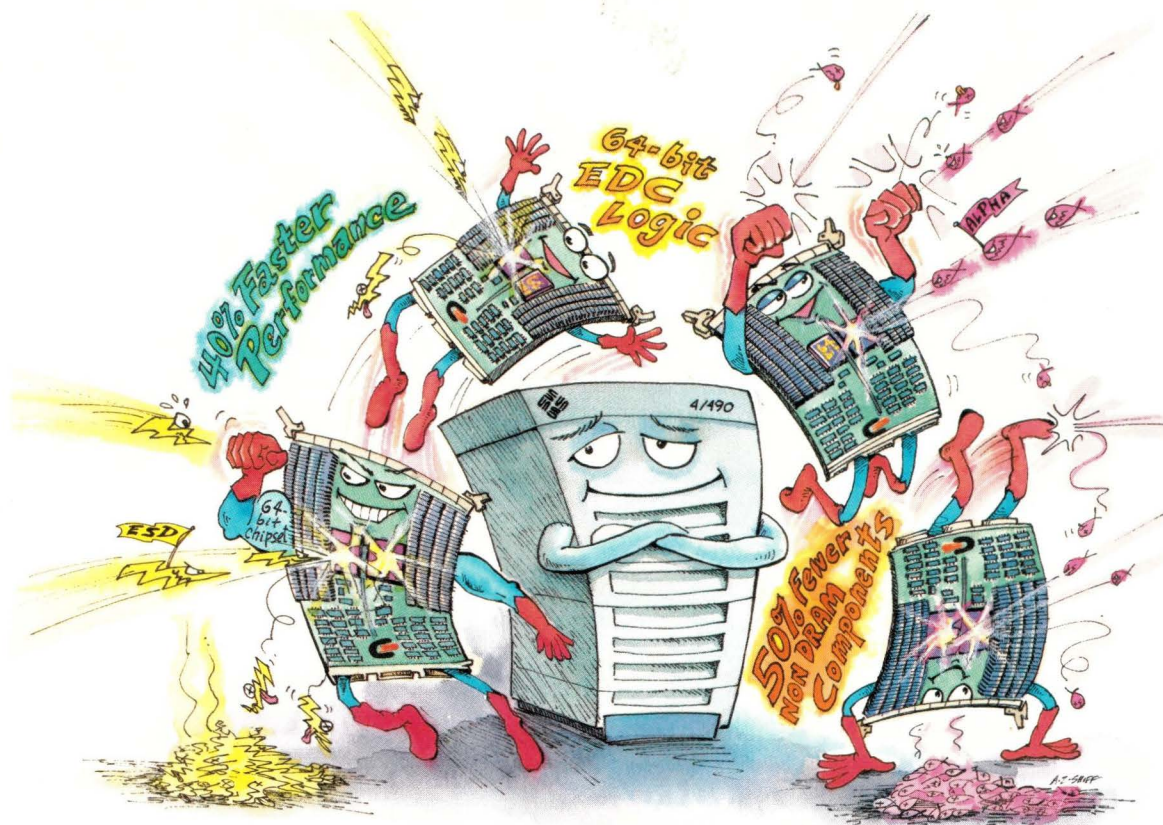

Unstoppable Memory from Clearpoint, of course!

Clearpoint's design philosophy strives for maximum reliability and superior value. Our SNME-490 memory for SPARCstation/SPARCserver 470 and 490 systems, available in 32 and 128 MB densities, is the only fault-tolerant solution for Sun servers.

Dynamic Bad-Bit Replacement
The Clearpoint 64-bit EDC chip set with dynamic bad-bit replacement provides fault tolerant operations. If the logic identifies a hard error, a spare DRAM is immediately swapped in to prevent the possibility of a system-stopping double-bit error. The chip set then reallocates the address range to the spare DRAM. If a soft error occurs – caused by ESD or alpha particles, for example – the EDC logic corrects the data and scrubs the location. All correction and remapping operations are transparent to the user.

Increased Performance

The SNME-490 operates up to 40% faster than Sun's 4/490 memory boards. Clearpoint takes full advantage of the Sun 64-bit memory bus by implementing a 64-bit EDC chip set (Sun uses 32-bit), allowing faster data transfers.

Increased Reliability is Built In
Clearpoint's hard-soldered DRAM solution provides a significantly better Mean Time Between Failure rate than a SIMM-based board.

Additionally, state-of-the-art components and high-level design integration have reduced the non-DRAM chip count on the SNME-490 by over 50%. A lower component count insures fewer field failures and less downtime.

Call or write for more information!

- SNME-490 spec sheet
- The Designer's Guide to Add-in Memory
- Pointers newsletter
- Memory Applications Casebook



CLEARPOINT

1-800-253-2778

Clearpoint Research Corporation
35 Parkwood Drive • Hopkinton, MA 01748
(508) 435-2000 1-800-CLEARPT

Circle No. 8 on Inquiry Card

Sun, SPARCstation, SPARCserver, 4/470, 4/490 are trademarks of Sun Microsystems.
Clearpoint and the Clearpoint logo are registered trademarks of Clearpoint Research Corporation.