

Formerly *SunExpert* Magazine

# Server/Workstation

## EXPERT

JULY 1999  
Vol. 10 No. 7 \$5.50  
<http://sw.expert.com>

**Solutions  
for hands-on  
IT managers**

### BACKUP PROS JUMP ON THE SANWAGON

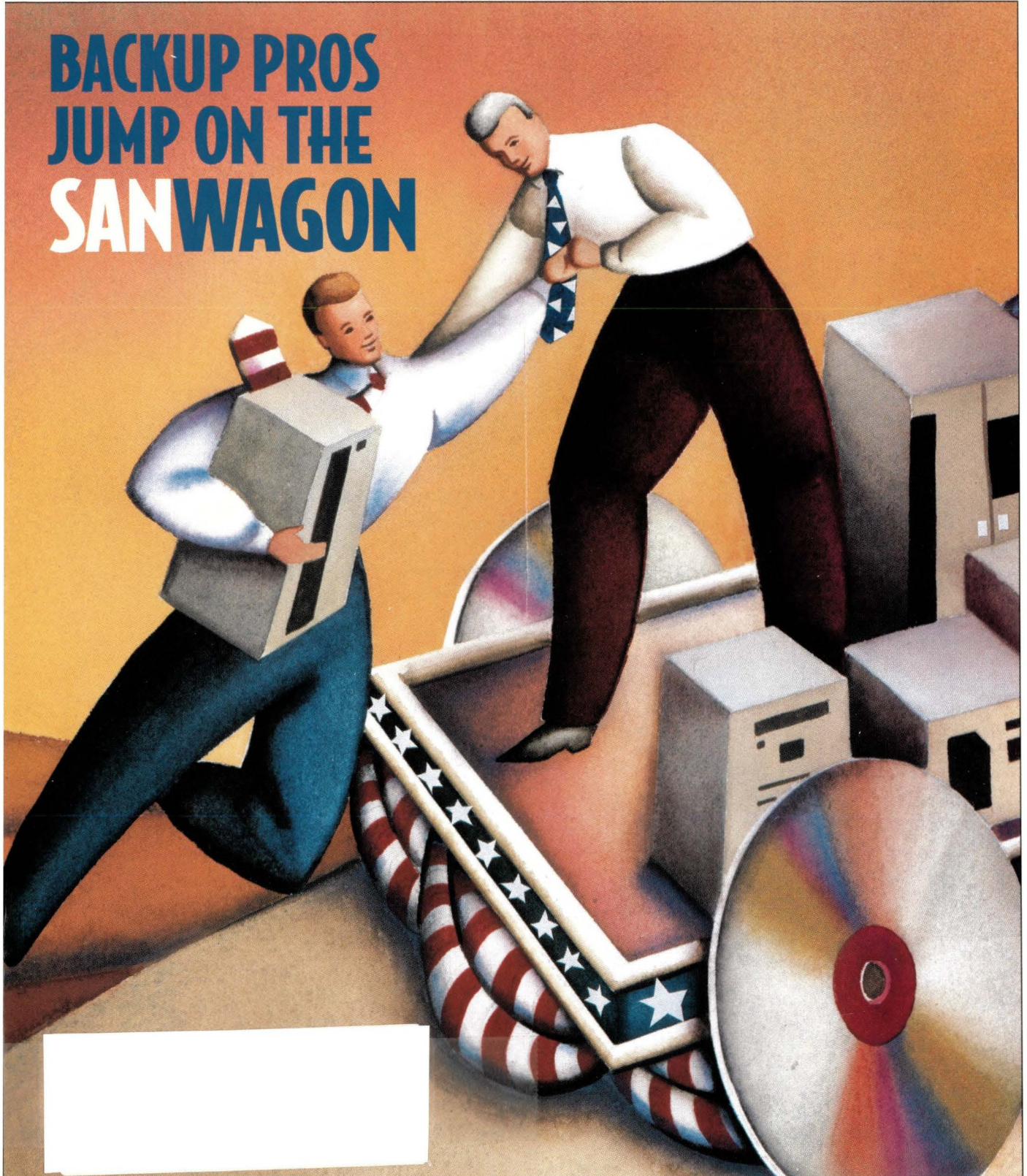

Survey: Networkable UPS Devices

Review: FlashDisk





**KINGSTON  
STORAGE.  
PROVEN IN NASA'S  
TOUGHEST TESTS.**



**THE NASA SPACE SHUTTLE USES KINGSTON'S**

Data Express® removable drive enclosures in space for the same reasons you can rely on them for your mission-critical applications here on earth. Kingston's Data Express delivers ultimate reliability and flexibility. Try our rugged DE200 for virtually every removable application, including RAID.

[www.kingston.com/storage](http://www.kingston.com/storage)

- Supports high capacity 3.5" standard half-height and LP drives
- Supports AT/IDE and SCSI including SCA and ULTRA
- Lock-down, all-steel carrier for shock and vibration applications
- Key lock for enhanced security
- Platform independent; bootable from any computer system
- Highly-rated mating connectors, up to 25K cycles
- Optional hot swap, solenoid lock features available
- Comprehensive 7-year warranty

Call a Kingston® consultant today at (800) 588-5526 to find out more about Data Express DE200. It's one of the most versatile removables in the solar system.

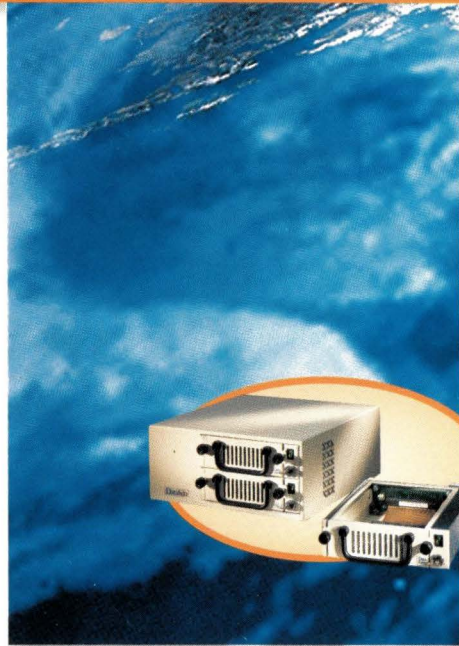

Kingston Technology Company, 17600 Newhope Street, Fountain Valley, CA 92708, USA (714) 438-1850, Fax (714) 438-1847. © 1999 Kingston Technology Company. All rights reserved. All trademarks and registered trademarks are the property of their respective owners.



YOU CAN CONSOLIDATE  
MANAGEMENT OF YOUR SERVERS.

YOU CAN REDUCE SYSTEM  
DOWNTIME.



YOU CAN HAVE  
DINNER WITH YOUR FAMILY.

Lightwave Communications console management solutions for Unix, PC's and Serial devices fit your needs with a complete line of video, keyboard/mouse, serial (TTY) switches and fiber optic extender kits.

Lightwave's ConsoleServer 3200, ServerSwitch, PC ServerSwitch Plus and SystemConsoleSwitch reclaim valuable server room space and eliminate unneeded peripherals. Remote access puts server control at your fingertips and our audit trail, up to 64K per port, help reduce downtime and diagnose problems quickly. In short, our systems help you reclaim your space, reclaim your time, and most of all, reclaim your life!



261 Pepe's Farm Road, Milford, CT 06460  
203 878-9838 • 800-871-9838 • Fax: 203-874-0157

Europe: +49 893 063 810  
Asia Pacific: +61 396 527 515

Email: [sales@lightwavecom.com](mailto:sales@lightwavecom.com)  
World Wide Web: [www.lightwavecom.com](http://www.lightwavecom.com)

Email: [office@lightwave.de](mailto:office@lightwave.de)  
Email: [sales@lightwavecom.com.au](mailto:sales@lightwavecom.com.au)

Circle No. 2





# Formerly SunExpert Magazine Server/Workstation EXPERT

Solutions  
for hands-on  
IT managers

World Wide Web  
<http://sw.expert.com>

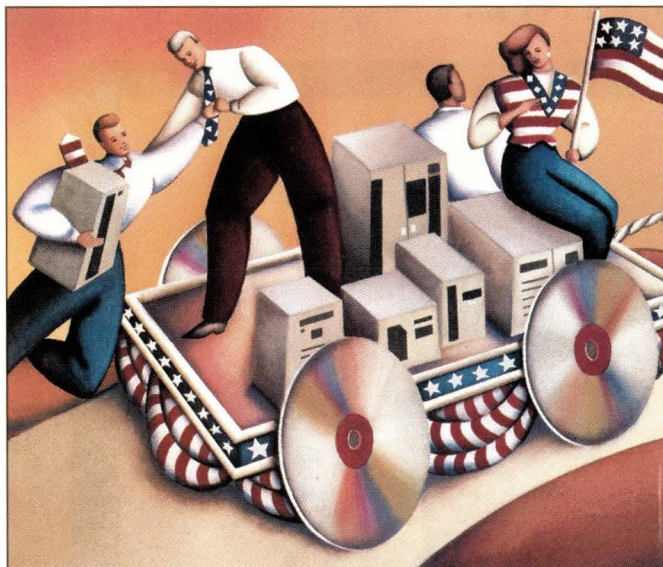

COVER BY REBECCA RUEGGER

## CONTENTS

### Feature

#### 46 Backup Pros Jump on the SANwagon

It seems almost every backup vendor is hard at work testing the latest storage area network configuration. Is it time you jumped on the SAN bandwagon?

by Alexandra Barrett

### Survey

#### 54 Networkable UPS Devices

A sampling of uninterruptible power supply (UPS) devices currently on the market.

Compiled by Maureen McKeon

### News

#### 6 Includes: Linux Tower of Babel?, HotSpot: How Hot is it?, Artecon Boxed in, Setting Standards.

## Columns

#### 18 Ask Mr. Protocol by Michael O'Brien Doom and Death

The backlash from the Columbine tragedy places the Internet in the media spotlight.

#### 23 UNIX Basics by Peter Collinson Just what is that File?

There seems to be an increasing number of commands and files on UNIX systems that are unexplained and mysterious, and lacking associated documentation.

#### 30 NTegration by Aileen Frisch More Useful Tools

This month, we'll consider Windows NT tools beyond what Microsoft provides, including both free software and commercial products.

#### 38 Work by Jeffreys Copeland and Haemer I18N, Part 2

The Jeffs wrap up their two-part discussion on internationalization with a look at wide-character strings.

#### 42 Java Class by Jim Frost A Tangled Skein

It's time to look at the Java threading model and build some objects that are useful in a multithreaded environment.







# Product Review

## 59 FlashDisk: No Flash in the Pan

Winchester Systems' FlashDisk could quite possibly be the 'world's fastest RAID array,' and its documentation isn't bad either.

by Mark Petrie

### SUPPLEMENT

# WebServer

For Managers of World Wide Web Sites

M A G A Z I N E

Visit Our Web Site at  
<http://webserver.cpg.com>

## 62 Content Management: Galloping Off in All Directions

by Michael Jay Tucker

In this information-based economy, companies are being asked to pump increasingly complex information around increasingly sophisticated networks, so much so, it's becoming increasingly difficult to manage all that content.

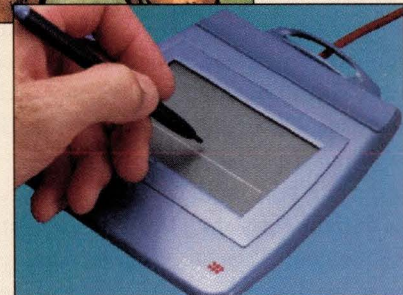

## 66 URL/New Products

New products, services and resources for the World Wide Web market.

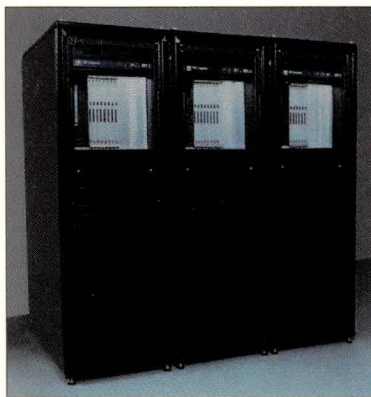

Page 70

## Departments

- 4 Editorial
- 40 Reader Feedback
- 70 New Products
- 76 Server/Workstation Marketplace
- 88 Advertisers' Index

### BONUS TO ADVERTISERS OF THE AUGUST ISSUE:

- **Siggraph 99**  
Los Angeles, CA
- **ICON/eBusiness World**  
San Jose, CA

### BONUS TO ADVERTISERS OF THE SEPTEMBER ISSUE:

- **Internet Commerce Expo**  
San Francisco, CA

SERVER/WORKSTATION EXPERT Magazine (ISSN 1524-4849) is published monthly by Computer Publishing Group, 1340 Centre St., Newton Center, MA 02459. Telephone (617) 641-9101. Periodicals Postage Rates paid at Boston, MA, and at additional mailing offices. Posted under Canadian IPM #0235873. This publication is free to qualified subscribers as determined by the publisher. Subscription rates are \$60 per year in the United States, and \$95 (surface mail) and \$150 (air mail) outside the United States. Subscription requests can be sent to Circulation Department, SERVER/WORKSTATION EXPERT Magazine, 1340 Centre St., Newton Center, MA 02459, or electronically mailed to [circ@cpg.com](mailto:circ@cpg.com).

POSTMASTER, please send all address changes to SERVER/WORKSTATION EXPERT Magazine, Circulation Department, 1340 Centre St., Newton Center, MA 02459. Please allow 6-8 weeks for change of address. Include your old address as well as new—enclosing, if possible, an address label from a recent issue. All rights reserved. © Copyright 1999, Computer Publishing Group. No part of this publication may be transmitted or reproduced in any form by any means without permission in writing from the publisher.

Material for publication should be sent to the attention of Doug Pryor at the above address or electronically mailed to [dpryor@cpg.com](mailto:dpryor@cpg.com). Letters sent to the publication become the property of the publication and are assumed to be intended for publication and may be used so. All information herein is believed to be accurate to the best of our ability.



# EDITORIAL

dpryor@cpg.com

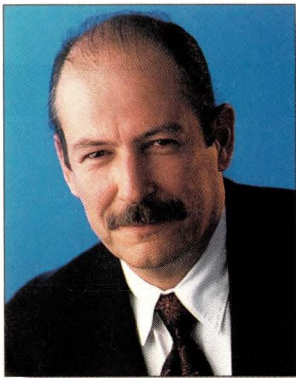

## Blasts from the Past

**D**id you see something in past issues of *SW Expert* that caught your attention? Did you think, "I'll look at that more closely when I have time"? Then you forgot which issue it was. Well,

now there's a way to jog your memory. We have indexed and archived at least two years worth of *SW Expert*. If you go to <http://www.sw.expert.com>, and follow the links, you'll be able to use our keyword search to find that which was lost or only partially remembered. If, for example, you look for "network attached storage," you get in return a list of current and past articles in *SW Expert* relevant to that topic. Also, we have indexed the complete set of RFCs. Please use this service. We do.

The files you'll find are in Portable Document Format (PDF). We chose this format to protect the design of our magazine. We are very proud of our look and the attention to illustration our art department displays every month. With PDF, we can show you exactly what appeared in the hard copy of each issue. We think it's worth getting the Adobe Acrobat reader just to see what the artists have come up with.

And while we're on the subject of storage and networks, you'll want to look at this month's cover story by Alexandra Barrett, called "Backup Pros Jump on the SANwagon," Page 46. While storage area networks are getting all the ink in the press, we thought it might be a good idea to investigate how all these new SANs are getting backed up. That's the topic of Alex's feature. She discovered that almost every backup vendor is hard at work testing the latest SAN configuration. The fact that SANs reportedly allow you to effortlessly add storage capacity to the data center and manage it with unprecedented ease, sends ripples of panic through all those hardy souls charged with maintaining the backup regime for these systems. Data, data everywhere and all the sysadmins did shrink. So too have backup windows. But take heart. Alex says, "While adding more storage certainly can't help a backup predicament any, a SAN, implemented correctly, can actually go a long way to easing your backup woes. In a few cases, SANs can actually decrease the amount of time it takes you to do backup. And, in most cases, they can actually save you money."

So remember "save you money," and you'll be able to track down this feature in our archives in the months to come.

*Doug Pryor*

# S/W EXPERT

July 1999

Vol. 10 No. 7

<b>Publisher</b>	S. HENRY SACKS shs@cpg.com
<b>Editor-in-Chief</b>	DOUGLAS PRYOR dpryor@cpg.com
<b>Managing Editor</b>	LISA BUCHER lisab@cpg.com
<b>Technical Editor</b>	IAN WESTMACOTT ianw@cpg.com
<b>Contributing Editor</b>	SIMSON L. GARFINKEL
<b>Staff Editors</b>	PATRICK T. COLEMAN pat@cpg.com
	SUZANNE HILDRETH sjh@cpg.com
<b>Production Editor</b>	MICHAEL LETTS mletts@cpg.com
<b>Art/Production Director</b>	JOHN W. KELLEY JR. jwk@cpg.com
<b>Senior Designer</b>	BRAD DILLMAN bdillman@cpg.com
<b>Production Assistant</b>	CAMILLE LORENZETTI camille@cpg.com
<b>Circulation Director</b>	DEBORAH MOORE dm@cpg.com
<b>Promotion Manager</b>	MELANIE DECAROLIS melanie@cpg.com
<b>Accounting Manager</b>	ROBIN YEARWOOD robin@cpg.com
<b>Office Manager</b>	TINA JACKSON jamal@cpg.com
<b>Business Manager</b>	SUSAN R. SACKS srs@cpg.com

### World Wide Web

<http://www.cpg.com>

### EDITORIAL OFFICES

1340 Centre St.  
Newton Center, MA 02459  
(617) 641-9101



Printed in USA



# A Powerful Combination



Rave Systems RackMount-2UAXi: a rackmount server with performance power.



Mammoth: Exabyte's most powerful tape drive is a recognized leader in performance speed and reliability.



Mammoth-LT: Rugged affordable tape drive with high performance and reliability.

What a combination. Rave Systems and Exabyte. When you're looking for exceptional performance and reliability in data management and storage, take a look at the combination of Rave Systems AXi server and Exabyte's Mammoth tape drives. Our Rave Systems AXi provide you a powerful system designed for today's most compute-intensive applications. Rave Systems AXi feature an original Sun Microsystems's Ultra™ AXi motherboard and UltraSPARC™ -III processors integrated into a rack-mountable or a mid-tower chassis with 300 Watt power supply and PCI slots. Each Rave Systems allow for flexible configurations to meet every customer's unique needs. With Exabyte's Mammoth-LT or Mammoth tape drives, featuring fast data transfer rates of up to 6MB per second and read-while-write capabilities, you have reliability and performance in data storage. Rave Computer, a leading Sun Microsystems® authorized value-added system integrator is proud to offer Exabyte's tape drives in conjunction with its SPARC® solutions.



Eliant 820 - entry level affordable tape backup with fast data transfer rate.

*Exabyte products, just like Rave Systems allow for easy migration and integration.*

Trade in your old tape drives, and stackers for new high performance Exabyte drives and save! For more details, call Rave at 1-800-966-7283

For more information about Rave Computer Association, Inc., Rave Systems and other solutions, call 1-800-966-7283 or visit our web site at [www.rave.net](http://www.rave.net)



**Rave Computer Association, Inc.**  
**1-800-966-7283**

36960 Metro Court, Sterling Heights, Michigan 48312

Fax: (810) 939-7431 E-mail: [info@rave.com](mailto:info@rave.com)

Leasing Available-call 1-800-500-7283



Exabyte is a registered trademark. Sun, Sun Microsystems, and the Sun logo are trademark or registered trademarks of Sun Microsystems, Inc., in the United States or other countries. All other trademarks are the property of their respective companies. All SPARC trademarks are used under license and are trademarks or registered trademarks of SPARC International, Inc. in the United States and other countries. Products bearing SPARC trademarks are based upon an architecture developed by Sun Microsystems, Inc. All other products or service names mentioned herein are trademarks of their respective owners.



# Server/Workstation NEWS

Visit Our Web Site <http://sw.expert.com>

## Linux Tower of Babel?

Shopping for a Linux distribution to download? Don't expect to accomplish the task over your lunch break. Choosing between the multiple versions of this open-source operating system isn't as simple as merely clicking on a freeware site these days. There are dozens—perhaps hundreds—of versions of the platform, available in both commercial and freeware form.

This diversity may be fine for technical users who like having plenty of options and have no qualms about navigating the subtle differences among the various flavors of Linux. But it's likely to become a bit of a headache for software and hardware vendors, as well as corporate customers who don't want to have to kick the tires on a dozen-odd versions of an operating system. While all distributions aim to support the most recent Linux kernel—the basic core of the operating system that is licensed by the GNU Project and the Free Software Foundation (<http://www.gnu.org>)—they may differ in a number of other ways, including administrative tools, user interfaces, configuration processes and libraries.

"There are many distributions, some free, some you have to pay for, some of which involve all open-source code, some involving closed-source code as well, and the only thing they really all have in common is the use of the Linux kernel itself," said Tony Iams, research director for systems software at UNIX research firm D.H. Brown & Associates Inc., Port Chester, NY, during a recent presentation on D.H. Brown's report, "Linux: How Good is it?"

That's why many in the Linux community are initiating efforts to ensure a basic level of compatibility between the

various distributions and to ensure that products claiming to support specific Linux platforms actually do so.

Most recently, KeyLabs Inc., a testing and certification company based in Lindon, UT, introduced a Linux certification program for hardware vendors. Pete Nelson, program manager for KeyLabs, says the certification arose from demand from both vendors and customers. "The hardware vendors didn't want to have to send a box to each, individual distribution vendor to



ROBERT BURGER

pass their certification. They'd rather have it done in one place. We also saw a need on the corporate side from business leaders, IS managers and others who want to have a 'seal of approval' on a product before they purchase it. They don't like to buy untested products," Nelson says.

The company tests products from four leading distributors—Red Hat Linux from Red Hat Software Inc., Research Triangle Park, NC, OpenLinux from Caldera Systems Inc., Orem, UT, Turbo Linux from Pacific HiTech Inc., Oakland, CA, and SuSE Linux by

German firm S.u.S.E. GmbH. Other distributions may be added in the future. Nelson says that, while KeyLabs is starting its certification with servers and workstations, the company plans to expand into peripheral devices and, eventually, into software applications.

Other members of the Linux community are working to iron out differences in how applications are supported on the various distributions. For example, a group of 14 software developers and distribution vendors, including Red Hat, Caldera, Pacific HiTech and S.u.S.E., are collaborating on a Linux Standards Base (LSB) in an attempt to develop a standard specification for all Linux development, as well as a test suite and sample implementation (<http://www.linuxbase.org>).

"About a year or so ago, we realized that with all the different distributions, there was some potential that the Linux space might split in the same way the UNIX space did," says Jon Hall, senior leader of the UNIX Software Group at Compaq Computer Corp., Houston, TX, and executive director of Linux International (<http://www.li.org>), a not-for-profit organization dedicated to encouraging Linux development. "Although Linux vendors do use the same libraries and kernel, there are sometimes glitches in the libraries that cause a break in binary compatibility. Also, there are lots of applications in UNIX which require more than just the libraries and kernel to be specified—things like positions of the password file, syntax of the password file, how device names are designated, things like that. All of those need to be spelled out in a binary standard that an ISV can program to. That's what the LSB is about."

Of course, multiple versions of Linux are not, in and of themselves, a



# Sun Ultra 2 User?

Need more performance? .....Absolutely.  
Budget constrained? .....Who's not.  
Thinking of going to Pentium III? .....Don't!

## Try this...

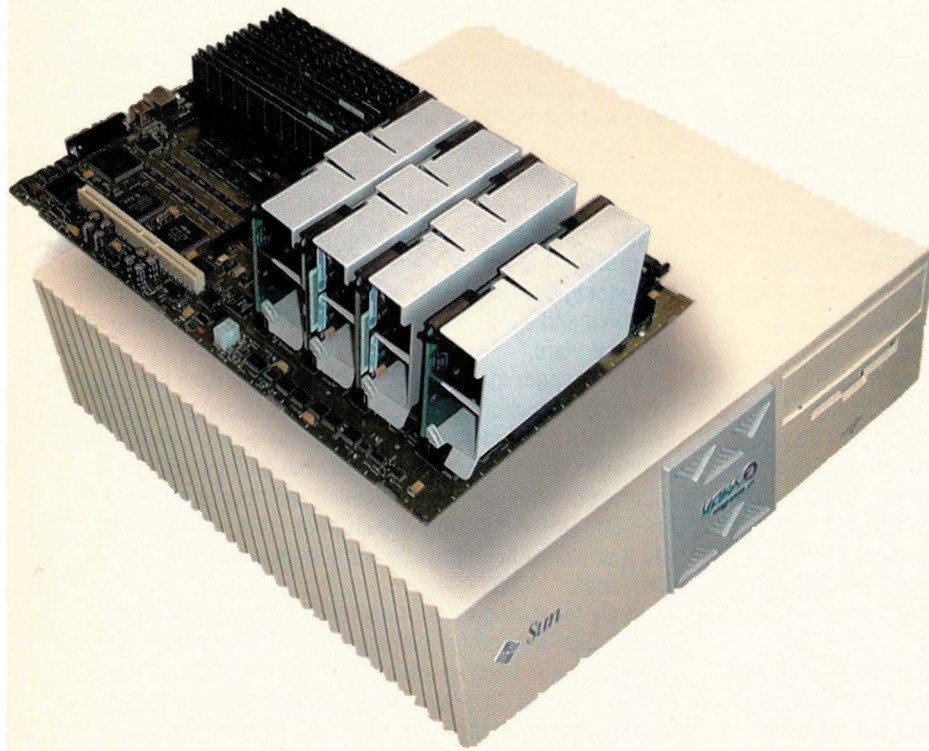

Recycle your Sun Ultra 2 motherboard by upgrading to a CycleQUAD motherboard

Circle No. 4

Four Ultra 2  
450 MHz  
processors

3 GB memory  
capacity

Standard Ultra 2  
footprint

Fast  
Inexpensive  
Fully compatible  
Fully guaranteed

# [www.cycleecc.com](http://www.cycleecc.com)



©1999 Cycle Computer Corporation. [sales@cycleecc.com](mailto:sales@cycleecc.com)

Cycle is fully authorized by Sun as a licensed SPARC design and manufacturing company.  
Sun, Ultra, and SPARC are trademarks of Sun Microsystems. All other trademarks are the property of their respective holders.



bad thing. Many in the Linux community consider it a mark of healthy competition and innovation. "Think how good the Windows environment might be if there had been four or five companies with Microsoft's code competing against each other to make it better," says Art Tyde, executive vice president and cofounder of Linux training and certification firm Linuxcare Inc., San Francisco, CA. Different types of users may find one or other of the Linux distributions better suited to their needs; some distributions focus on optimizing scientific applications, for instance, while others offer foreign language support for Japanese or Korean users. And,

of course, many of the versions are aimed at different hardware platforms.

But differences in basic functionality are likely to hamper, not help, end-user and ISV adoption of the Linux platform, experts say. As far as software vendors are concerned, standardization is likely to encourage more development of Linux applications. "For software vendors and companies like ours, which support multiple distributions, it makes it a lot easier if everyone is following a standard," Tyde says.

For customers, standardization of things such as the configuration process and user interface is likely to be more important and may dictate how quickly

Linux gains acceptance with mainstream corporate users. "Linux has a couple of major [user interface] alternatives and a couple of minor ones, and some sort of convergence over time is going to be critical on the desktop for gaining any additional momentum," says Greg Weiss, analyst for D.H. Brown.—*sjh*

## HotSpot: How Hot is it?

At last, developers of server-side Java applications are getting a chance to test-drive Sun Microsystems Inc.'s long-awaited HotSpot Java Performance

### Artecon Boxed in

**T**he storage market continues to see consolidation of its smaller players. At the end of April, Box Hill Systems Corp., New York, NY, and Artecon Inc., Carlsbad, CA, announced a definitive agreement to merge. The resulting company will operate under the Box Hill moniker until a new name is approved.

"The reason for the merger is that RAID is becoming a commodity product. Margins are dropping and it's very difficult for smaller players to continue to grow," says Aaron Shatz, research analyst at International Data Corp. (IDC), Framingham, MA. "We've found that larger players take market share from smaller players. So a consolidation of smaller players is inevitable. This merger makes [Box Hill and Artecon] the biggest of the smaller third-party players."

Shatz defines small third-party players as RAID vendors that do not sell to OEMs and are not EMC Corp., Hopkinton, MA. Typically, they generate less than \$100 million in revenue per year from storage products. Such companies include Ciprico Inc., Plymouth, MN, ECCS Inc., Tinton Falls, NJ, nStor Corporation Inc., Lake Mary, FL, and Storage Computer Corp., Nashua, NH.

Box Hill's acquisition of Artecon is the third storage acquisition to be announced this year. The first was in January, when Sun Microsystems Inc. purchased Maxstrat Corp., Milpitas, CA. That was followed in March by an announcement that nStor had acquired a controlling interest in Andataco Inc., San Diego, CA. "There are just scores of these smaller companies that do maybe a \$100 million in revenue a year," says Roger Cox, chief analyst at research firm Dataquest, San Jose, CA. "They can't get any bigger unless they consolidate by merging and leveraging the resources you can get by merging."

By merging, Box Hill and Artecon can combine their efforts in developing hardware and software for the emerging storage area network (SAN) market, as well as benefit from the unique customer base each company brings to the table. "This really gives us critical mass," says Jim Lambert, chief executive officer (CEO) and founder of Artecon, and future co-CEO of the merged company. "Our salesforce is much bigger. Our cus-

tomers support and professional organization is a lot stronger. We see that software and professional services are going to be important for the future with storage area networks."

Dataquest's Cox agrees this is necessary to compete in the SAN market, "which is the market of the next decade," he says.

From Box Hill and Artecon's perspective, they hope the merger will position the new company as a leading vendor in the growing market. "We are and will become an Internet and SAN storage powerhouse," says Carol Turchin, executive vice president and cofounder of Box Hill. "We will get stronger as we go forward."

One strength may grow out of the merger: each company has a unique customer base. Box Hill has strong ties to the financial and communications companies on the East Coast, while Artecon has a significant presence on the West Coast with telecommunications companies and Internet service providers (ISPs). "Customer-base-wise it's a really good fit and it will allow them to cut costs and grow margins," IDC's Shatz says.

While the third-party storage vendor space lost a player with the Box Hill and Artecon merger, the high-end hardware and software storage space added a new competitor. In May, Hewlett-Packard Co., Palo Alto, CA, launched a new line of storage products dubbed "stress-free." The new line will compete directly with EMC's products. Previously, HP was a reseller of EMC products and reportedly accounted for 13% of EMC's revenue in 1998. Now, HP has licensed disk arrays from Hitachi Data Systems Inc. and will offer the MC256 disk array. The company also announced the Switch F16, a 16-port Fibre Channel switch, and SureStore E enterprise storage systems and management software.

Analysts predict that HP's foray into the high end against its old partner will be good news for customers in the long run. "It creates more competition for the end user," says Dataquest's Cox. "They're going to get better pricing and better value in terms of products and support. Now there are two companies competing for the same business, whereas before EMC and HP would work together to get the business."—*ptc*



# SAVE DATA!

## Get on the right track with AMASS

Relax. There's no need to panic. Making the right choice is easy with AMASS® Online Software. AMASS is engineered so you can save data by extending storage capacity using an automated library. This process is transparent and appears as a single drive letter on the user's system. Because AMASS provides infinite storage, not just archiving, you can save it all.

### Help Save Data!

Visit [www.adic.com/savedata1](http://www.adic.com/savedata1) to learn more and register to win a flight bag to store your stuff.

**adic**

1 800 653 6277

Help! My name is Data.



Engine, the Java compiler touted as the answer to server-side Java performance woes. In April, Sun posted the first completed version of HotSpot for Windows to its Web site (<http://java.sun.com/products/hotspot>)—almost two years since it was announced and more than one year after it was originally scheduled to be finished. Sun also released a SPARC version of HotSpot in June for use by Sun licensees.

HotSpot features faster garbage collection, thread synchronization and an approach called “adaptive optimization,” which means that the most performance-critical parts of an application are compiled first, while the rest of the application is left in byte code for on-the-fly interpretation. The compiler profiles the application to identify, and then optimize for, performance “hot spots,” or bottlenecks in the code, rather than attempting to compile everything it encounters, which is how traditional just-in-time (JIT) compilers work. According to Larry Abrahams, director of core Java 2 development at Sun, HotSpot offers server-side performance gains of 100% over Sun’s Java Development Kit (JDK) 1.1, which uses a combination of Sun’s classic Java Virtual Machine (JVM) and a JIT compiler from Cupertino, CA-based Symantec Corp.

HotSpot licensees and users report varying degrees of improvement: Marc San Souci, chief technology officer of GemStone Systems Inc., Beaverton, OR, which is licensing HotSpot for use in its GemStoneJ application server, reports substantial gains in performance. “Compared to previous revs of the Java 2 Virtual Machine, we’re seeing a two-times improvement for most routine operations and five-times for more specialized, computational-type applications. One thing we’ve found is that the HotSpot garbage collector does a better job of keeping up with a VM that has a lot of concurrent activity and a lot of threads, which is typical of server-based software,” San Souci says.

Lowell Kaplan, senior consultant for RandomWalk Computing Inc., a Java consulting firm based in New York, NY, agrees that HotSpot produces noticeable improvements in response

time over the JDK 1.2 JVM and JIT, although he hasn’t done any benchmarking. “I think it’s lived up to its expectations in terms of performance,” says Kaplan, who nonetheless wouldn’t mind seeing even more performance increases in the future. “Any more drops they can squeeze out of it [would be good],” he says.

On the other hand, Hewlett-Packard Co., Palo Alto, CA, which licensed HotSpot and is now putting the finishing touches on a HotSpot port to HP-UX, reports performance gains of closer

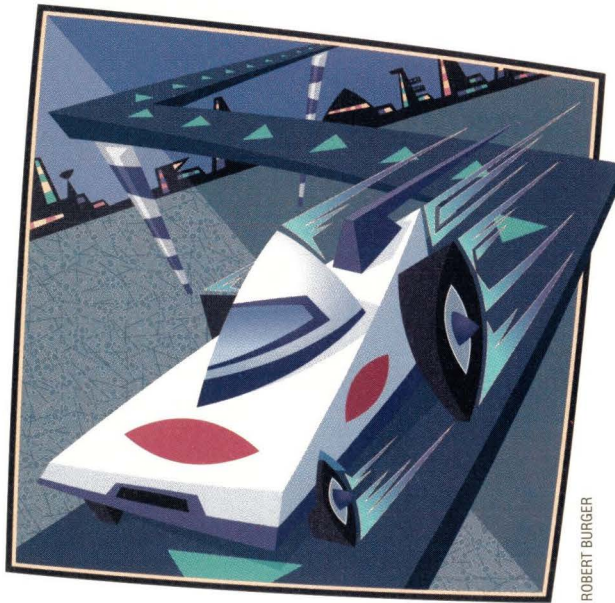

ROBERT BURGER

to 30%. “A couple of years ago, when Sun started talking about HotSpot, they talked about a fairly revolutionary, order-of-magnitude improvement and that hasn’t really materialized with this current version of HotSpot,” says Susan Henson, enterprise Java program manager for HP. However, Henson says the next version of HotSpot, due out later this summer in early access form, is likely to further improve performance. “Sun probably had to leave some performance on the table [with this version] and will go back and get that in the next revision.”

Sun’s Abrahams says the next version of HotSpot will indeed work on increasing performance and will probably add another 30% improvement to the performance engine’s current speeds. Where HotSpot is most likely to make a difference is in long-running, server-side appli-

cations. “HotSpot does a great job of speeding up byte code by compiling into native code and that will help programs that are heavily weighted toward byte code execution, which typically means server programs,” Abrahams says.

Sun will need that extra margin to stay ahead of the competition. In the May VolanoMark ratings (<http://www.volano.com/report.html>)—a benchmark for Java server applications on the Intel Corp. platform conducted by Volano LLC, a Java chat server vendor based in Seattle, WA—three compilers

placed higher than HotSpot in terms of performance. In that test, HotSpot came in fourth behind Tower Technology Corp.’s TowerJ 3.0 for Linux and IBM Corp.’s JDK 1.1.7 for OS/2 and JDK 1.1.7 for Windows.

In fact, Sun has more competition these days in the compiler arena than it did when it first announced HotSpot two years ago. To some degree, that’s the result of Sun’s delay in getting the HotSpot technology into the market. Tim Thatcher,

program director of marketing for Java at IBM, says IBM decided to develop its own JIT for Windows only after deciding that Sun wasn’t moving fast enough: “We were concerned that Java was not evolving to the extent it needed to on the Windows platform,” Thatcher says. “We felt it needed a top-notch solution on the Windows platform. Prior to HotSpot, we didn’t feel Sun was doing an adequate job of serving the needs of that segment of the marketplace.”

Sun also has competition from the makers of native compilers, which optimize performance by compiling Java byte code down to native binaries rather than by doing on-the-fly compilation. “TowerJ can provide better performance with fewer hardware resources than HotSpot will ever be able to,” says Martin Cloutier, chief operating officer of Tower Technology. “The reason is



# ANDATACO's GigaRAID/AA

## THE PATH TO DATA AVAILABILITY

Start with 9, 18 or 36GB IBM disk drives.

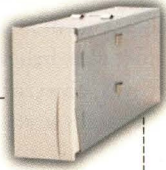

Featuring ANDATACO's award winning ESP enclosure technology.

Dual Active/Active controllers with automatic failover.

SAN-Ready™ with fibre connectivity for complete investment protection.

IEEE classified Disaster Tolerant Disk System Plus (DTDS+) for high availability.

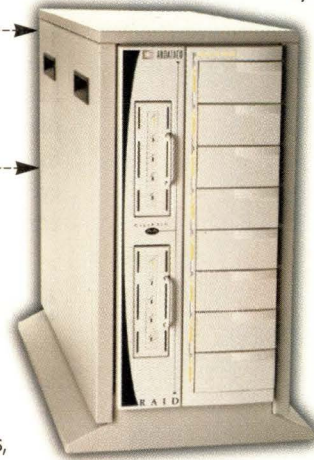

Add or grow volumes while still sending I/O from the host.

RAID levels 0, 1, 0/1, 3, 5, and JBOD with global hot spare disk drives for an automatic rebuild.

128MB of mirrored cache memory per controller pair for lightning-quick response to read and write requests.

Designed for optimal performance and fault tolerance in Sun-Solaris®, SGI®, HP® and Windows NT environments.

Hot swappable drives, controllers, power supplies and fans.

Battery backup protects data in cache during power or system failures.

User-Definable rebuild priority to suit your specific need for fault tolerance versus I/O performance.

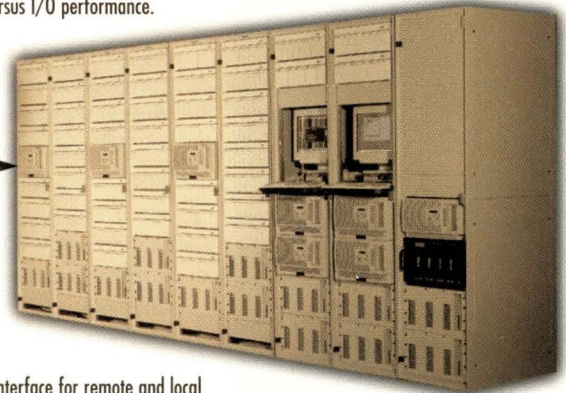
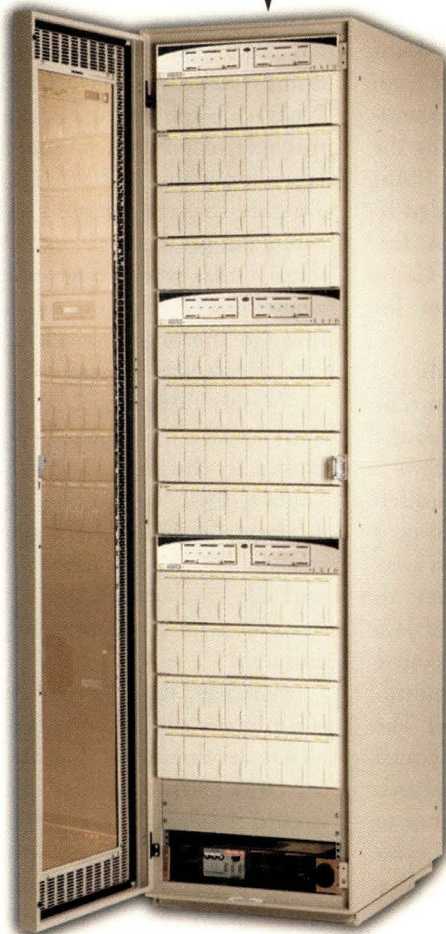

User-friendly GUI interface for remote and local proactive storage and asset management via Web Storage Manager (WSM 2.0).

Expandable up to 60 IBM drives (7.16TB) behind a single controller for capacity solutions.

Up to 10 multi-platform host connections and up to 3.6TB of storage in a single data center.



Call ANDATACO 1.800.453-2499

Visit Our Web Site at [www.andataco.com](http://www.andataco.com)

©1999 ANDATACO, Inc. All rights are reserved. GigaRAID is a trademark of ANDATACO. All other trademarks, registered trademarks, tradenames, and service marks are the respective properties of their holders.

 **ANDATACO**  
The Storage Experts



# TIME IS RUNNING OUT

Get the BridgePoint Y2K Survival Kit for your Sparcstation 5, 10, 20 or 600 MP

# NOW!



Images copyright © 1998 PhotoDisc, Inc.

## BridgePoint

Technical Manufacturing  
[www.bridgept.com](http://www.bridgept.com)

U.S. & Canada International

**Marco** Eclipse  
International Inc.

800-621-4668 +44-1707-333-960

[www.marco-international.com](http://www.marco-international.com)  
[sales@marco-international.com](mailto:sales@marco-international.com)

[caroli@attmail.com](mailto:caroli@attmail.com)

Circle No. 7

that we do all of this optimization offline from the production machines, so we create a very highly optimized, compact, self-contained native executable, which runs very fast on the machines we target." Of course, the resulting native binaries don't have the advantage of cross-platform portability provided by pure Java byte code.

Sun won't say how many vendors have lined up to license HotSpot, but says that a "sizeable number" of vendors are porting it to other platforms. And Sun's Abrahams says the technology will help eliminate any reluctance on the part of corporate customers to use Java for server-side applications. "If there ever was a barrier to adoption, HotSpot removes it once and for all."—*sjb*

## Setting Standards

Sun Microsystems Inc. has altered its course for standardizing Java 2. Sun, the company responsible for developing the Java language, originally planned to submit the specification to Joint Technical Committee 1 (JTC1), an International Organization for Standardization (ISO) committee, using the Publicly Available Specification (PAS) process. Instead, Sun has decided to submit the technology to ECMA, formerly known as the European Computer Manufacturers Association, for formal standardization.

For some in the industry, this is a good news and bad news situation. The good news is Sun hopes to make the technology a standard. The bad news is some observers believe the sudden change could give Sun unfettered control over that standard. "Sun's shift away from using the ISO PAS process to achieve de jure standardization of Java has removed the element of recourse and credibility that ISO was providing," says Rich Ross, president of The Java Lobby, a nonprofit group dedicated to the advancement of Java standards and software. "ISO gave confidence to developers that Sun couldn't take this thing and be a runaway train with it."

Sun appears to have made the move to ECMA because of a recent change made by JTC1 regarding the maintenance of standards. According to

JTC1's new procedures, modifications and maintenance of standards must come from a working group. Some Java followers believe Sun wants to maintain total control of Java even after it becomes a standard and that perhaps ECMA is a way for the company to accomplish this.

### JAVA LOBBY POLL RESULTS

Members of The Java Lobby rated their impressions of the following statement:

"Sun's process for Java is open and fair."

Here are the results:

1. Strongly disagree 52 (9%)
2. Disagree 81 (14%)
3. Neither disagree nor agree 103 (18%)
4. Agree 202 (36%)
5. Strongly agree 129 (23%)

"Sun already has what they consider to be a very efficient and inclusive and fast process for evolving the Java technology, called the Java Community Process," says David Harrah, group manager of public relations for Sun's JavaSoft division. "All the Java licensees are able to participate. Those companies can get together, come up with a solution that everyone agrees upon. We would have to scrap that process or go through the process twice if we had continued going through PAS."

"With all due respect to ECMA, I don't believe it is equal in stature or power to the ISO," says The Java Lobby's Ross. "I think this creates the question, 'Is ECMA in a position to provide any sense of security that Sun can't take Java at some future time and run away with it in some self-interested direction?'"

Moreover, supporters of Sun's Java efforts aren't sure what to make of the recent development. A spokeswoman for IBM Corp. provided a carefully worded response to Sun's submission to ECMA that was neither an endorsement nor a denouncement of the move: "IBM thinks that mature portions of Java should be managed and maintained by a standards organization and they are currently evaluating Sun's



# Fifteen top OEMs choose Tecmar Travan NS. Find out why...

"NCR's use of the Tecmar NS tape technology underscores the company's **commitment to integrate** the best-of-breed technologies into our industry-specific solutions. With its unique server class features, the Tecmar NS20 technology made a significant and compelling argument for its selection."

Gary Horning, Vice President  
Global Alliance Partners  
NCR - Computer Systems

"In addition to its **value-added benefits** and patented reliability features, Acer selected Tecmar's NS20 for its innovative NSync soft-load design that set it apart from its competitors."

Barry Huang  
Director of Product Management  
Acer, Inc.

"Tecmar's advanced NS20 technology meshes nicely with the security and **high-reliability features** of our Magnia series, which are designed to maximize system network uptime."

Bill Greenlund  
Senior Director of Marketing  
Toshiba - TAIS CSD

"Tecmar's NS20 adheres to Motorola's high reliability requirements and was chosen for its **excellent performance, dependability and superior media handling** capabilities."

Tim Trautman  
Product Manager for Peripheral Devices  
Motorola Computer Group  
Telecommunications Business Unit

Tecmar has rapidly become the dominant leader of Travan NS tape backup solutions for the emerging NT marketplace. The Tecmar Travan NS20 is the only in-form factor drive that offers NSync -- integrated precision tape loading. It also offers 20GB capacity at 2MB per second transfer rate, read-while-write recording, hardware data compression, SCSI and ATAPI interfaces, plug-and-play compatibility, and much more. TRAVAN 



1900 Pike Road, Building E • Longmont, Colorado 80501  
303-682-3700 • Fax: 303-776-1698

[www.tecmar.com](http://www.tecmar.com)



Qualify for a Test Drive. For more information call 1-800-4-BACKUP.

Circle No. 8



ECMA proposals," she said. Quickly adding, "IBM really doesn't have a feel on the proposal and the differences between ISO and ECMA."

ECMA has to officially accept the process of standardizing Java 2. If it does, the group will then lay down rules for how that process will work. Once the specification is approved, ECMA will submit it back to JTC1 to receive ISO approval. At that point, because ECMA is a Class A ISO liaison, Java would not be required to go through PAS, avoiding the whole issue of being maintained by a working group. Java 2 could be forwarded to ISO for fast-track approval as an international standard.

To date, most Java supporters are happy with Sun's efforts. In fact, while Ross personally is not happy about the move to ECMA, the majority of his organization's members are happy with Sun's handling of Java. In May, members of The Java Lobby were asked to rate their opinion on the following statement: "Sun's process for Java is open and

fair." The members were given five options: strongly disagree, disagree, neither disagree nor agree, agree and strongly agree. Out of 567 respondents, 59% agreed or strongly agreed with that statement, indicating support for Sun's management of Java. Only 9% strongly disagreed with the statement.—*ptc*

## NCs See Slow but Steady Growth

The Network Computer (NC) industry is expected to maintain a healthy rate of growth in the coming years, according to a survey by International Data Corp. (IDC), Framingham, MA—and it may have Microsoft Corp. to thank for it.

Worldwide shipments of enterprise thin clients are expected to jump 87% from 369,000 in 1998 to 1.2 million in 1999 and 6 million in 2003. This growth can be attributed to an increase in demand for Windows-based terminals spurred, in part, by the release last year of Microsoft's Windows Terminal Server

Edition (TSE) software and the subsequent TSE price cuts announced in January. In contrast, Java-based NCs are expected to grow more slowly.

"By far, as we move forward into the forecast, the majority [of thin clients shipped] will be Windows-based terminals," says Eileen O'Brien, director of NC research for IDC. "Of the 6 million units to ship in 2003, approximately 4.2 million will be Windows-based and 1.8 million will be [Java-based] Network Computers." She estimates the Windows-based terminal market will have a compound annual growth rate (in units shipped) of 80.7% from 1999 to 2003. The Java-based NC market is expected to grow 58.1% during the same period.

However, Howie Hunger, director of channels and marketing for Network Stations at IBM Corp., reports that IBM is seeing healthy sales of both its Windows-based and Java-based NCs. IBM, which sold 81,000 of its Network Station NCs in 1998, according to IDC, makes three different versions of the Network Station for Windows-based computing, Java-based computing and Internet access or terminal emulation. The Network Station 1000, specifically aimed at Java computing, accounted for 35% of sales, according to Hunger. "That states that either customers are using those devices for Java or they see a need for Java in the future," he says. However, Hunger estimates that 50% of the total units sold were used for Windows access, indicating many customers may have multiple uses for their NCs.

Hunger says the market for NCs is shaping up to be a fairly diverse one, with customers putting NCs to work in various applications from terminal emulation to client-side Java processing. "We take a very broad view of the thin-client marketplace from Windows access all the way up through Java. That's why we've had good success," Hunger says.

IBM, which has landed a number of major customers for its NCs in the past year, came in second in number of shipments only to Wyse Technology Inc., San Jose, CA, which sold 117,000 of its Windows-based terminals in 1998. Sun Microsystems Inc. sold just 10,000 of its JavaStation NCs last year, according to IDC estimates.—*sjh*

## Aim High With IntraServer SCSI & Network I/O Peripherals For Solaris SPARC and Solaris x86 Systems!

IntraServer offers a complete line of PCI I/O Peripherals, including Ultra Wide SCSI, Ultra2/LVD SCSI, 10/100 Ethernet and CompactPCI adapters. If you're looking for quality products, high performance, and solid support call IntraServer or one of our resellers.

Seven October Hill Road  
Holliston, MA 01746 U.S.A.

Please call us:  
Toll-free: 888.429.0425  
Phone: 508.429.0425  
Fax: 508.429.0430 In the U.S.

**IntraServer**  
TECHNOLOGY, INC.

Website: [www.intraserver.com](http://www.intraserver.com)



- Ultra Wide SCSI
- Ultra2/LVD
- 10/100 Ethernet
- Compact PCI
- Multi-Function Adapters

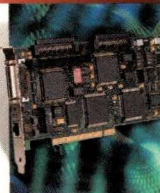

© 1999 IntraServer Technology, Inc. All other trademarks are the property of their respective owners.



# largest Sun<sup>®</sup> **COMPATIBLE**

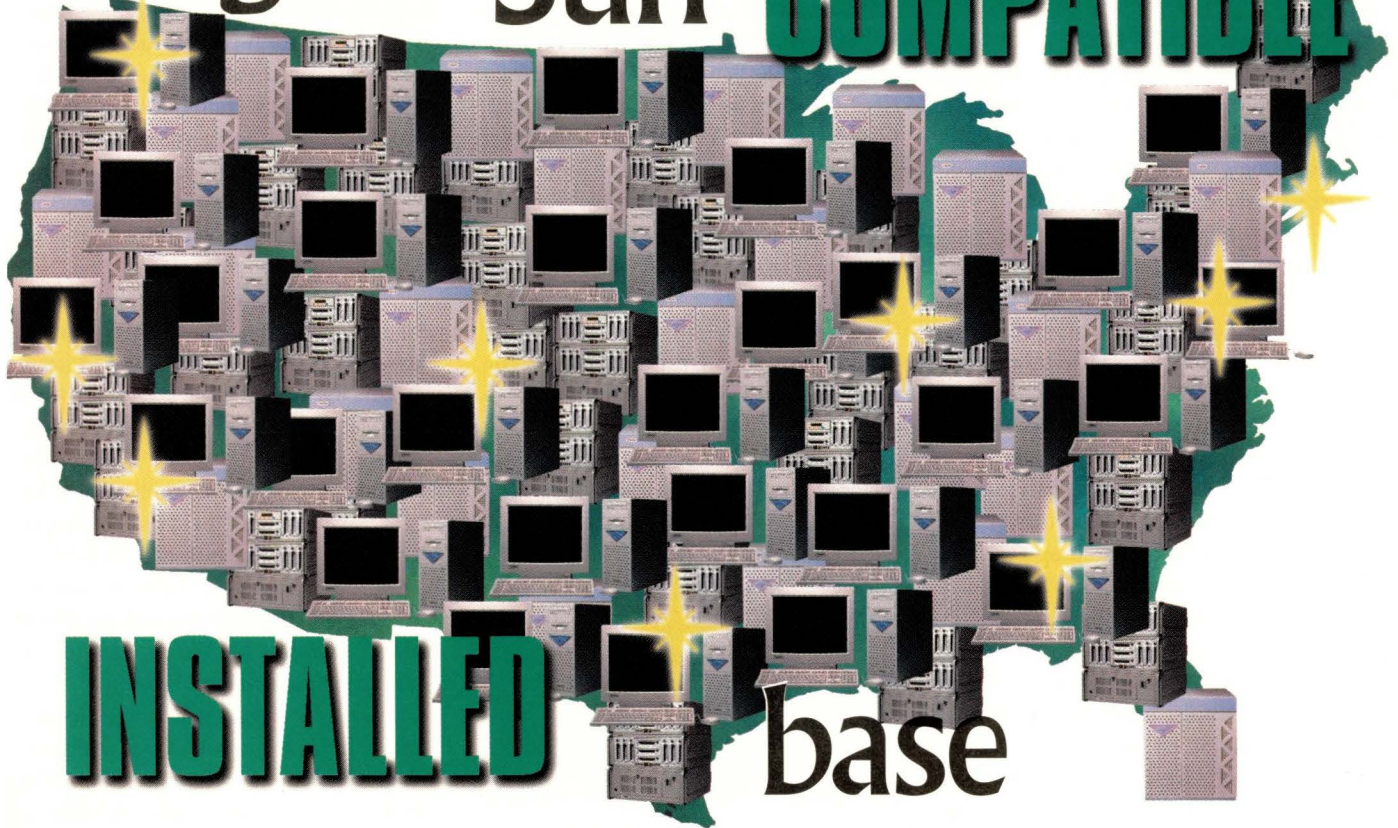

# INSTALLED base

Single, Dual or Quad Processors

## **SERVERS**

And the numbers just keep on growing. Tatung has 10's of thousands

of high quality workstations, servers and storage systems installed across North America and is second only to SUN in SPARC-based computing.

Rely on Tatung for a broad line of powerful workstations and servers that use the latest in 100% Sun UltraSPARC microprocessors and are priced less than comparable Sun systems.



All Tatung systems are manufactured in the U.S. and are available across the country from our regional sales offices.

Visit our web site [www.tsti.com](http://www.tsti.com) or call 1-800 659-5902 today for the nearest office and we will power up a system for you.

## **WORK STATIONS**

### Desktop and Rackmount Solutions for Commercial and Industrial Applications



*The Intelligent Choice in SPARC Computing Solutions*

Phone 1-800-659-5902 or (408) 383-0988

email — [mkt@tsti.com](mailto:mkt@tsti.com)

website — [www.tsti.com](http://www.tsti.com)

Tatung's full line of UltraSPARC workstations, servers and storage.

©1999 Tatung Science and Technology, Inc.

All trademarks are property of their respective owners.

18GDA

Circle No. 10



## i-Planet: A World Wide Desktop

Mobile workers may soon have an easier time accessing internal corporate files and applications thanks to Sun Microsystems Inc.'s April announcement of its i-Planet Web portal software.

i-Planet reportedly enables users to access server-based applications running on Windows NT, UNIX (including Solaris) and mainframe hosts using a standard Web browser. That means, for example, a traveling employee could use a hotel business center PC to access an application residing on the corporate mainframe, or a sales representative could run a presentation off a customer's workstation. As long as the desktop client is equipped with a Web browser and a TN3270 client (for mainframe access), it can use i-Planet.

"Any organization can take a UNIX X Window application, a mainframe 3270 application or an NT application and, through the i-Planet software, deploy it without making one change [to the application]," says Kevin Kalajan, senior engineer for Solaris software at Sun and former chief technology officer of i-Planet Inc., which Sun purchased last year.

However, IT managers shouldn't count on i-Planet being a simple plug-and-play solution, says Dave Kelly, vice president of Hurwitz Group Inc., an analyst firm based in Framingham, MA. Network administrators should plan on having to devote some time to configuring and integrating the product with their back-end resources, something that may slow the rate of adoption of i-Planet initially, he says. "i-Planet will take some market education. Sun will have to show people how to utilize the technology," says Kelly. "But the market [for i-Planet] is a large one because just about everybody has these problems with remote access and secured access."

Companies may also need to purchase software above and beyond the \$10,000 starting price for i-Planet. While i-Planet needs only a browser on the desktop, it does require additional, remote access software installed on the server. For access to Windows NT applications, for example, users will need to

purchase Citrix Systems Inc. WinFrame software or Microsoft Corp. Windows NT 4.0 Terminal Server Edition (TSE). For UNIX X Window System applications, i-Planet supports GraphOn Corp. Go-Joe software (a five-user license for Go-Joe is included free with i-Planet).

Companies can avoid the need for remote access software if they have an existing Web-enabled application that can be accessed via pure HTML, or if they require only email or file transfer capabilities. For simple email or file access, i-Planet comes with two Java applets—Netmail and Netfile—which can be downloaded to the browser without the need for additional server software.



The product, which has been beta-tested internally by Sun employees in the form of the Sun.Net corporate portal, is targeted not only at enterprise customers but also application service providers (ASPs), which provide hosted applications.

i-Planet should find a receptive market in application hosting, says Ted Schadler, analyst with Forrester Research Inc., Cambridge, MA. "The primary issue [for Sun] is whether there is an attractive market for applications that somebody else owns. And the answer is absolutely yes," says Schadler. In fact, Forrester is predicting a boom in the application hosting market over the next few years, reaching \$15 billion in revenue by 2003, up from \$2 billion in 1999.

One ASP already interested in i-Planet is Digex Inc., Beltsville, MD. Digex, which manages dedicated Internet servers for corporations, got into the hosting business earlier this year when it began offering hosted electronic commerce applications from Pandesic LLC, Sunnyvale, CA. Now, Digex plans to offer i-Planet as well.

"Many of our users are having a hard time with [access to] their legacy sys-

tems," explains Charles Boyle, director of research and development at Digex. "This gives them the same access as they'd get from the office, no matter where they are—in a hotel, using a [public Internet] kiosk—it looks the same." Boyle says i-Planet is ideally suited for companies that have either a distributed or traveling workforce, or those trying to consolidate IT resources.

Lawson Software, Minneapolis, MN, also sees plenty of potential in i-Planet. Lawson is planning to integrate i-Planet with its Lawson Insight II enterprise resource planning (ERP) application. "What i-Planet does is give a single point of authentication for all applications. So our customers will be able to access everything over the Internet, instead of having to install RAS [remote access software] on their laptops and do direct dial-in," says Jim McAllister, director of advanced technologies at Lawson.

Security is supplied through Secure Sockets Layer (SSL) and URL redirects. When i-Planet detects a request from the client, it encrypts the traffic and directs it to the i-Planet server before routing it to an internal mail or application server. This provides the same level of security as having a virtual private network (VPN), says Evan Miller, Internet email services manager for Texas Instruments Inc., Dallas, TX, which just completed an i-Planet pilot to provide email access to its employees.

"You can put i-Planet on the firewall, and then someone from an airport kiosk could log on, authenticate themselves, establish a secure connection via SSL and then have a reverse proxy that forwards the IMAP connection to the Internet mail server," Evans says. i-Planet is also useful for providing internal email access to employees who don't have their own PCs. "In our factories, no one has their own desktop. This gives us a shared-PC solution," Evans says.

Currently, i-Planet runs only on Solaris servers. However, future releases will support Windows NT and will add load balancing and improved scalability, according to Sun's Kalajan. "Today, with one of the larger Sun machines, you might get on the order of 10,000 simultaneous users. We want to get that up to 100,000 or 1 million."—*sjh*



# When it absolutely positively has to stay up all the time.

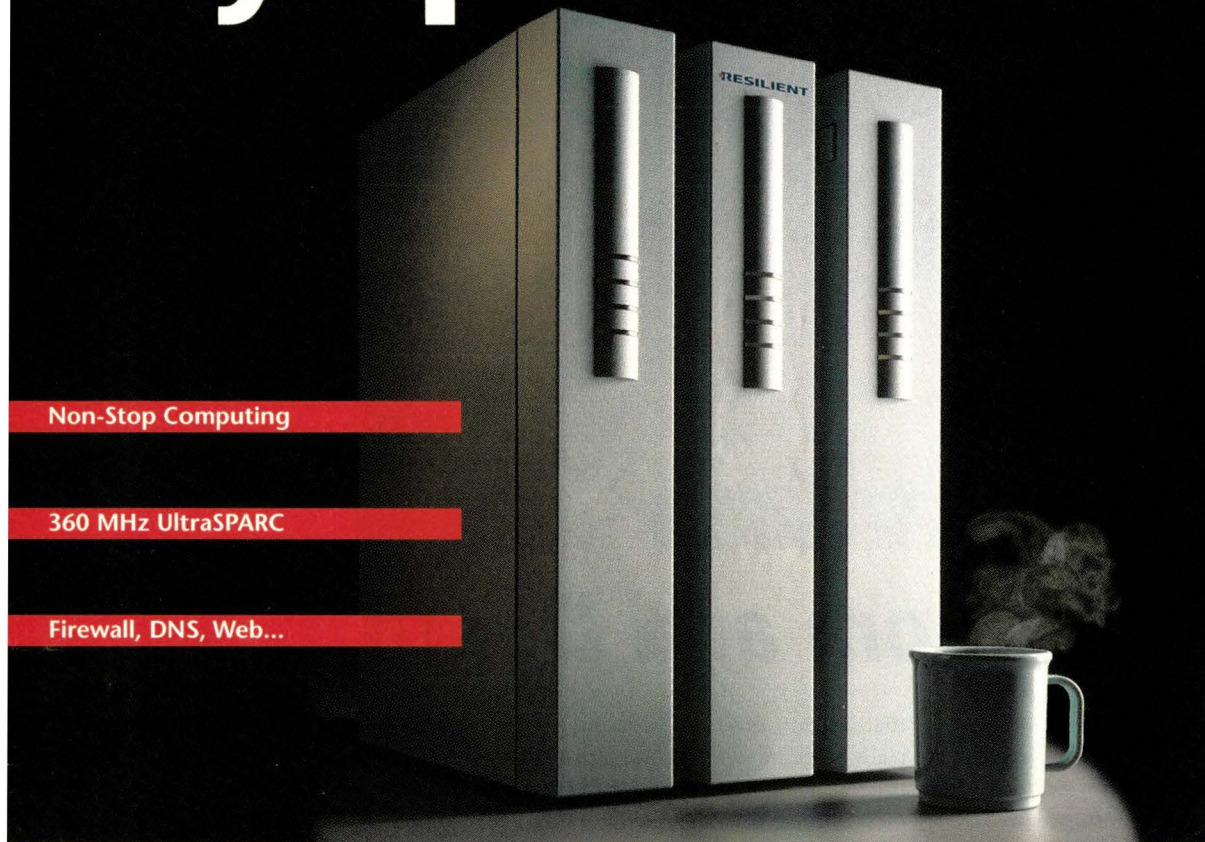

Available in Rack Mount

**Introducing the Resilient® Ultra fault tolerant server. It delivers when any downtime or data loss is too much.**

**W**e created the Resilient® Ultra fault tolerant server specifically for your mission critical network computing applications: firewalls, web, DNS, NIS+, license server, telecom, databases — any job where even a little downtime is too much.

Unlike software-based “high availability” schemes, our triple redundant architecture keeps applications running non-stop even if a logic board fails. Which means you won’t experience unrecoverable data loss, service interruptions, high administration costs, reconfiguration delays — or constant worrying about your critical applications.

Resilience fault tolerant servers are based on industry-standard Sun UltraSPARC technology and the Solaris OS, so they integrate seamlessly with your existing network and applications. Their hot-pluggable modular construction offers exceptional ease of maintenance — you can even replace any failed component in under 60 seconds.

So now you can enjoy non-stop availability and the performance of an UltraSPARC server — at a surprisingly low cost. For an informative white paper with more information about the new Resilient Ultra, simply call us at (800) 977-9008 or visit [www.resilience.com](http://www.resilience.com).

**RESILIENCE**  
Fault-Tolerant Network Computing™

1755 Embarcadero Rd., Suite 120 · Palo Alto, CA 94303 · (800) 977-9008 · (650) 843-3600 VOICE · (650) 843-3609 FAX · email: [sales@resilience.com](mailto:sales@resilience.com)

©1998 Resilience Corporation. Resilience, Resilient are registered trademarks of Resilience Corporation. UltraSPARC® is a registered trademark of SPARC International, Inc. Products bearing SPARC trademarks are based on an architecture developed by Sun Microsystems, Inc. All other trademarks are property of their respective holders.

Circle No. 11



# Ask Mr. Protocol

by Michael O'Brien

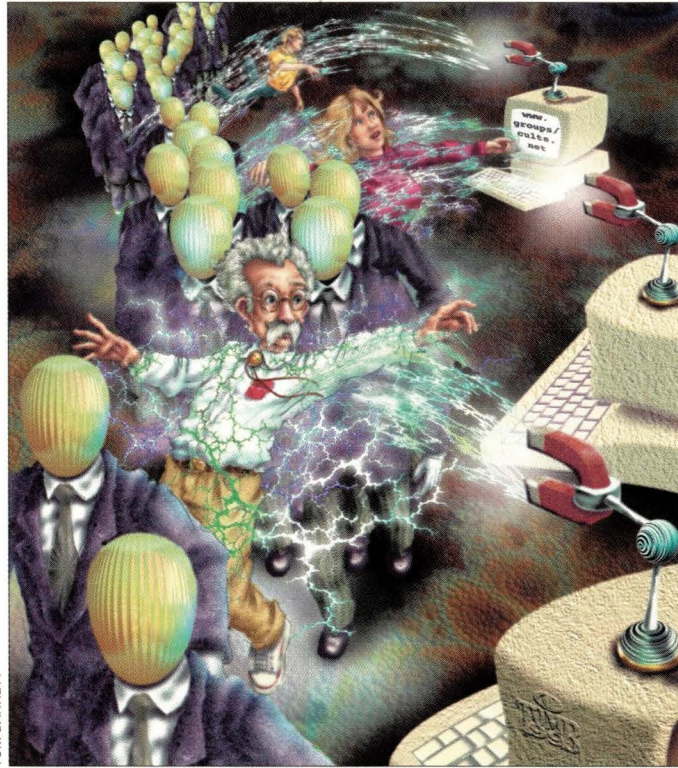

TOM BARRETT

*"I like you. Go home."*

## Doom and Death

**Q:** *You keep telling us that Mr. P. has a little problem with reality. Like, he has very little reality, and that makes him the way he is. How do you take that? Isn't it alienating, being cooped up here with him?*

**A:** Well, it does pay the bills. And it's not so bad, really. His entertainment value is high. I never do know how he's going to take new things that come along. For example, his notion of what's important in the world is measured solely by how much Internet traffic is devoted to it, which makes it rather amusing to watch him trying to make sense of the online versions of various newspapers. Newspapers themselves, of course, are useful only as bird-cage liners, and because his bird is virtual, along with its cage, watching him change the liners is rather unsettling, as I've mentioned before.

Occasionally, though, something comes along that generates big Internet traffic and big real-world traffic, and

that's when conversing with him gets really interesting. Of course, most of the time his main reaction is one of complete outrage when he discovers that some high-flying site has decided to bounce any browser other than Internet Explorer or Netscape. It's the only case where I've ever seen him advocate an outright lie. He believes browsers should be able to tell complete confabulations to sites with attitudes like that. HTML is served up for browsers to make what they can of it, and bouncing a browser because it lacks credentials is itself an act that lacks class. Completely. Mr. P. fully supports, for example, Steve Weyer's brilliant little browser for the Apple Newton, Newt's Cape (<http://members.bellatlantic.net/~sweyer/newton>), which can easily be configured to lie through its tiny little teeth about its identity to overcome just such nonsense. He figures that Opera, Lynx and other second-tier browsers should be equally empowered. A man's browser is his own business.

And on the subject of "mind your own business," we have a topic that is bound to stir up a few people. Mr. Protocol, to my complete surprise, has actually taken notice of the tragedy at Columbine High in Littleton, CO. Thanks to the delays in paper publications that would so infuriate Mr. Protocol if only he paid any attention to paper publications, it will be old news by the time you read this; but if the past performance of the press is any indication, this particular cud will still be being chewed when this hits print, if only due to the chronic indigestion the subject seems to cause.

Let us begin by peeling off a few layers. First, the national media. Edward R. Murrow has been dead for years, and this fact has not been lost on the companies that have been buying up media outlets. They play to the bread-and-circuses crowd. "Our Children: Threat or Menace?" is about as useful as they've been. The number of children who have shot up their schools has climbed from





**ANCIENT DILEMMA**

**THE ENTERPRISE IS DEMANDING  
MORE FROM YOUR NETWORK.  
TOO BAD YOUR PERIPHERALS  
CAN'T KEEP UP.**

**XEROX SOLUTION**

**CONNECT A XEROX DOCUMENT  
CENTRE TO YOUR NETWORK. PRINT  
FROM ANY PC OR MAINFRAME.  
SCAN TO E-MAIL OR ANY WEBSITE.  
HOLD ON, PRODUCTIVITY IS ABOUT  
TO TAKE OFF.**



**DIGITAL**  
THE DOCUMENT COMPANY™

**XEROX**

XEROX, The Document Company, the digital X, Keep the Conversation Going, Share the Knowledge, and Document Centre are trademarks of XEROX CORPORATION. 36 USC 380. This model may contain some recycled components that are reconditioned.



[www.xerox.com](http://www.xerox.com)

**1-800-ASK-XEROX ext. 388**

You don't want anything to slow down your network. The Xerox Document Centre family delivers on the promise that a digital system can boost productivity and enhance the value of your network. Best of all, it allows work-

groups to go from paper to digital and back again. It's also easy to install and maintain. And as an investment it provides reliability and flexibility. It's not a peripheral, it's the platform that will keep your business on track.

**KEEP THE  
CONVERSATION  
GOING.  
SHARE THE  
KNOWLEDGE.**



zero to about five in the last couple of years, and fearless, eagle-eyed reporters have spotted a trend. Now, regardless of the fact that the only trends broadcast reporters are able to spot these days are trends in the ratings, we should note that actually, crime among schoolchildren is at its lowest level in 15 or 20 years. What's way up is the rate at which sober, middle-aged men are stepping off the curb in record numbers, and taking others with them; cf the gentleman in Santa Ana, CA, who recently ran his car into a schoolyard because his girlfriend had given him the pitch. He wasn't in a fashionable age group, so while he got plenty of local coverage, no one is pointing to him as part of any national trend. Not even though adults have been killing children all along, and now seem to be doing so at record rates.

By far the most provocative reportage, and some of the most responsible, has been coming from sites on the Internet, and especially from the rather unlikely site mounted by Slashdot (<http://www.slashdot.org>), whose motto is "News for Geeks. Stuff That Matters." Geeks, indeed. Slashdot columnist, Jon Katz, has mounted a couple of columns entitled "Voices from the Hellmouth," consisting mainly of excerpted and anonymized email from students who vividly portray exactly why events at Columbine came off as they did.

## The Good Old Days?

Let's go back oh, say 40 years, and look at the experience of the baby boomer generation. Eisenhower was in office, we were locked in the Cold War, everyone was looking to the House Un-American Activities Committee (HUAC) to save us from the godless Communists, and HUAC was looking to save us from communist Hollywood. Hollywood took notice, and film noir was replaced by "Singin' in the Rain." In the aftermath of World War II, there was a chicken in every pot, the Depression was a fading memory, everyone had 2.3 children and schools were quiet places, just like in the *Dick and Jane* readers.

It's funny how that image persists to this day. Actually, this was the decade that made "juvenile delinquency" such a common subject that the words started to sound funny. Kids don't grow up quietly. Ever. And especially not if they're forced together in groups.

The reality is schoolchildren in the 1950s were every bit as savage as William Golding portrayed them in *Lord of the Flies*. The only error he made was that he assumed it was necessary to isolate the children from adult contact in order for these tendencies to be made manifest. With the horror of Nazi Germany behind us, and the horror of nuclear war ahead, society became rigidly conformist, and the greatest rigidity was imposed on schoolchildren who had no say in the matter. The culture was utterly unable to accept plurality, and those who did not fit the mold were persecuted mercilessly by their peers, by their teachers, by their school administrators and often by their parents. Having no other outlets, the misfit children suffered in silence, or rebelled and were termed "juvenile delinquents."

The 1960s cracked this mold. Society in general, and parents in particular, have by and large become more accepting of

differing modes of behavior, particularly as the rebel children of the 1960s have had the tables turned on them by their own children. They may not approve, but they can identify.

Schools, however, despite curricular reforms, have by and large avoided any cultural reforms. They march to the same beat they stepped to during the Eisenhower administration. Individual teachers may nourish individuality; the system as a whole does not. Schools are invidious, insidious, dangerous and subversive, because while their fundamental mission is to teach our society's democratic ideals along with a large, fixed load of subject matter, they cannot be run democratically. Schools are, and must be, fascist enterprises. The most successful schools are those which engage the students sufficiently to make them understand why this fascism is necessary, and why it's a very good idea to leave it behind as soon as practicable.

To expect an ongoing institution to continually preach its own dangers is foolish. Schools are massively conservative institutions by nature. Our society, forced into accepting pluralism, has reached a stage where some are tired of it all and yearn to hear a single voice, as Germany did after World War I. The schools stand ready and willing to step up to the bar.

The degree of conformity demanded by most schools today is frightening. One example, among many, is the idiocy engendered by "zero-tolerance" laws, which see children expelled for bringing water pistols or Tylenol to school. One rule fits all. One behind-the-scenes argument that is often made in such cases is that enforcement must be arbitrarily absolute in order to survive a court challenge. Most people would say that choosing between expelling a kid for possessing a water pistol and risking a court challenge, is a no-brainer.

In the wake of the Columbine tragedy, one report centered on a middle school that required all of its students to wear blue and white "in solidarity" with the students of Columbine. The only problem was none of the children had blue clothing; blue, in that neighborhood, was a gang color and, hence, forbidden. One girl had been suspended the previous quarter for wearing a blue sweatshirt.

Conformity. No pressure to conform in a school is as powerful as peer pressure. Children are by nature violently conservative. Literally violent. They do not, in general, tolerate differences of opinion, taste, clothing or culture. Combined with an administrative culture that believes the ostracism of outcasts is all a part of "socialization," the wonder is that schools did not start turning into smoking craters a couple of decades ago. The one thing this proves is that children are adaptable. Any adult subjected to the uniform denigration, degradation and abuse that a school misfit enjoys would crack and go postal in a matter of months. In fact, they do. That's why there are more of them. That's where the term "go postal" came from, remember? The quiet guy with a temper.

What is more disturbing is that the pressure for conformity is being replaced by a witch hunt.

Students across the country are being suspended and expelled for the content of their Web sites set up on hosts which have nothing to do with the school. The American Civil Liberties Union (ACLU), according to *USA Today*, is





Mission Critical LDAP

providing real performance

for Driving corporate solutions

from the engineers who wrote the standards



**Innosoft Directory Services** pull together

- our high performance LDAPv3 server
- our unique suite of security and integration tools
- unsurpassed expertise and experience
- 24x7 technical support

Corner-stones for building a complete enterprise directory solution.

Test drive Innosoft's Directory Services today by calling **1-800-552-5444** for a no cost 30 day evaluation.

**IDS** Innosoft Directory Services

- LDAPv3 distributed directory servers
- LDAP Proxy firewall
- LDAP/X.500 directory integration
- Java and C client SDK
- LDAP-enabled scriptable administrative tool kit
- SSL/TLS transport layer security
- Directory synchronization

**Platforms**

- Sun Solaris
- Windows NT
- Red Hat Linux
- IBM AIX
- Digital UNIX
- OpenVMS
- HP-UX



fielding hundreds of telephone calls per day from students and their families looking for help in protecting their First Amendment rights. In one school, a student who had been suspended for the content of his private Web site avoided expulsion by the intervention of the ACLU. In another case, a student in a similar situation chose to delete the offending site and apologize so that he could graduate with his class and go on to college.

Let's see what church leaders have to say about this situation. From the Westboro Baptist Church in Topeka, KS:

"Two filthy fags slaughtered 13 people at Columbine High, and the sodomite-controlled media and the Littleton, Colorado community are engaged in a massive conspiracy to cover up the fag component of the bloody crimes."

If you're startled to see text like that in a computer magazine, let alone issued by a church, be it noted that this is an example of the leveling influence of the Internet...and it is a key to what is really going on at Columbine and elsewhere.

The text is taken from the Web site of the Westboro Baptist Church, whose URL is <http://www.godhatesfags.com>. Now, it's an indication of Mr. Protocol's odd priorities that the biggest question he has about this URL is, "What's a church doing in the .com domain?" Good question. Makes you wonder what it's really out for.

Perhaps more interesting is the structure of the site. It has a few pages of text, all in pretty much this tone, put in as regular HTML hypertext. Most of the content, however, is contained behind an index page of bulletins and messages issued by the church. Each link leads to a large image, which is a scanned image of a broadsheet published by the church, using a printing press inherited from Ben Franklin, judging by the print quality.

And this is the key: Just about anyone reading this page could, if they wanted to, go to that Web site and read every single one of these broadsheets. Doubtless some will, and will feel refreshed at finally finding someone of a clerical persuasion who shares their views. Others will not.

But, please be it noted that almost no one reading this would have any reasonable opportunity to see these broadsheets on paper, as printed by the church. Paper must be bought, printed and distributed, and only a small percentage of Americans, whatever their beliefs, can receive these, owing simply to reasons of cost.

Because the site consists of scanned broadsheets, it is obvious most of the creative energy of this church is channeled into traditional outlets, with the Web page being an afterthought. For this, most of us should be thankful. The only "message" most of us have foisted off on us from this church is whatever we gather on the nightly news, when its members picket something like Matthew Shepard's funeral. Their output of broadsheets, pitifully small compared to what they could do with a really aggressive Internet campaign, passes us by, unnoticed.

But the Internet is there, and it is a great leveler. The people who are using it, by the hundreds and thousands, are those who are most at risk in this campaign of oppression: the nerds, misfits, goths and outcasts who are suddenly, each and every

one, being treated like bombs to be defused rather than as human beings.

One good reason why overall juvenile crime is down over the past couple of decades, despite any meaningful reform in schools, may well be that students generally have more outlets available to them. The Internet is far from the only one—a look at goth club culture will show that—but it is an important one. Those who play Doom and Quake are engaging in what Aristotle called *katharis*: the generation of real emotions in response to a fictitious environment, which allows those emotions to be expressed and acted on harmlessly. The gunmen of Columbine weren't driven to their deeds by these games. The truth is they were so wracked by hate that these games were unable to sublimate their drives. Such people, of any age, are thankfully rare.

Mr. Protocol has pointed out in the past that the Internet allows people with the rarest of interests to find one another, and (in the case of legal interests, at least) publicize themselves. As this is being written, we are fighting a war in Yugoslavia where all factions (and there are a lot more than two) have posted Web pages touting their cause.

The backlash of the Columbine massacre is generating a similar outpouring onto the Internet of those who find themselves making the rocky transition from ignored outcast to persecuted minority. So large is the flood that mainstream media are beginning to take notice. Here and there, particularly in the print media, one finds a story or two about the effect of all of this soul-searching-turned-scapegoat-finding.

There are those out there who are saying outright, and with a straight face, "School safety is more important than individual rights."

It's an appealing position, and Columbine makes it look like a necessity. That doesn't make it right, any more than World War II made Manzanar right. If we're lucky, the courts will not take 40 years to say so.

Setting aside for a moment the elusive Mr. Protocol: I helped to build this Internet. Though I was not a chief designer, I have been on the front lines the whole way. I, and others like me, always intended it to be what Ursula LeGuin calls an *Oikumene*: a common meeting ground for all. *S/W Expert* is a technical magazine, so there's a good chance some of its readers may be members of the "trench-coat crowd." If so, and if what I've said seems right (or wrong!), let me know. You will be heard. My address is below. ➡

---

*Mike O'Brien has been noodling around the UNIX world for far too long a time. He knows he started out with UNIX Research Version 5 (not System V, he hastens to point out), but forgets the year. He thinks it was around 1975 or so.*

*He founded and ran the first nationwide UNIX Users Group Software Distribution Center. He worked at Rand during the glory days of the Rand editor and the MH mail system, helped build CSNET (first at Rand and later at BBN Labs Inc.) and is now working at an aerospace research corporation.*

*Mr. Protocol refuses to divulge his qualifications and may, in fact, have none whatsoever. His email address is [amp@cpg.com](mailto:amp@cpg.com).*



# UNIX Basics

by Peter Collinson, Hillside Systems

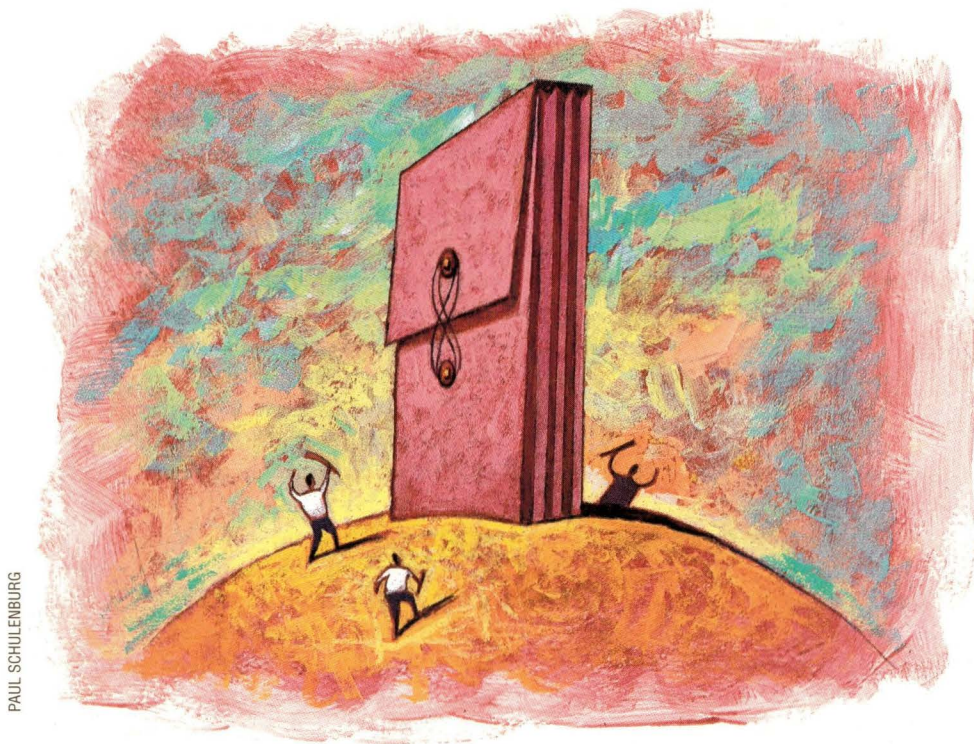

PAUL SCHULENBURG

## Just what is that File?

Whenever I get a new computer system, I spend some time poking around the file system to see what is there. Of course, one of life's universal rules applies: looking is generally fine, touching needs to be discouraged. A long time ago, I learned that running commands you just happen to find lying around can cause huge amounts of grief. It's considerably more dangerous to run an unknown command as superuser, so don't ever do that. "Danger, Will Robinson!"

Incidentally, if you are a new user of a free UNIX system of whatever flavor, be sure to set up a user account for yourself that doesn't have superuser privilege. You should only log on as `root` in extremis; it's better to get into the habit of logging on as a normal user and using the `su` command to obtain unprotected privilege only when needed.

That being said, it seems to me there are an increasing number of commands and files on UNIX systems that are unexplained and mysterious. You'll find

them scattered around the system and, occasionally, by looking at output from the `ps` command. It used to be that all (maybe only nearly all) commands had associated manual pages, so if you found a command called `doit`, there was a good chance that `man doit` would tell you what the command was. If the `man` command failed, the command was perhaps lurking quietly on an associated manual page and it was possible to use `grep` to search through the manual page sources with the hope of finding something sensible. Well, my Solaris system certainly seems to possess some "secret" commands, whose purposes are barely discernible. Just what does `/sbin/bpgetfile` do? I think the lack of documentation is a retrograde step.

On Linux, you are presented with at least three sources of basic information: manual pages, the GNU info system and the Linux HOWTO documentation. Having to look in three places is not helpful. Attempts are being made to create one single coherent set of docu-

mentation, or at least have a unified interface to the disparate document sources. The newly announced GNOME desktop has one GUI that accesses the various information sources. It's still not possible to search for some random text, and I find this annoying. The ability to `grep` through manual pages is a great boon and can save a great deal of time.

### Looking at the File

OK, so you've found a mysterious file and want to know something about it. What do you do? Well, you may be able to deduce something about its contents from its file name. This is not guaranteed because UNIX itself cannot enforce any rules on how a file is named. Nevertheless, files are often named using standard suffixes. For example, source code for the C language will be found in a file that ends in `.c`. We are all kept in line following this convention because the C compilation command `cc` (or `gcc`) recognizes the standard suffixes and



processes files differently based on their suffix. However, there's nothing to stop me from placing a shell script into a file called `script.c` and happily executing the script. So, the file name may not really tell you much about the file on a UNIX system.

We really need to look at the contents of our mysterious file to be sure what it contains. UNIX supplies the `file` command, which opens files and tries to tell us what they contain. Of course, you need to have appropriate permissions to read the mysterious file and, actually, most UNIX files have their permissions set to allow reading by all. In the example below, I ran the `file` command on my Solaris system in a directory where I have collected various files for demonstration purposes:

```
$ file *
core: ELF 32-bit MSB core file SPARC
      Version 1, from 'cat'
dir:  directory
ix:   English text
ls:   ELF 32-bit MSB executable SPARC
      Version 1, dynamically linked, stripped
pdficon.gif:  GIF file, v87
typescript:  ascii text
```

I've folded some of the lines for printing purposes. The `file` command examines each of the files you give it on the command line. Each file is subjected to a sequence of tests and a message is printed guessing the contents of the file.

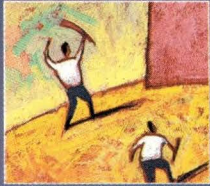

**If the `file` program cannot locate a magic number it knows, then it uses a set of heuristic tests to check on the file.**

The first set of tests uses standard UNIX system calls to see what can be determined about the file. UNIX provides the `stat` system call that returns a file's *metadata*, the information the system holds about each file. The metadata contains the file's owner, its access permissions, modification time information and size. The file type is stored as part of the file permissions. UNIX doesn't have many different file types; the types stored are only those that are used internally by the kernel to distinguish a plain file from a directory, or a symbolic link from a file that's used to access a peripheral and so on. In the above example, `file` tells us that `dir` is a directory by looking at the file's metadata.

The second set of tests in the `file` command looks for magic numbers in the file. Many file formats, both text and binary, contain a magic value at their start that is used in the normal course of processing to check that it does contain correct information. For example, a file holding a document in Adobe Systems Inc.'s Portable Document Format (PDF) starts with the string `%PDF`, which allows the Acrobat reader to refuse to play when supplied with any other file format. Actually, `%PDF` is followed by a hyphen and a PDF version number,

which enables Adobe to alter the way the PDF protocol works as time progresses. The Acrobat program can look at the version number and say: "OK, this version did *this* in such and such a way." The Acrobat reader is also able to announce its own demise: "Sorry, the file contains a format I don't understand, please get a new version of Acrobat."

Anyway, there are a great number of these telltale magic numbers used by the `file` program to deduce the basic contents of the file. In the original versions of `file`, the magic values were compiled into the binary and could not be altered. These days, you'll find them in a text file called `/etc/magic` (the actual position of the file may vary from system to system; it's in `/etc` on Solaris). Solaris has a manual page that describes the format of the file, so you can add in the knowledge of your local files should you wish to.

If a magic value is found in the target file, then the `file` program may continue to obtain information about the file using some code that knows about specific file contents. For example, most versions of `file` will tell you the name of the command that dumped core and created a `core` file. Incidentally, I induced the `cat` command to generate the `core` file in the example above. The `cat` program didn't crash and burn.

Executable programs use several magic numbers to indicate their type, which are understood by the kernel when the program is launched. The `file` program will decode the binary header and tell you not just the type of program, but will supply other information as well. Perhaps the program is "dynamically" linked, meaning it pulls some portions of its code from a shared library at the start of its run. The `file` command will tell you whether the file containing a program has been "stripped," which means its symbol table has been removed, making the file considerably smaller. The symbol table is useful when debugging the program, it allows debuggers to find the value of named variables in the program. The information is not really relevant when the command is "in production use."

If the `file` program cannot locate a magic number it knows, then it uses a set of heuristic tests to check on the file. These tests are used to tell us that the `ix` file in my example is "English text" and the `typescript` file is "ASCII text." Actually, the `ix` file contains HTML in English, and the `typescript` file is the output from the `script` program, logging a terminal session. It contains several nonprinting characters, like the backspaces that I typed when I deleted some text on the input line.

The `file` program does a fairly good job. At least, it can stop you loading binary rubbish down to the screen. Random binary data that is sent to a screen can have bad effects because the data can contain sequences the terminal (or terminal emulator) interprets as programming information. I find my `xterm` windows hang occasionally because I've managed to `cat` a binary file at the screen.

## The strings Command

Well, we've looked at our mysterious file and discovered it's a program or a text file that contains what looks like configuration data. What next? Well, something must be using the file, and that something could be a compiled program. On



# Control your Sun servers — from anywhere

Aurora ControlTower console management system takes you beyond the limitations of hardware switches and network-based tools. One SPARC Solaris server functions as a common monitor and keyboard for up to 128 UNIX systems. But that's only the beginning. ControlTower software utilizes a serial console connection so you can access managed systems, perform diagnostics, and reboot a system even when the network is down. Remote access capabilities let you respond to a system emergency anywhere in the world, from office or home.

- Monitor and control one or more data centers from a central or remote location
- Same functionality as a keyboard attached directly to a system
- Access real-time data and a time-stamped log of system messages
- User-definable parameters for all or any managed system
- Security features control access to console manager servers and/or managed systems

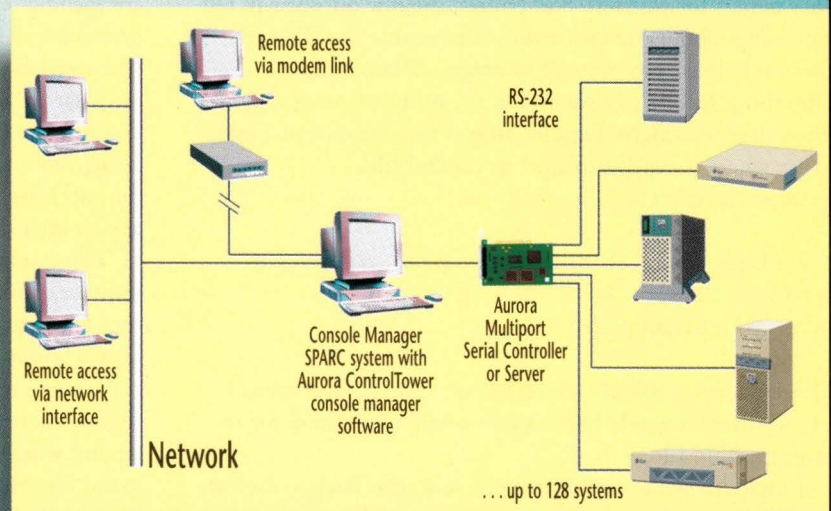
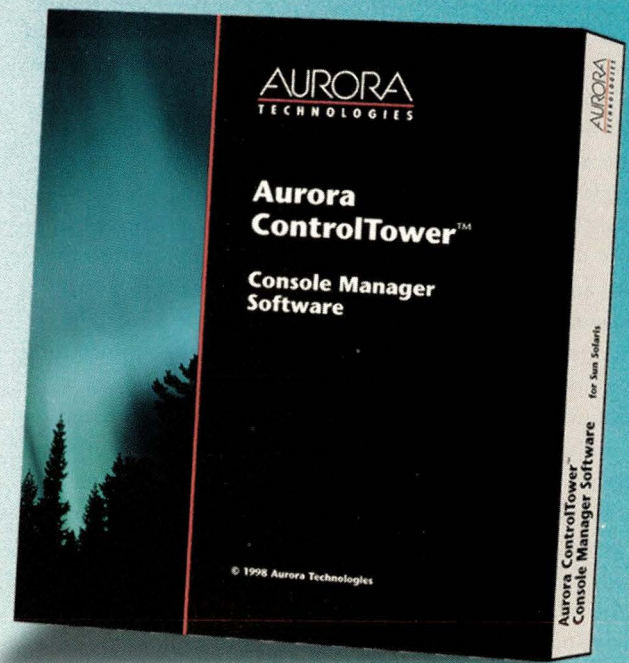

For information on how to obtain a free evaluation copy of ControlTower console manager software, go to <http://www.auroratech.com>.

## Aurora ControlTower™ CONSOLE MANAGEMENT SYSTEM

**AURORA**  
TECHNOLOGIES  
A Carlo Gavazzi Group Company

Phone: 781.290.4800 FAX: 781.290.4844  
E-mail: [info@auroratech.com](mailto:info@auroratech.com)  
<http://www.auroratech.com>



Linux, or other source-full systems, you can search the source with `grep` looking for the file name; assuming, of course, that the file name is significantly distinctive, allowing the string to stand out from any normal file contents.

However, on a binary-only system, like Solaris, things are a little more complicated, and we need to employ a different strategy. We can use the `strings` command to scan files looking for C-language text strings. When programming in C, any string (such as a file name) will be compiled into the binary and stored in contiguous bytes terminated by a byte containing a null character (a character of value zero). The `strings` command makes use of this knowledge by scanning any file that is supplied on its command line looking for a minimum of four contiguous ASCII characters terminated by a null byte or a newline indicator. The four-byte minimum is imposed because sometimes machine code instructions can appear to be a legal string, and the printing of these sequences will get in the way of any real strings the program may contain. An option to the `strings` program allows you to control the number count.

Printing the output from a `strings` command for publication is likely to fill loads of column inches and tell you little. I suggest you run the command and see the full gory details for yourself. Sometimes, the raw output will tell you things about the mysterious file because the file will contain help strings or error messages. When looking for something specific, I usually run the output from `strings` through `grep`. Here, I am looking at the `sendmail` binary to see where it expects to find its control file, `sendmail.cf`:

```
$ strings /usr/lib/sendmail | grep sendmail.cf
sendmail.cf
/etc/mail/sendmail.cf
```

This `sendmail` binary contains `/etc/mail/sendmail.cf`, so there's a good chance that's where it will look for its configuration file.

I used the `strings` command a few years back to look at Year 2000 compliance on several machines. The standard C routine that translates time in seconds from January 1, 1970, into a structure that holds the day, month, year and time of day, delivers only the last two digits of the year. When UNIX was invented, many programmers printed the year from programs using a constant string in a print statement:

```
"19%d" or
"19%2d" or
"19%02d"
```

which made the printing code output "19" followed by the number of the year (`%d`), or the number of the year as two digits (`%2d`) or, more properly, the number of the year as two digits ensuring that any leading zero digit is printed as a zero and not a space (`%02d`). Well, as we approach 2000, we've hopefully learned to add "1900" to the year value to obtain the correct date, and the print statements have changed to

print the number as four digits:

```
"%d" or
"%4d"
```

Several years back, when I scanned binaries of a couple of systems looking for strings that contained 19%, I found only a couple of commands that contained old code. They are fixed now in recent releases, but it was illuminating to find how few commands did have this problem.

The scanning script for such an exercise is easy to construct. If we change into the `bin` directory, we can type

```
$ cd /usr/bin
$ ls | while read name
do
    echo $name
    strings $name | grep '19%'
done
```

Here, we use the `ls` command to generate a list of the file names and this is piped into a loop. Incidentally, you can't pipe program results into loops in `csh`, which is one very compelling reason to use a Bourne shell variant when programming. The loop reads the names one at a time into the name variable. For each name, we first `echo` it so that we can see what we are processing. We then run `strings` on the file and pass the output into `grep` looking for the appropriate string. We end up with a list of file names on the standard output. If we find anything in a file, the matched string will appear after the file name.

This is a quick hack, and is fine if there are only a small number of files being scanned. It's about the level of complexity where the code is easy to type into the shell and to get a result. Ideally, we'd like to have output only for the files that contain the string we are looking for. The script becomes slightly more complicated, and perhaps pushes the code to a point where you might think about putting it into a command file. Here's the more selective version:

```
$ cd /bin
$ ls | while read name
do
    $op = $(strings $name | grep '19%')
    if [ $op != "" ]
    then
        echo "$name"
        echo "$op"
    fi
done
```

The inner loop runs the `strings ... grep` command sequence as before, but captures any output into a shell variable using the POSIX `$ (...)` syntax that replaced the previous (unnestable) backquote mechanism. We now test whether we've found anything by looking at the result and only proceeding further if the result is non-null. I've quoted



# Running Into Potholes...



## On Your Road to NT and UNIX Connectivity?

Running into trouble trying to integrate your UNIX and Windows NT network? TotalNET Advanced Server (TAS) software will smooth the rough road ahead.

**TAS enables UNIX computers to become NT file, print and application servers.** Setting up and using TAS is quick and easy, thanks to intuitive, browser-based installation and graphical configuration wizards. No additional software is necessary on the NT workstation!

**NT File/Print/Application Services:** NT users access files and printers residing on UNIX servers using normal NT functions. TAS also enables NT users to access NT applications stored on a UNIX server.

**Common File System:** Data and applications are stored in a central TAS-based server where NT and UNIX users can easily access the same data.

**Transparent to the NT Desktop:** The TAS server is seen by NT users as a PC server, so users do not need to know UNIX to access resources on that server. No retraining is involved.

**Scalability:** TAS provides file/print/application services to thousands of NT and PC workstations.

Is your current solution steering you down the wrong road? Upgrade to TAS and save substantial time and money. Call today for details!



© 1998 Syntax, Inc. All Rights Reserved.  
All trademarks of companies whose products are referenced are hereby recognized.

# SYNTAX

2 5 3 8 3 8 2 6 2 6  
<http://www.syntax.com>

Circle No. 15



the arguments to the `echo` commands to preserve any newlines or spaces in the values.

We can extend this command sequence to search for all binary programs on a file system, by replacing the `ls` command in the scripts above with

```
find / -type f -exec file {} \; |
  grep ELF |
  awk -F: '{print $1}' |
  while read name
```

*The commands as above*

The `find` command is one of the delights of UNIX, and it is worth getting to grips with its somewhat arcane syntax. It scans a file system tree applying a set of tests to all the files it finds. In the above example, it says: start at the root of the file system (`/`) and look for all regular files (`-type f`). When one is found, the command between the `-exec` and the semicolon is run. The backslash immediately before the semicolon is used to tell the shell to pass the semicolon into the `find` command; otherwise, the shell would see it and think it was an end-of-statement separator. The curly braces in the argument to the `-exec` option are replaced by the name of the file. The effect is to run the `file` command on every regular file in the file system.

The output we obtain from the `find` command is the same as in my example at the beginning of the article. We now select only the executable files by using `grep` to choose the output lines that contain the word `ELF`. Having found the files we want, we need to reduce each output line so that it contains just the file name.

There are several different ways to reduce the line. I've chosen to use `awk` because the `file` command adds a colon after each file name and we can use this as a column-separator character. So, I tell `awk` to split its input into columns using the colon character (`-F:`). I know then that the first column will contain the file name I want. The rest of the `awk` command prints the first column `{print $1}`, and we now have a stream of file names that can be processed by the scanning code.

The scanning code I've outlined has many uses. I once used the technique to find the program that was writing a mysterious message to a log file. The message wasn't an obvious system error, and there was a good chance of finding the culprit and sorting out its problems by looking for the string in the binary.

## Follow-Up

I'd like to finish this month with some observations sent to me by several readers via email in reaction to my article entitled "Automation" (*S/W Expert*, April 1999, Page 26, <http://sw.expert.com/C2/SE.C2.APR.99.pdf>). One of the things I discussed in that article was the shell's `PATH` variable, and I showed you how you could create a series of directories to be searched when a command is typed into the shell. My correspondents complained that I had put the current working directory into the example path. I still do this, so I can create commands in the current

directory and execute them without having to explicitly say `$. /command`.

However, putting the current working directory in your search path can be dangerous in some environments, because it allows an unscrupulous person to place their own version of a common command in a directory and fool you into running it. A favorite student trick when I was running academic systems was to send mail saying, "Look at this neat command `fggxu` in my directory." You would use `cd` to move into the directory, type `fggxu` and get a "Command not found" message. You would then type `ls` without thinking, and find that the command was `fgxu`. It was probably neat, too. However, what you didn't spot was the private version of the `ls` command that was lurking in the directory and, of course, you'd run that command when you typed `ls`. The private `ls` was run as you, with your permissions at the time, and could do a variety of things ranging from funny to nasty.

The potential for running a fake or Trojan command is the reason why you may not want to place the current working directory into your `PATH` variable. Doing so adds a security hole to your environment, meaning that any standard command you are trying to run may not be the command you think it is.

One way to avoid the problem is to never allow the shell to execute a command from the current working directory by ensuring that your `PATH` variable doesn't contain it. Another way is to place the current working directory at the end of the chain of directories, so the common commands will be found and used before any fake ones.

Whether this is likely to happen to you is dependent on your environment. You need to take a view on this, as lawyers say. →

---

*Peter Collinson runs his own UNIX consultancy, dedicated to earning enough money to allow him to pursue his own interests: doing whatever, whenever, wherever... He writes, teaches, consults and programs using Solaris running on a SPARCstation 2. Email: [pc@cpq.com](mailto:pc@cpq.com).*

## Server/Workstation EXPERT

**NOW  
ONLINE!**

Search  
back issues of  
*Server/Workstation Expert Magazine*  
for key product reviews,  
crucial technical articles and  
unsurpassed columns.

<http://sw.expert.com>



# THE 8TH USENIX **Security** Symposium

August 23-26, 1999 • Washington D.C.

## Securing The Future — Today

Join computer security's insiders to examine the issues, tools, policies, threats and opportunities shaping tomorrow's system and network security landscape.



## The Next Generation of Security

Keynote by Taher Elgamal, President, Information Security Kroll-O'Gara

## Carefully Selected Technical Program

Over 20 refereed reports on the best new research in areas like:

Managing Access Control  
Intrusion Detection  
Creating Secure Environments for Software, and much more

Plus, invited talks by several of computer security's leading lights on topics including:

A Burglar Alarm Builder's Toolbox  
A New Framework for Electronic Commerce  
Public Key Infrastructure (PKI)  
U.S. Crypto Policy

## In-Depth Tutorials

Intrusion Detection and Network Forensics, Marcus J. Ranum  
Advanced Topics in Windows NT Security, Phil Cox  
An Introduction to Virtual Private Networks, Tina Bird  
How to Write Programs Securely, Matt Bishop  
What Hackers Know About You, Brad Johnson  
Cryptography From the Basics Through PKI, Daniel Geer & Avi Rubin

[www.usenix.org/events/sec99](http://www.usenix.org/events/sec99)

**USENIX**  
THE ADVANCED COMPUTING SYSTEMS ASSOCIATION

In Cooperation with the  
CERT Coordination Center



# NTegration

by Eileen Frisch



LYNNE CANNON

## More Useful Tools

In previous columns (see “Tools for Getting Things Done,” March 1999, Page 36, and “Useful Tools, Part 2,” April 1999, Page 35), we considered some of the tools Windows NT provides for performing important administrative tasks. This month, we’ll consider additional tools beyond what Microsoft Corp. provides, including both free software and commercial products.

These programs and utilities provide a wide range of functionality, ranging from system information and configuration aids to real-time system activity monitors and security-related commands. Unless otherwise stated, all of the tools are available at the Beverly Hills Software download site, <http://32bit.bhs.com> (usually in demo form for the commercial products). Note that we have had to shorten and reformat command output

in some of the examples that follow to save space, and we will be using three right brackets as our Windows NT command prompt.

### A Potpourri of Mostly Freeware

We begin with Service+ from Active+ Software (<http://www.activeplus.com>), which is intended as a replacement to the Services control panel applet.

When installed, it appears as an icon in the usual Windows NT Services window. It provides similar functionality to the normal applet with some enhancements, and it has the advantage that it can operate services running either on the local system or a remote host. The dialogs in Figure 1 illustrate this utility’s features.

The dialog box on the left shows the Service+ main window, which lists all

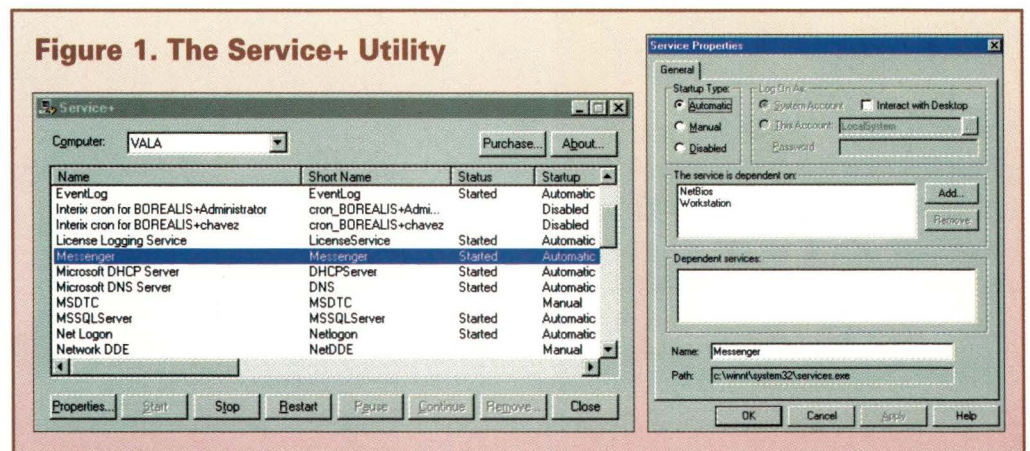





# The World's Premier Conference and Exhibition on Computer Graphics and Interactive Techniques

ENCOMPASSING:

3D modeling  
animation  
digital imaging  
dynamical systems  
gaming R&D  
haptic displays  
high-res technologies  
rendering  
simulation  
virtual reality  
visual effects  
visualization  
Web 3D

Images (left to right): InTouch © 1998, MIT Media Lab; Homage to Hilbert © 1998, Nelson Max, Lawrence Livermore National Laboratory; The Ceren Web Resource © 1998, University of Colorado at Denver; The Bush Soul © 1998, Rebecca Allen; Object-Oriented Displays © 1998, The University of Tokyo; The DNA Story © 1997, Andreas Koch, Digital Studio SA

+1.312.321.6830  
siggraph99@siggraph.org

Conference 8-13 August 1999  
Exhibition 10-12 August 1999

Los Angeles Convention Center  
Los Angeles, California USA

**SIGGRAPH**  
Los Angeles



Sponsored by ACM SIGGRAPH

[www.siggraph.org/s99/](http://www.siggraph.org/s99/)



of the services that are installed on the selected computer. The buttons at the bottom of the window allow you to start, stop, pause and resume the selected service. The Remove button enables you to delete a service (the `delssrv` command from the Windows NT Resource Kit can perform the same function). The Properties button brings up the dialog box shown on the right, allowing you to specify a start-up mode for the service, as well as the account that it will run as. In addition, this window displays the names of other services on which the current one depends, as well as subordinate services that depend on it. Finally, you can use the Name field at the bottom of the dialog box to rename the service. Pricing for Service+ starts at \$35 for a single computer system.

The `showme` utility (written by Don W. Alexander and distributed as freeware) is a useful tool for quickly determining disk space usage by subdirectory. As such, it provides similar functionality to the UNIX `du` command. Running `showme` displays the size of each subdirectory within the directory specified as the command's argument. For example, to display the sizes of the subdirectories under the usual Windows NT installation directory, use the following command:

```
showme c:\winnt\*.*
```

Note that the wildcards must be included. I find this command syntax hard to remember, so I have written a bat file called `du`, which adds the wildcards for me and precedes the command output with some header lines:

```
>>> type du.bat
echo off
cls
echo Subdirectory Bytes MB
echo -----
showme.exe %1%\*.*
echo -----

>>> du c:\winnt
Subdirectory Bytes MB
-----
Config 1614 0.00
Cursors 242572 0.24
Fonts 10509255 10.51
Help 4286241 4.29
...
system32 173287294 173.29
-----
```

As the output indicates, `showme` is not recursive and displays disk space usage only for first-level subdirectories under the starting directory (rather than descending to the bottom of the tree).

**Figure 2. The Samwise Utility**

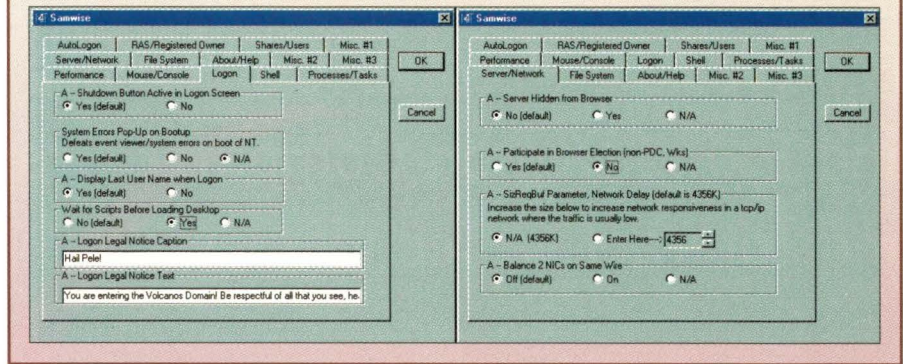

Samwise is another useful freeware utility (written by Bob Friedman). It provides a convenient GUI interface for editing a variety of frequently changed registry keys. Fields controlling the various settings are collected into a series of panels within the utility's main window (illustrated in Figure 2).

The dialog on the left shows login and start-up/shutdown-related settings, including keys controlling whether or not the Shutdown button is enabled in the login dialog box and specifying the title and content text for the optional legal notice dialog box. While the registry settings corresponding to the items on this panel can all also be set via the system policy editor, the same is not true for those in the Server/Network panel shown on the right. Some of the latter settings relate to the manner in which the local system participates in browsing and browser elections, and the Samwise interface provides a very convenient mechanism for modifying them.

Next, we will consider two freeware utilities for assigning user rights from the command line: `grant` (written by Andreas Hansson) and `ntprivs` (written by Michael T. Gercevic). The `grant` utility can list, add or delete user rights, and it has the following syntax:

```
grant action right user-or-group server
```

where *action* is a keyword indicating the operation to perform, *right* is the desired user right and the remaining two arguments indicate the user or group and server upon which the action is to be taken, respectively. The `list` action keyword displays a list of all defined user rights, while the `show` action keyword displays the holders of the specified user right, as in the following example, which displays the holders of backup privilege:

```
>>> grant show SeBackupPrivilege
Accounts with SeBackupPrivilege:
```

```
BUILTIN\Backup Operators
BUILTIN\Server Operators
BUILTIN\Administrators
```

The following command grants this right to user Chavez using the `add` action keyword:

```
grant add SeBackupPrivilege Chavez
```



# All Internet. All Business. All Week.

From advertising to e-commerce to enterprise connectivity, when it comes to putting the power of the Internet to work for business, the possibilities are endless. And only one event puts all the possibilities at your fingertips — Fall Internet World.

Our five-day conference is the best in the industry—covering all the Internet business applications, technologies and trends your company needs to increase performance.

Then there's our exhibit hall—the world's largest display of Internet products, services and systems from more than 600 leading industry suppliers, like Microsoft, IBM, HP, AT&T, Oracle, RealNetworks—all the big names.

And speaking of big names—they don't come any bigger than our keynoters. Five of the industry's most high-powered visionaries will share their insights into Internet's current and future potential for all of us.

Now that the Internet is open for business, make sure your business is open to the possibilities. Come to Fall Internet World '99.

## Our 1999 Keynotes:

**Joseph P. Nacchio**  
Chairman/CEO  
*Qwest Communications  
International Inc.*



**Craig R. Barrett**  
President/CEO  
*Intel Corporation*

**Ivan Seidenberg**  
Chairman/CEO  
*Bell Atlantic*



**Sanjay Kumar**  
President/COO  
*Computer Associates*

THE SEVENTH ANNUAL

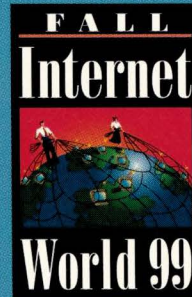

CONFERENCE: OCT. 4-8  
EXHIBITS: OCT. 6-8  
JACOB K. JAVITS  
CONVENTION CENTER  
NEW YORK, NY

### For event information:

Visit: <http://events.internet.com/fall99>  
Call: 1-800-500-1959  
E-mail: [fiwprogram@iw.com](mailto:fiwprogram@iw.com)

### To exhibit:

Call: (203) 341-2969  
E-mail: [smoriarty@iw.com](mailto:smoriarty@iw.com)

Produced by:



Sponsored by:



Show network provided by:



From the E-mail Center  
to the show floor... Are you  
networked for e-business?

Code: N56



Similarly, you can use the `del` action to remove a user right.

The `ntprivs` command can perform similar tasks. For example, the following command removes the backup privilege from user Chavez:

```
ntprivs - Backup Chavez
```

Like `grant`, `ntprivs` accepts a server name as its final argument and, therefore, can operate on either a local or remote system. It also uses more intuitive names for user rights.

The `ntlast` command can display login history data for Windows NT systems (it is freeware written by J.D. Glaser). Its options and arguments allow you to specify the system from which you want information (local or remote) and to limit the display to either successful or failed logins (both are included by default) and/or to a specific user. Its normal output is rather verbose, but the `-c` option limits the display to one line per login (following the style of the UNIX `last` command):

```
>>> ntlast -c
SQL Acct BOREALIS VALA May 21 07:52:46 1999
administrator BOREALIS \\VALA May 21 07:52:44 1999
Administrator BOREALIS VALA May 21 07:52:42 1999
Chavez BOREALIS \\DEMETER May 20 10:39:04 1999
Chavez BOREALIS \\SHEILA May 13 21:08:48 1999
```

In the above example, we can see that user Chavez last logged in to the local system on May 20 from DEMETER, and logged in from SHEILA seven days prior. Note that this command does not distinguish between true interactive logins and those generated by resource usage from a remote system (because Windows NT does not distinguish them either).

The ExitsNT facility (written by Peter van Wingerden) is a freeware tool that adds an icon to the system tray, allowing for one-click system shutdown (the icon image is of a little com-

puter, a choice which is not completely intuitive to me). By default, a single click on the ExitsNT icon initiates an immediate shutdown; fortunately, you can configure the utility to require a double-click instead. Right-clicking on the icon brings up a menu containing shutdown, reboot, powerdown and logoff options, and also provides a means for configuring and exiting from the utility itself.

We will consider utilities designed to recover deleted files as the final item in this next section. Normal Windows NT usage has file deletion occurring through the Recycle Bin, where files are temporarily saved until the user empties the bin manually. However, files deleted from the command line or via programs don't go through the Recycle Bin and cannot be recovered by simply restoring them from it, and neither can items that were removed when the bin was emptied. Furthermore, like many users, I always set the Recycle Bin to immediate delete, so it provides no safeguard at all for me.

The RecoverNT facility from Sunbelt Software (<http://www.sunbelt-software.com>) can sometimes restore deleted files, whether or not they ever went through the Recycle Bin (pricing starts at \$295 for a single system). Its strategy is to examine the entire disk in order to locate whatever files it can, taking a brute-force approach to the problem. Once it has finished, it provides a list of all files currently on the disk and those that can be recovered from unused space. The user interface could be a lot easier to use—for example, it is necessary to scroll through a huge list of files to find the one you want—but the utility does get the job done and I have successfully recovered more files with it than I care to remember.

## Software from Systems Internals

Systems Internals' site (<http://www.sysinternals.com>) offers a variety of extremely useful software, mostly free of charge, by Mark Russinovich and Bryce Cogswell (see "Systems Internals Software" for a list of some of the programs that are

### Systems Internals Software

#### FREE SOFTWARE

**CacheSet:** Sets various Cache Manager parameters.  
**Contig:** Creates contiguous files.  
**CPUmon:** Continuously displays CPU activity data.  
**Ctrl2cap:** Switches Caps Lock and Ctrl keys.  
**Diskmon:** Continuously displays hard disk activity.  
**Filemon:** Continuously displays file system activity.  
**Frob:** Sets scheduler parameters.  
**Handle:** Displays open files by process (command line).  
**HandleEx:** Displays open objects by process.  
**ListDLLs:** Lists loaded DLLs by process.  
**NewSID:** Changes computer system ID (SID).  
**NTFSinfo:** Displays usage information about NT file systems.  
**Pmon:** Continuously displays process creation/deletion activity.  
**Portmon:** Continuously displays serial and parallel port activity.  
**Regmon:** Continuously displays registry-related activity.  
**Sdelete:** Secures file overwriting program.  
**Strings:** Searches Unicode and ASCII strings of binary files.

**Sync:** Flushes disk buffers to disk.

**TCPView:** Displays TCP and UDP connections/endpoints.

**Undelete for Windows NT:** Expands the Recycle Bin to catch files deleted from command prompts and within programs.

**Uptime:** Shows how long a system has been up.

**VolumeID:** Sets disk partition volume IDs.

**Winobj:** An Object Manager namespace viewer.

#### COMMERCIAL SOFTWARE

**FAT32:** Makes FAT32 file systems accessible to Windows NT.

**ERD Commander:** A bootable floppy set for Windows NT giving system access and read/write file system access via 15 or more standard commands. The Professional Edition adds support for striped volumes, password recovery and additional commands.

**NTFSDOS Tools:** A read/write NTFS driver for DOS/Windows (limited file renaming and copying).

**Remote Recover:** Provides access to drives on a dead Windows NT computer across the network.



most germane to Windows NT systems administration). We have space to look at only a few of them here.

We'll begin with a few command-line utilities. The `uptime` command shows how long the local system has been up (in other words, the time since it was last rebooted):

```
>>> uptime
This computer has been up for 0 days,
0 hours, 20 minutes, 49 seconds.
```

This utility performs the same function as the one of the same name available on UNIX systems.

Like `uptime`, `sync` is another UNIX utility that is missing from Windows NT. The version provided by Systems Internals flushes the disk buffers associated with all hard disk partitions by default. You can include its `-r` option to flush the buffers corresponding to removable disks as well, as in the following example:

```
>>> sync -r
Flushing: C D E F G H K
```

As this example illustrates, the utility displays each drive letter as it does its work.

The `contig` command can be used to make an existing file contiguous, which in some circumstances will improve disk I/O performance. For example, the following command will attempt to make the specified library file contiguous (with the command operating in quiet mode):

```
>>> contig -q c:\winnt\system32\vp6r.dll
Contig V1.21 - makes files contiguous
Copyright (C) 1998 Mark Russinovich
http://www.sysinternals.com
```

```
Processing files in silent mode...
```

(Despite Russinovich's brilliance as a programmer and analyzer of Windows NT and other operating systems, he still has a bit to learn about what "quiet" means.) The `contig` utility can also be used to create a new contiguous file of a specified size.

The final command-line utility we will consider here is `strings`, which searches binary files for Unicode or ASCII character strings (again operating in an analogous manner to the UNIX utility of the same name). For example, the following command will search the Windows NT kernel loading utility for Unicode strings:

```
>>> strings c:\ntldr
ScsiAdapter
LastKnownGood
Microsoft(R) Windows NT(TM) Operating System
ProductVersion
4.00
...
```

Systems Internals has also produced a number of useful

**Figure 3. The Filemon Facility**

#	Time	Process	Request	Path	Result	Other
36	9:38:35 AM	CMD.EXE	IRP_MJ_CREATE	K:\Work\Bin\UPTIME.EXE	SUCCESS	Attributes: Any Options: Op...
37	9:38:35 AM	CMD.EXE	IRP_MJ_CLEANUP	K:\Work\Bin\UPTIME.EXE	SUCCESS	
38	9:38:35 AM	CMD.EXE	IRP_MJ_CLOSE	K:\Work\Bin\UPTIME.EXE	SUCCESS	
40	9:38:35 AM	UPTIME.EXE	IRP_MJ_READ*	K:\Work\Bin\UPTIME.EXE	SUCCESS	Offset: 28672 Length: 1536
49	9:38:35 AM	UPTIME.EXE	IRP_MJ_READ*	K:\Work\Bin\UPTIME.EXE	SUCCESS	Offset: 17408 Length: 11264
4313	9:39:34 AM	System	IRP_MJ_CLOSE	K:\Work\Bin\UPTIME.EXE	SUCCESS	

GUI-based system monitoring tools. We'll look at Filemon as a typical example; it is illustrated in Figure 3.

Filemon produces a display of all ongoing operations within the Windows NT file system. Like other utilities of this type, Filemon continuously updates its display, thereby providing the ability to monitor file system activity in real-time. In Figure 3, the `uptime` utility has just been run from the command line, and we see the file access operations performed on its executable image file, which resulted from that command. Systems Internals provides similar facilities for monitoring low-level CPU, disk I/O, registry access and serial/parallel port activity.

Another useful monitoring facility is `HandleEx`, a GUI program that displays file and thread resource usage for a process (see Figure 4, Page 36). Note: Systems Internals' `Handle` and `ListDLLs` utilities provide equivalent command line-based functionality.

The top window illustrates `HandleEx`'s default mode of

## ALPHANUMERIC PAGING FOR UNIX

RELIABLE, EASY DELIVERY OF MESSAGES ANYTIME ANYWHERE

- Email forwarded to pager automatically
- Pages can be generated from scripts, and network monitoring programs
- GUI and command line interface
- Works with any paging service
- Automatic email confirmation, history logs and error reporting
- Client-server technology
- Works with digital and alphanumeric pagers

### Personal Productivity Tools for the Unix Desktop

14141 Miranda Rd  
Los Altos Hills, CA 94022  
Email: [sales@ppt.com](mailto:sales@ppt.com)  
Tel: (650) 917-7000  
Fax: (650) 917-7010  
<http://www.ppt.com>



**Figure 4. The HandleEx Facility**

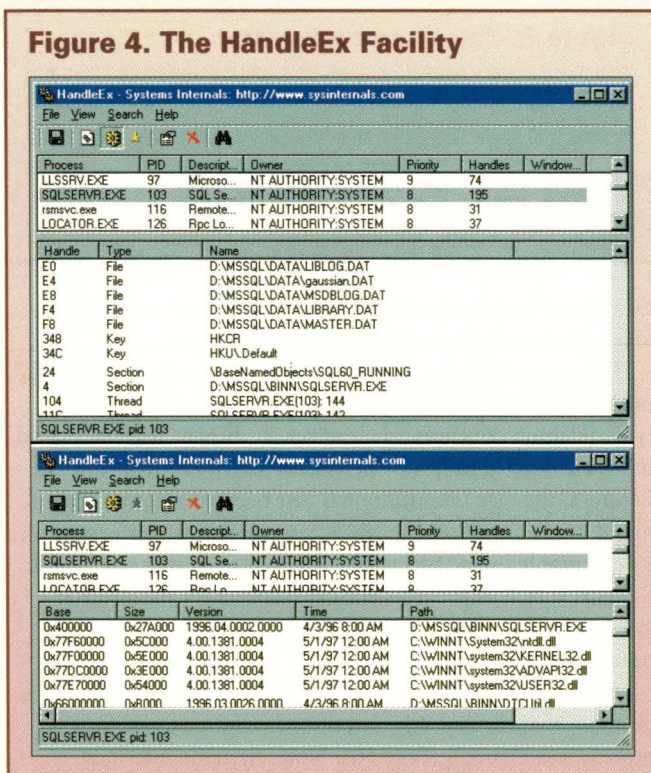

operation: the lower portion of the window displays all object handles associated with the process selected in the window's upper pane. In this case, we are viewing the handles associated with the main SQL Server process (beware the display has been truncated). From this data, we can determine several of the disk files used by the server, two of the registry keys it relies on and some of the threads the process currently comprises.

The bottom window illustrates the utility operating in its other mode: listing dynamic link library (DLL) files associated with a process. Again, this example shows those corresponding to the main SQL Server process.

The Systems Internals site also provides access to the commercial software created by Russinovich and Cogswell; this software is marketed and supported by WinInternals Software and may be purchased via <http://www.winternals.com>. Of its many useful products, ERD Commander is deserving of special mention. This package may be used to create a set of true bootable Windows NT floppy disks; when used, they boot the system into a limited command-line mode from which it can be repaired (similar to a limited single-user mode under UNIX). This command shell provides around 15 commands that can be used to examine and modify a troubled system. The Professional version of ERD Commander adds

support for additional system facilities, such as striped volumes, as well as the `chkdsk` command. Pricing starts at \$249 for the regular version and \$324 for the Professional version (you can upgrade from the regular version to the Professional version for the \$75 difference in price).

When you purchase ERD Commander in either version, what you get is a program that can create these bootable diskettes, not the bootable disk set itself. In order to make the disk set, you must run the program, providing it with a set of standard Windows NT setup disks that it will modify; if desired, it can create a new set of them as it runs. I recommend you choose the latter option rather than modifying your original Windows NT setup disks.

## Windows NT Security Tools

Pedestal Software (<http://www.pedestalsoftware.com>) offers a variety of very useful Windows NT security-related command-line utilities (written by Keith Woodard and Fernando Trias) in a single package. These utilities may be divided into four main classes: file permissions modification tools (including access control lists, or ACLs, file ownership and auditing settings), registry key permissions tools, share permissions tools and a user account utility.

This package, called NTSec for short, is available in two versions (with and without auditing tools); pricing starts at \$15 (nonauditing version) and \$55 (full version) for a single computer system. Some of the most useful are summarized in "NT Security Tools from Pedestal Software." We'll conclude this column by considering a few examples.

NTSec includes several utilities for modifying ACLs. For example, the `listacl` command lists the contents of an ACL, while the `igrant` and `irevoke` commands add and remove specified access for a specific user/group from an ACL, respectively. For example, the first command below gives user Chavez all defined permissions (granted individually) for the file `ntsec.txt`, augmenting whatever permissions she had before. The second command replaces user Wong's current permissions with Read-Execute-Change access:

### NT Security Tools from Pedestal Software

- Listacl:** Displays file permissions and auditing settings.
- Swapacl:** Reassigns file permissions from one user/group to another.
- Igrant, Irevoke:** Grants/revokes file and directory permissions, respectively.
- Swapdomain:** Swaps one domain for another in ACLs.
- Setowner:** Sets file/directory ownership.
- Saveacl, Restacl:** Saves/restores ownership and/or permissions to/from file, respectively.
- Reglistacl:** Displays registry subkey security and auditing settings.
- Reggrant, Regrevoke:** Grants/removes access to registry keys, respectively.
- Regsetowner:** Changes registry key ownership.
- Regswapacl:** Reassigns permissions from one user/group to another.
- Regauditadd, Regauditdel:** Adds/removes auditing settings for registry keys, respectively.
- Auditadd, Auditdel:** Adds/removes auditing on files and directories, respectively.
- NTuser:** Adds/modifies/deletes users, groups and policies.



```
>>> igrant -f chavez:,rwpxd ntsec.txt
>>> igrant -f -replace wong:rpx ntsec.txt
>>> listacl ntsec.txt
C:\Bin\ntsec.txt
  Owner: Administrators (lg)
  Administrators (lg)      (All)
  Everyone                (RWXD)
  SYSTEM                 (All)
  Server Operators (lg)  (RWXD)
  Chavez                  (RWXDOP)
  Wong                    (RXP)
```

The final command lists the contents of the ACL on the same file, and the display verifies that Chavez's and Wong's permissions are as we have just set them.

The command syntax may seem a little strange at this point, but it is easily explained. The `igrant` utility is a general command that can set both file and directory permissions (the `-f` option says to operate only on files). The command's first argument, consisting of a name followed by a colon and two comma-separated permissions sets, specifies the desired directory and file-level permissions. In the above examples, we have left the directory permissions blank because we are concerned only with a file's ACL.

In a similar manner, the `irevoke` command can be used to remove specified permissions from an ACL, using the `-replace` option again serving to overwrite rather than selectively modify any current permissions. For example, the following command takes away Chavez's access to this file:

```
irevoke -f chavez:,all ntsec.txt
```

The `swapacl` command allows you to reassign existing ACL entries from one user or group to another. It can be very useful in circumstances when you need to move permissions from one user to another. For example, the following command reassigns Chavez's permissions to the group `chem` for all the files on drive `d:` (`-r` says to operate recursively):

```
swapacl -r chavez chem d:\*.*
```

Note: The `-clone` option may be similarly used to copy an existing ACL entry without removing the original one.

File ownership may be specified with the `setowner` command. For example, the following command makes user Chavez the owner of all files in the billing subdirectory with the exception of Excel spreadsheet files:

```
setowner -r chavez billing\*.* -x *.xls
```

The `saveacl` and `restacl` commands are used to save the ACLs for a subtree to a disk file and then to reapply them later, respectively. For example, the `saveacl` command below records the ACL for every file in the Windows NT installation directory tree, saving them to the file named `saved_acls`. A subsequent `restacl` command could be used to apply those ACLs to the same files, either on the same system or on a dif-

ferent system—in this way, a standard set of permissions could be easily applied to multiple systems (and automating the process would be very easy):

```
saveacl -r c:\winnt saved_acls
```

By default, the ACL data from the file completely replaces those residing in the file system to which it is applied. However, the `restacl` command can also merge the permissions specified in a file with those already existing on the system via a single option:

```
restacl -mergewithreplace saved_acls
```

The `-mergewithreplace` option says to replace the existing ACL entry with the one found in the specified file, but leaves other entries alone (that is, those for which no entry is recorded in the saved file).

For our final example, we will briefly consider the `ntuser` command designed to create and modify user accounts from the command line. Some of the functionality provided by this command is available via the standard Windows NT `net user` command, but it also provides access to many account attributes, which the latter cannot modify. `ntuser`'s capabilities are illustrated by the following example, which modifies the account for user Chavez (we've placed each option on a separate line for easy readability):

```
ntuser change chavez
-full_name "Rachel Chavez-Vega"
-home_dir //vala/homes/chavez
-home_dir_drive x:
-acct_expires 31/10/99
-set UF_DON'T_EXPIRE_PASSWD
-set RASPRIV_CallerSetCallback
-unset UF_ACCOUNTDISABLE
```

This command sets the user's full name, specifies the location of her home directory, as well as a drive letter to which it should be mapped automatically at login, and sets the expiration date for her account. It also flags her password as never expiring, grants her dial-up system access, allows her to specify a callback telephone number and clears the disabled flag for the account (thereby activating it).

I hope this column has introduced you to some free and modestly priced utilities, which will make systems administration easier and more efficient for your Windows NT system. If you have some similar favorite tools, please feel free to drop me a line about them. ➡

---

***Eileen Frisch** is systems administrator for a very heterogeneous network of UNIX and NT systems. She is also the author of the books *Essential System Administration* and *Essential Windows NT System Administration* (both from O'Reilly & Associates Inc.). In her (almost nonexistent) spare time, she enjoys painting and lounging around with her cats, Daphne, Susan, Talia and Lyta. Email: aefrisch@lorentzian.com.*



# Work

by Jeffreys Copeland and Haemer



*"Once more unto the  
breach, dear friends."  
— William Shakespeare,  
Henry V, III:1*

## I18N, Part 2

Once upon a time—last month, to be exact—we were jarred into discussing internationalization (often abbreviated I18N) by some work Copeland is doing at Softway Systems in preparing its Interix system for UNIX branding. We were explaining the steps you must take to enable your anglophone software to handle characters other than ASCII and languages other than English. On the one hand, it's a cookbook problem because the patterns repeat themselves. On the other hand, we may need to consider our software a little more closely because algorithms appropriate for a character set with 128 elements just won't work for one with 6,400 ideographs. This is an application of the Hawker Observation: You need to seriously rethink the algorithm you're using every time you increase your data set by two orders of magnitude.

To review quickly: In most cases, you read data into your program with each character represented by one or more

bytes. You convert the multibyte characters into the standard C `wchar_t` data type using the `mbtowc()` interface. Then you can process the `wchar_t`s using similar algorithms to your existing ones, but using different interfaces.

### More Character Strings

When we left off last month, we had just finished talking about collating sequences. After that complicated problem, the remaining string-processing interfaces are fairly straightforward.

For example, in the I18N environment—as long as we are sure we have a single-byte character and have called `setlocale()` to set up the language specifics—we can still use the normal macros from `<ctype.h>`. In other words, `islower(ü)` returns true even though `ü` isn't in the ASCII range. But we also have wide-character versions of those same macros defined in `<wctype.h>`. If we have a wide-character `wc` containing that same `u-umlaut`, `iswlower(wc)` will be true. Even `towlower()` and

`toupper()` do the expected thing.

That still leaves us with the interfaces for handling full strings rather than single characters. Again, things work in a reasonable fashion. There are wide-character equivalents for the major string functions defined in `<string.h>`. For example, `wscpy(a, b)` copies the `wchar_t *b` into `a` and returns the pointer to `a`.

This means that if you have a code fragment for assembling a string such as

```
char *result, *whole, *fraction;
strcpy(result, whole);
strcat(result, ".");
strcat(result, fraction);
```

you can now use the analogous

```
wchar_t *result, *whole, *fraction;
wchar_t wradix[10];
char *radix;
wscpy(result, whole);
radix =
    localeconv()->decimal_point;
```



```
mbstowcs(wradix, radix, 10);
wscat(result, radix);
wscat(result, fraction);
```

Notice that the code is not exactly the same. We can't assume that a foreign language uses the same marker for a decimal point as we do in English. The locale-specific radix character is available from the locale as a multibyte string in the `lconv` structure whose pointer is returned by `localeconv()`. Notice also that we're careful about converting the multibyte string to a wide-character string before we append it to our result. (If this was in the inner loop of our program, we'd prepare the wide-character version of the radix outside the loop.)

## Input and Output

It's all well and good to have strings—even strings with European or Asian characters in them—but how can we get them in and out of our programs?

Again, by analogy, we have `%lc` and `%ls` specifiers to `printf` and `scanf`. This lets us print the string we assembled above with a line such as

```
printf("%d %ls\n", n++, result);
```

Notice that `%ls` (or the equivalent `%S`) converts the wide-character string to its multibyte form before writing it. In other words, the multibyte form is the normal external one, and the wide-character version is used for internal processing only. If you think about it, this makes perfect sense. The mapping from multibyte to wide-character is implementation-dependent and may not be portable between systems. For example, while Solaris uses a 32-bit wide-character representation, Interix uses 16-bits, so if Haemer writes a document in Japanese wide-characters on his Sun server, Copeland will be unable to read it from his Interix machine. However, we can easily exchange the document using the Shift-JIS codeset, which is one of the common Japanese multibyte representations.

But how do we get Japanese (or Chinese, or Korean) characters into the computer in the first place? This varies from system to system and isn't covered in any standard. However, in general, there is something called an input method editor, or IME. In rough outline, an IME provides a way to enter a word, which can be translated into an ideograph. In the case of Japanese, we generally have a keyboard with two Shift keys. One shifts from lowercase to uppercase, and the other shifts the keyboard into "kana" mode, which allows the keys to type Japanese phonetic characters, hiragana or katakana. When we enter a word in hiragana, we are then presented with the possible Japanese kanji for that word—remember that there is a many-to-one mapping in Japanese both for words into kanji (the name "Yoshihara" may have several different renditions in kanji, for example) and kanji into words (a given kanji may have several different readings). After we've chosen the correct kanji rendition, it is entered into the file. Again, there is no standard way to do this, so your mileage will certainly vary.

There is one last vital consideration for output. The word order in a given sentence varies from language to language. For

example, "yellow flower" becomes "la flor amarilla" in Spanish. The differences between English and German are equally dramatic. To solve this problem, the standard `printf()` allows the order of the arguments to be handled in variable order in the format string. For example, if we have

```
printf(fmt, month, date, who);
```

we can use an `fmt` of `"%s %d is %s's birthday"` in English to produce "April 26 is James's birthday" and `"%3$s's geburtstag ist %2$d. %1$s"` in German to generate "James's geburtstag ist 26 April." Notice that qualifiers like `2$d` allow us to reorder the parameters to account for word orders in different languages.

## Message Catalogs

Allowing for different format strings is very nice, but how do we provide those in the program? We use the *message catalogs* mechanism, which we'll only cover in outline here.

Catalogs are a collection of text strings that your program loads at runtime, rather than having them stored in the executable itself. Generally, we find the catalogs by using the `NLSPATH` environment variable, which tells the `catopen()` interface where to look for the catalog based on current settings for environment variables like `LANG`. Our program then looks up individual strings with the `catgets()` interface. A typical use is something like

```
printf( catgets(cat,msg_set,msg_id,"%s %d"),
        mon, day );
```

In other words, we look up a particular message in catalog `cat`, and use `"%s %d"` if we can't find it.

In many existing programs, you'll find an amazing variety of syntactic sugar to hide the complicated `catgets()` call. The most common is the `_( "message" )` syntax used in many of GNU's utilities.

One last warning about text strings: You should remember that plurals vary from language to language, so the familiar English fragment

```
printf("%d error%s", n, (n==1)?"":"s");
```

won't work.

Translation of text strings is a complicated process. Whole organizations with the ostensible purpose of internationalization actually spend most of their time providing translation services.

## Time

How to get time values sensibly printed is a real problem, given the different names for months and days of the week, different cultural requirements for formatting dates and different numbering schemes. These problems are all subsumed by the `strftime()` interface. It takes a buffer pointer, a size, a format and a pointer to a `tm` structure, as returned (for example) by `localtime()`, and generates a formatted string into the buffer, returning the length of the result.



The format specifiers for `strftime` are more numerous and every bit as complicated as those for `printf`. However, many of the specifiers will be familiar if you've used alternate formats from the `date` command. For example,

```
strftime(buf, SZ, "%A %d %B %Y", tm);
```

produces "Thursday 7 February 1985." The important point is that if I have `LANG` set to some locale other than `POSIX`, I can just as easily generate a string like "Donnerstag 7 Februari 1985."

One of the added complications for `strftime` is that to meet The Open Group's specifications it must also handle dates based on eras, the best-known example of which is the Japanese imperial date. In Japanese, the year we think of as 1985 is "Shouwa 60," or the 60th year of Hirohito's reign. To produce a date like this, we say

```
strftime(buf, SZ, "%A %d %B %EY", tm);
```

which in a Japanese locale results in "mokuyoubi 7 2gatsu 60 shouwanen," in the appropriate kanji characters. In a locale without information for era dating,

the normal Gregorian year is supplied.

For the inverse problem—I have a string and I need the `tm` structure it represents—we have the `strptime()` interface. It takes as its arguments a buffer and a format specifier similar to those for `strftime`, and fills in the given `tm` with the information it is able to glean about the date from the string.

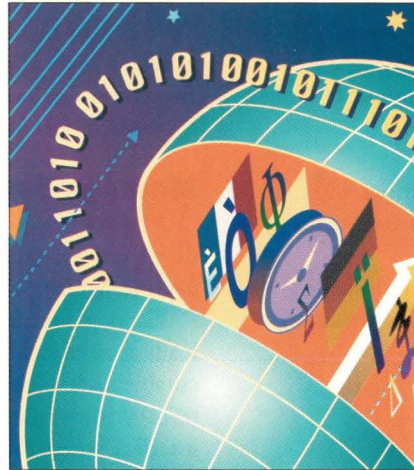

Even more amazing is `getdate()`. While it is not supplied in every system—it's a relatively recent addition to the standards—`getdate` allows us to check a variety of date format strings so that we need not exactly know the

format of the date we're trying to parse a priori. The `getdate` interface performs this magic by referring to a file of possible date formats, and parsing the given buffer based on the first format it finds to match. Different applications can use different date format files based on the `DATETIME` environment variable.

## Numbers and Money

We've talked about the interfaces for character class, collation, strings, messages and time. We haven't yet talked about how we use the `LC_NUMERIC` and `LC_MONETARY` locale categories. Their data is relatively sparse and slightly overlapping.

The `LC_NUMERIC` category tells us what characters to use for the decimal point and thousands separator in the current locale. This allows us to change 1,789.456 in English to 1.789,456 in French. Our old friend `printf` already understands the decimal point, but to make it use the thousands separator, we need to use the `'` modifier. The above number is rendered with a format like `%.3f`.

Similarly, monetary quantities suffer from cultural variations. Many of them

## READER FEEDBACK

To help *Server/Workstation Expert* serve you better, take a few minutes to close the feedback loop by circling the appropriate numbers on the Reader Service Card located elsewhere in this magazine. Rate the following column and feature topics in this issue.

### Features:

- Backup Pros Jump on the SANwagon
- Survey: Networkable UPS Devices
- Product Review: FlashDisk: No Flash in the Pan

### Columns:

- Ask Mr. Protocol—Doom and Death
- UNIX Basics—Just what is that File?
- NTegration—More Useful Tools
- Work—I18N, Part 2
- Java Class—A Tangled Skein

### WebServer Magazine:

- Content Management: Galloping Off in All Directions

### Interest Level

	High	Medium	Low
170.....	171.....	172.....	
173.....	174.....	175.....	
176.....	177.....	178.....	
179.....	180.....	181.....	
182.....	183.....	184.....	
185.....	186.....	187.....	
188.....	189.....	190.....	
191.....	192.....	193.....	
194.....	195.....	196.....	



are handled in the `strfmon()` interface. Like `strftime()`, `strfmon()` takes a buffer and size, a format and arguments, and returns the length of the character data placed in the buffer. The format specifier allows us to decide whether to use the local currency sign (such as a dollar sign) or the international currency name (such as USD), how many digits of pence, cents or pfennigs to include past the decimal point, whether to include thousands separators, what kind of fill characters to use for that check-like look and whether to use a minus sign or parentheses when our checkbook balance looks like the government's.

While numeric and monetary items use similar data, they use orthogonal locale categories because currency may have a different format than other numbers. Also, `strfmon()` doesn't use all the information provided in the locale.

To get the other data, like whether the minus sign precedes the currency symbol or follows it, we can use the data returned by the `localeconv()` interface, which we mentioned briefly above. It returns a pointer to an `lconv` structure that contains all of the data in the `LC_NUMERIC` and `LC_MONETARY` categories. Unless you are in a situation where you absolutely need the raw locale data, you're better off using the provided interfaces, which are (usually) more general and don't depend on the underlying data formats.

## Finishing Up

We've spent two months quickly reviewing internationalization. I18N is a large can of worms, and we've just scraped off the top layer. Think of this as a checklist rather than a tutorial. For the complete story, nothing will substitute for reading the standards and manual pages. The locale chapter in The Open Group's *System Interface Definitions* is particularly useful (see <http://www.opengroup.org/publications> and click on "Common Access to the UNIX Documentation" for an online version).

As usual, we have no clue what we'll discuss next time because there's no telling what problems we'll find interesting in the meantime. But until then, happy trails. =>

**Jeffrey Copeland** ([copeland@alumni.caltech.edu](mailto:copeland@alumni.caltech.edu)) lives in Boulder, CO, and works at Softway Systems Inc. on UNIX internationalization. He spends his spare time rearing children, raising cats and being a thorn in the side of his local school board.

**Jeffrey S. Haemer** ([jsh@usenix.org](mailto:jsh@usenix.org)) works at QMS Inc. in Boulder, CO, build-

ing laser printer firmware. Before he worked for QMS, he operated his own consulting firm and did a lot of other things, like everyone else in the software industry.

Note: The software from this and past Work columns is available at <http://alumni.caltech.edu/~copeland/work> or alternately at <ftp://ftp.expert.com/pub/Work>.



surf boards  
snow boards  
Sun™ boards

We'll service your Sun™ AXi and AXmp systems products so you can spend time doing better things.

We are first to market a complete nationwide on-site service and Solaris™ support program for Sun™ AXi and AXmp products.

We provide: ■ On-site engineers, including 7 x 24  
■ Help Desk, including 7 x 24 ■ Parts-only contracts ■ Solaris™ software support.

Your search for a service provider is over.

Terix is a full-service provider for Sun, SGI™, IBM™ and HP™ workstations and servers.

**TERIX**  
Delivering exceptional service as the rule.

**1-888-84-TERIX**  
1-888-848-3749

Headquarters: 846 Stewart Drive • Sunnyvale, CA 94086 • 408.735.0300 ph. • 408.735.0979 fax  
Sales Office: 4648 Huntwicke Drive • Hilliard, OH 43026 • 614.527.4821 ph. • <http://www.terixcomputer.com>



# Java Class

by Jim Frost

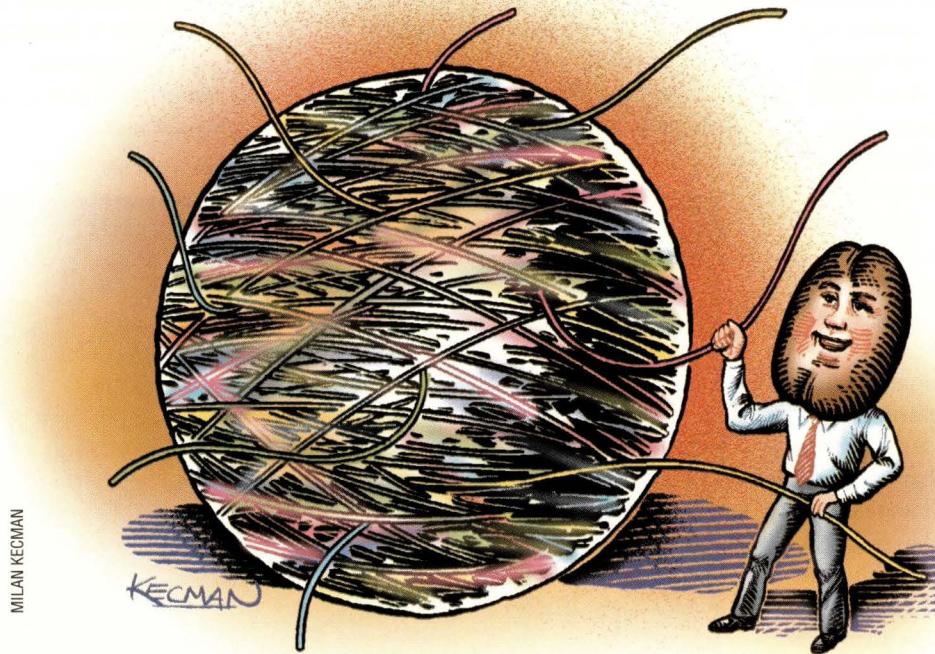

## A Tangled Skein

In last month's column ("At Your Service," Page 44, <http://sw.expert.com/CA/SE.C10.JUN.99.pdf>), we briefly investigated Java threads as a way to manage server load. This month, we're going to step back a little and look at the Java threading model and build some objects that are useful in a multithreaded environment, including a more generic request-handling thread pool.

Java provides an object, `java.lang.Thread`, which is the basic execution context in a program. All program code runs within one or more thread context objects. One thread, the *main* thread, is created by the Java Virtual Machine (JVM) when it starts, and is used to run the `public static main(String argv[])` method that is specified to the JVM.

Any thread may create new `Thread` objects and start them running with the `start()` method. A programmer may either subclass `Thread` and override the `run()` method with her own code,

or supply an object that implements the `java.lang.Runnable` interface (which contains only a single method, `run()`) to the `Thread` object constructor.

Simple programs, such as `Hello World`, use only the main thread. Others, including most servers and GUI programs, spawn a number of threads to perform various duties.

Threads provide two useful capabilities. The first, and best known, is *concurrency*, or the ability to perform (or appear to perform) multiple tasks at the same time. This is particularly useful in computationally intensive operations, such as matrix multiplication or ray tracing on multiprocessors, because it allows more than one processor to be brought to bear on the task.

But more important than concurrency is the ability to handle *asynchronicity*, or the tendency for events to come at unpredictable intervals. Almost every modern program must handle a variety of asynchronous events—everything

from watching for clicks and mouse motion, to handling requests from thousands of simultaneous users.

Unfortunately, in traditional single-threaded applications it is difficult to handle asynchronicity. Usually it's done with one of two techniques: an event-driven model, such as the UNIX signal system or the Windows event dispatcher; or a polled model, where one continually checks a series of input sources in a loop and handles each in turn. In either case, a programmer must set up a framework for determining which input source produced the event and must manually manage the data context for each event source. A typical polled loop would look like the following:

```
for(;;) {
    wait_for_event();
    if (event_1_happened)
        handle_event_1();
    if (event_2_happened)
        handle_event_2();
}
```



# Java Class

This leads to long and often complicated code runs, and has the deficiency that while you're handling an event, nothing else can happen in the system.

In a multithreaded environment, the thread system handles the management of data context and CPU allotment for the programmer. This allows asynchronous events to be managed

using a single context per event source—turning the task into one of several more simple synchronous processors. The example in Listing 1 shows a simple TCP/IP server written in Java using multiple threads.

Because each thread deals with only a single event source, the event-handling loops are very simple: wait for an event,

process it, then wait for another. Each event-handler operates without knowledge of the others. This allows for much shorter and less complicated code runs, which, as we all know, helps to keep the bug counts down.

In Listing 1, the main thread creates the `Server` object around a `ServerSocket` object it has already created. It then starts waiting for clients by calling `handleClients()`. This method loops, waiting for new client connections to the `ServerSocket`. As each is obtained, a new client management thread is spawned to handle data from the client.

Each client management thread has a `run()` method, which simply loops, waiting for data from the client and processing it as it comes in. When there is no more data, the `run()` method returns, allowing the thread to terminate and the thread object to be garbage-collected.

## When Not to Use Threads

When Sun Microsystems Inc. developed Java, one of the basic assumptions was that threads could be created cheaply and used in multitudes. But, as mentioned last month, this is not true of many of today's Java runtime environments. Threads may be expensive to create and have considerable overhead, and on most systems you are limited to a few hundred or thousand in the entire system. Even when threads are cheap and plentiful, extensive use of them can make code slower and more difficult to understand.

One relatively common mistake made by novice Java programmers is to create a new thread to process every button or menu event. They have the right idea; they're trying to make the event processing indepen-

### Listing 1. Server Written Using a Threaded Technique

```
// Server.java

import java.io.*;
import java.net.*;

/** A server class that uses threads to handle client data processing. */
public abstract class Server
{
    /** Socket on which to wait for new clients */
    private ServerSocket serverSocket;

    /** Method that opens a new output stream for a client. */
    abstract OutputStream openClientStream();

    /** Creates a new server object to handle clients. */
    public Server(ServerSocket serverSocket)
    {
        this.serverSocket = serverSocket;
    }

    /** Waits for a client to connect and spawns a thread to handle it. */
    public void handleClients()
    {
        try {
            for (;;) {
                Socket clientSocket = serverSocket.accept();
                new ClientThread(clientSocket);
            }
        } catch (IOException e) {}
    }

    /** Inner class that defines a client-handling thread. */
    class ClientThread extends Thread
    {
        private Socket clientSocket;

        /** Creates a new thread object to handle the given client socket. */
        ClientThread(Socket clientSocket)
        {
            this.clientSocket = clientSocket;
            start(); /* Start running immediately */
        }

        /** Main method for the thread. */
        public void run()
        {
            try {
                InputStream in = clientSocket.getInputStream();
                OutputStream out = openClientStream();
                byte[] buf = new byte[1024];
                for (;;) {
                    int bytesRead = in.read(buf);
                    if (bytesRead <= 0)
                        break;
                    out.write(buf, 0, bytesRead);
                }
                in.close();
                out.close();
                clientSocket.close();
            } catch (IOException e) {}
        }
    }
}
```



dent of the GUI. The problem with this technique, however, is that most GUI events are handled very quickly; the overhead of creating and starting a thread, or even of handing the event off to a thread that has already been created, dwarfs the actual processing done by the thread. Worse, the code gets longer and more complex as a result of the many thread objects, and it is often difficult (or even illegal) for multiple threads to work with GUI elements safely. This technique is a recipe for disaster. Except in rare instances, you should use the GUI event-processing thread to handle the events.

A good rule of thumb is to use threads every time you have a discrete input source to handle or whenever you need a long-duration activity to take place at the same time as other processing (for example, background calculations in a spreadsheet). Otherwise, it's best to leave them alone.

## Controlling Concurrency

In almost all threaded applications multiple threads have to act on shared data, or must coordinate their actions. To do this they need a way to avoid stepping on each others' toes. Java provides two mechanisms for this coordination: *synchronization* and *notification*.

Synchronization allows the programmer to define a method or code block that can only be executed by one thread at a time. Any other thread that comes along while the first is running must wait until the first thread leaves the synchronized block. Furthermore, Java guarantees that when a thread exits a synchronized block, all data modifications made within that block are available to all other threads (necessary for cache coordination on multiprocessors).

Java uses a primitive synchronization object known as a *monitor*, which may be used either implicitly (by a synchronized nonstatic method) or explicitly (by a synchronized code block). Every Java object instance has its own monitor.

A synchronized method in Java is written as

```
public synchronized void method()
{
    // ... do something ...
}
```

When this method is called, its object instance's monitor will be acquired and all other threads that try to call the method will stall. When the method returns, it releases the monitor, allowing one waiting thread (if any) to enter the method.

Synchronized code blocks are more flexible; they specify the particular object instance whose monitor is to be used. For example,

```
Object o = new Object();
synchronized (o) {
    // ... do something ...
}
```

Why do you care? Because if two threads attempt to modify the same data at the same time it can have unexpected consequences. Consider the following code

```
i = i + j;
```

This code is processed in a series of discrete processor steps. First, the value of *i* is loaded from memory and put into a register. Then, the value of *j* is loaded from memory and put into a register. Next, the two are added together. Finally, the new value is put back into memory. (The JVM is defined as a stack-based processor, rather than register-based, but the process is essentially the same.) If two threads are running this code at the same time, both may load the same values from memory, add them and save the new value back to memory—leaving a value of *i + j* rather than *i + (2\*j)*, as was desired.

To make the code sequence atomic, you must wrap it in a synchronized block:

```
synchronized (this) {
    i = i + 2;
}
```

Now, the second (or third, or fourth...) thread must wait until the first has completed the operation. They operate in lock-step, avoiding each other.

Informed Java programmers will know that Java guarantees atomic update of all basic data types except `long` and `double`. This negates the necessity of synchronizing around individual member assignments in order to preserve data integrity; it isn't possible for the data to be corrupted by two threads making assignments concurrently, or by one reading a value while another is assigning it. Many people take this as a license to avoid synchronization in simple `get()` and `set()` methods, but this has a risk. Unsynchronized data updates may take a while to propagate to all threads when running on a multiprocessor. Synchronization ensures not only integrity, but consistency as well. Except in rare instances, it is best to synchronize around data elements that may be modified. This comes with a small performance penalty, but on modern JVMs (such as the Sun Java 2 production JVM), this penalty is minimized.

Notification, the other way for threads to coordinate their actions, simply allows one or more threads to wait until another tells them it's OK to proceed. Every Java object provides three methods to accomplish this: `wait()`, `notify()` and `notifyAll()`. The `wait()` method simply stops the thread until some other thread tells it to start. The `notify()` method tells one, and only one, waiting thread that it is time to start. The `notifyAll()` method tells all waiting threads it is time to start.

Because these methods must operate in lockstep, they require that their object's monitor be held when they are called. While inside the `wait()` method, the monitor is released; it is reacquired immediately upon waking up. In addition, the `wait()` method may be interrupted by the `Thread.interrupt()` method. While this is rarely done, Java requires that the `InterruptedException` be caught, just in case.

Most other multithreaded languages provide additional thread synchronization mechanisms, including the *mutex* and *semaphore* constructs. These may be implemented easily using the primitives that Java provides, but it is commonly consid-



ered a weakness in Java that it does not provide these synchronization objects. Doug Lea, author of the excellent *Concurrent Programming in Java: Design Principles and Patterns* (published by Addison-Wesley Publishing Co., 1997, ISBN 0-201-69581-2), provides a set of thread synchronization primitives for Java in his `util.concurrent` package available at <http://gee.cs.oswego.edu/dl/classes/EDU/oswego/cs/dl/util/concurrent/intro.html>. I strongly recommend Lea's book and package to all Java programmers.

In practice, however, these other objects are not needed all that often. Rather, most code has one of two requirements: mutual exclusion (provided by synchronization), or the ability to hand data to another thread or set of threads for processing. The latter is easily accomplished with a queue—a list of objects any number of threads may add to and any number of other threads may remove from, in order.

Listing 2 illustrates a simple queue class written in Java.

## Listing 2. A Simple Queue Class

```
public class Queue
{
    private QueueItem head, tail;
    int waiting;

    /** Puts a new data object into the queue. */
    public synchronized void put(Object datum)
    {
        QueueItem item = new QueueItem(datum, tail);
        if (head == null)
            head = item;
        tail = item;
        if (waiting > 0)
            notify();
    }

    /** Retrieves the next data object from the queue. */
    public synchronized Object get()
    {
        if (head == null) {
            waiting++;
            try {
                wait();
            }
            catch (InterruptedException e) {}
            waiting--;
        }
        Object datum = head.datum;
        head = head.next;
        if (head == null)
            tail = null;
        return datum;
    }

    /** Class which holds a queue item. */
    static class QueueItem
    {
        Object datum;
        QueueItem next;

        QueueItem(Object datum, QueueItem prev)
        {
            this.datum = datum;
            if (prev != null)
                prev.next = this;
        }
    }
}
```

It also illustrates the practical use of most of the Java thread coordination primitives. In this queue implementation, there are just two public methods: `put()`, which adds an object to the queue, and `get()`, which removes one.

Because `get()` and `put()` perform a number of discrete operations that must be done atomically (for example, update the `head` and `tail` members of the class, and check or modify the `waiting` member), they are each declared synchronized. This ensures that no matter how many threads are competing to add or remove objects, they cannot mix each other up.

When a thread adds a new object to the queue using `put()`, a new queue item is created and added to the end of the list. That makes it available for another thread to acquire using the `get()` method. It is possible, however, that a thread is already waiting for an object. In this case, the `waiting` member will be greater than zero, and the `put()` method wakes up the thread by calling `notify()`.

When a thread tries to obtain the next object in the queue by calling `get()`, it first checks to see if there are any objects in the queue. If not, it increments the `waiting` member to indicate there is a thread waiting for an object, then calls `wait()`. When it is awoken by `put()` (called from another thread), it decrements the `waiting` member to indicate it is no longer waiting for an object. At this point, there will be at least one object in the list. This object is removed from the list and returned.

Last month, we used a thread pool to control the number of concurrent requests being handled by a server. The same design can be used with a queue. Rather than having each individual thread call `Socket.accept()`, simply call `Queue.get()`. One or more other threads can feed requests to the thread pool using `Queue.put()`.

In some cases, it may be useful to push off processing to some other thread to handle whenever it has the time, effectively introducing asynchronicity. In a typical server, for instance, requests are logged to a file for later perusal. It is not strictly necessary for the client to wait while the request is logged, however. One way to avoid the wait is to put log requests into a queue and have a log-request-processor thread remove them and write them to a file. This allows the client to get its response faster and allows the server to update the log as it has the time to do so.

We've covered a lot of ground this month, including a number of very important concepts that you need to understand to work effectively with Java. Next month, we'll start to take a look at the features Java provides for building client/server applications by investigating the Remote Method Invocation (RMI) package, Java's version of Remote Procedure Call (RPC). ➡

---

*Jim Frost is a software engineer specializing in Java technologies and strong opinions. He may be reached by email at [jimf@frostbytes.com](mailto:jimf@frostbytes.com).*



# BACKUP PROS JUMP ON THE SAN WAGON

It seems almost every backup vendor is hard at work testing the latest storage area network configuration. Is it time you jumped on the SAN bandwagon?

by Alexandra Barrett

**A**nyone involved in a business whose storage needs are continually on the rise can appreciate the coming of storage area networks, or SANs, because they will reportedly allow you to effortlessly add storage capacity to the data center, and manage it with unprecedented ease.

For anyone involved in backing up that data center, though, the thought of adding more storage capacity sends waves of panic coursing through your body. That's because while the modern enterprise's capacity for more storage seems to grow ad infinitum, the amount of time IT professionals have for completing backups is at best standing still, or more likely, getting smaller.

While adding more storage certainly can't help a backup predicament any, a SAN, implemented correctly, can actually go a long





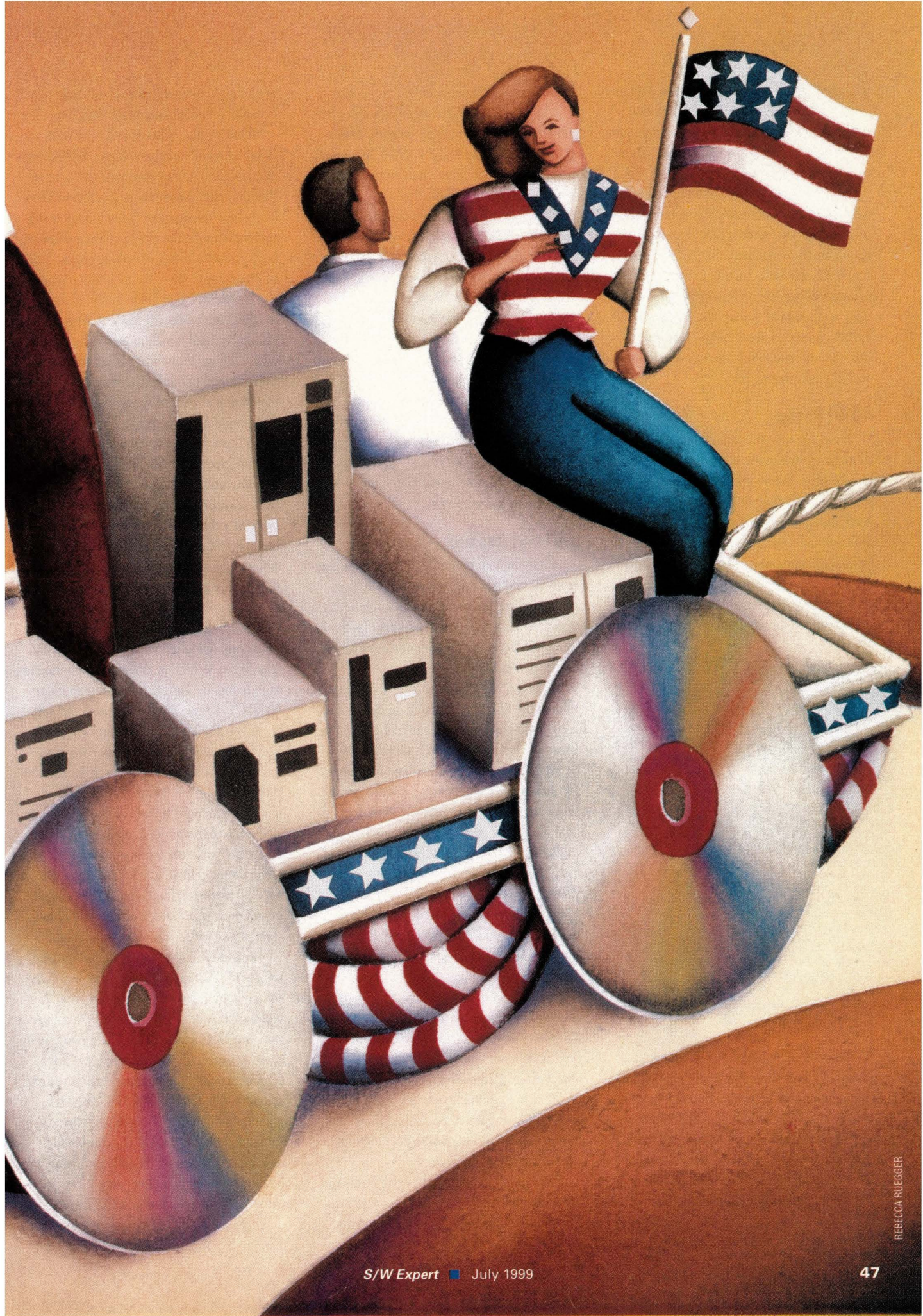



way to easing your backup woes, experts say. In a few cases, SANs can actually decrease the amount of time it takes you to do backup. And, in most cases, they can save you money.

Granted, there isn't an incredible wealth of successful SAN implementation stories out there; SANs are still very much in their infancy. But in the next six to 12 months, more and more SAN pilots will begin to move into production and, at that point, the industry will be ready to see if SAN vendors can corroborate their claims of faster and cheaper backup.

## A SAN Recap

First, for anyone out there who's had their head in the sand for the past year, let's briefly review what a SAN is. A storage area network, as the name suggests, is a network of storage devices. Whereas a local area network, or LAN, links together computers, printers and the like, a SAN connects RAID arrays, CD-ROM towers and backup devices such as tape libraries.



*With full native Fibre Channel support, ADIC's Scalar 218FC is said to be the industry's first tape library to take complete advantage of the increased bandwidth, scalability and data transfer rates associated with Fibre Channel SANs.*

However, the SAN environment is made up of a whole lot more than just storage devices. Usually (but not necessarily) based on Fibre Channel technology, to make a SAN complete you also need Fibre Channel host bus adapters, hubs and switches, and SCSI-to-Fibre Channel bridges for connecting to SCSI-based tape libraries. Together, these elements can begin to form the

backbone of the contemporary SAN.

Among Fibre Channel's virtues is its 100-MB/s performance—slightly faster than Ultra Wide SCSI 2 (80 MB/s) and a full five times faster than the pervasive 20-MB/s Fast Wide SCSI 2.

But perhaps the most important benefit Fibre Channel brings to the table is the flexibility that comes with networking. A Fibre Channel SAN can support up to 126 devices on a single Fibre Channel arbitrated loop (although in practice that is rarely done). And in forthcoming switched topologies, it will be possible to have full 100-MB/s pipes to each individual device on the SAN. In addition, optical fiber cabling can run up to 10 kilometers, or 6.2 miles, which should make it easy to create remote mirrors of your data across campus or across town.

## SAN and Backup

First, let's define the problem. When it comes to backup woes, the issue is too much data, too little time. A SAN, vendors assure us, can help you back up your data in that ever-decreasing backup window.

"Data growth has gotten to the point where the process of backing up to a central backup server is broken because there is simply too much data," says Scott McIntyre, business line manager for storage networking at Legato Systems Inc., a storage software vendor based in Palo Alto, CA. Networks are buckling under the load of backup traffic and backup servers are doing everything they can to keep up.

Backing up individual servers to dedicated tape libraries is still an option, but this approach has several downsides. First, purchasing a tape device for each server you need to back up can get pretty expensive, pretty fast. Second, managing umpteen different tape devices can also be a real headache. Third, in a direct-attached configuration, the servers you are backing up are stuck devoting precious CPU cycles to backup chores when they could be doing something much more productive.

Ultimately, your goal as the backup guru should be to "off-load servers and the network from housekeeping tasks," says Legato's McIntyre. "You didn't buy

your Oracle server to do backups, you bought it to manage your database."

As separate, high-speed networks devoted to all things storage, SANs, vendors assure us, can give you the best of both worlds: the management and flexibility of backup over the network without sacrificing the performance of local backup, which has people excited. "Most of the people who do backups are network-fluent," says Britt Terry, director of marketing at Spectra Logic Corp., a tape library vendor headquartered in Boulder, CO. "They know what happened when they started using hubs, switches and routers, and they're thinking, 'Oh Boy. This is going to be great.'"

Of course, the ways in which SANs will be great for your backup process depend upon your current configuration. Coming to a SAN from a local backup perspective, the most obvious benefit will be your newfound ability to assign idle tape devices to backup servers to which they are not directly attached. In the current SCSI-dominated world, SCSI tape libraries are almost always permanently attached to their disk drives, says Steve Whitner, director of marketing at Advanced Digital Information Corp. (ADIC), a tape library and storage software vendor based in Redmond, WA. So if a tape library is busy performing backup, say, six hours a day, it is unoccupied for the remaining 18 hours. But if that same tape library is hooked up to a SAN, other servers can use it for the entirety of the time it would sit idle. Ultimately, taking a SAN versus local backup approach will mean fewer tape libraries to purchase and better utilization of the ones you already have.

However, if you're thinking about taking a SAN rather than direct-attached approach, be careful not to buy into vendor claims of increased performance, warns ADIC's Whitner. The assumption among potential SAN buyers is Fibre Channel's 100-MB/s data transfer rates outpace Ultra Wide SCSI's 40-MB/s and, therefore, it will take less time to do backup over a SAN than it would to a direct-attached SCSI tape library. "The reality is that they may have no more backup speed at all," Whitner says.

In fact, according to Spectra Logic's Terry, "If you've been doing things cor-



# does your storage system have enough **FIBRE?**

FIBRE CHANNEL DELIVERS

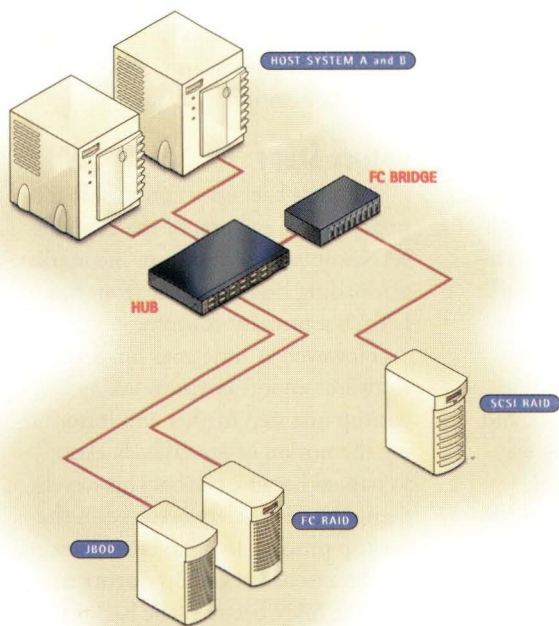

## CONSAN IS THE TECHNICAL DISTRIBUTOR OF CHOICE FOR FIBRE SAN SOLUTIONS.

Consan sales reps and technicians have the knowledge and experience to recommend proven Fibre Channel storage configurations for your specific needs.

We carry the top names in Fibre Channel SAN hardware and software such as IBM's family of Ultrastar™ fibre channel hard drives—available in 9, 18 and 36GB capacities. Consan ensures every solution is engineered to meet or exceed your expectations—from simple plug-and-play storage subsystems to custom configured RAIDs and jukeboxes.

To leverage the most of your existing and new storage technologies while increasing speed and data integrity—call Consan—the authority on Fibre SAN Solutions.

**1.800.221.6740**



**CONSAN**  
A GATES/ARROW Company

18750 Lake Drive East  
Chanhassen, MN 55317  
TEL: 800-229-3475  
FAX: 612-949-0453  
[www.consan.com](http://www.consan.com)

Circle No. 29



# Backup Strategies

rectly, Fibre Channel shouldn't make your backups any faster or any slower." That's because in a direct-attached configuration, it isn't SCSI that's the bottleneck. Instead, the gating factor in a direct-attached backup configuration is the data transfer rate achieved by the tape device, not the wire speed, Terry says.

But, if you're looking at SANs from the vantage point of an organization that does its backups over the network, a SAN's strong point is its performance. In a network configuration, the data to be backed up must first move over the user network to the backup server, which prepares it for backup, and then back over the network to the tape library. In contrast, with a SAN, data never travels over the user network, but moves between primary storage, the backup server and the tape library via its own, dedicated network. At no point are end users impacted by your backup duties.

Taking the backup data off the user LAN and putting it onto the SAN is usually referred to as LAN-free backup and is commonly touted as one of the most immediate benefits you'll achieve by implementing a SAN.

Finally, one aspect of SAN backup that everyone can appreciate is the high availability it brings. With the availability of Fibre Channel switches, from Brocade Communications Systems Inc., San Jose, CA, for example, it's entirely possible to have redundant paths to your data. Also, with the cable lengths afforded by Fibre Channel, it would not be inconceivable that you would want to mirror your backups remotely—the ultimate in data availability, says Shaun Walsh, director of product management for SAN and network-attached storage (NAS) systems at ATL Products Inc., a tape library vendor based in Irvine, CA. "Backup is people's insurance policy," says Walsh. "If it doesn't run, its value goes out the door. Availability is definitely a reason people will buy SANs in the future," he says.

## Who's Doing It?

When it comes to backup software that supports SAN environments, it's no surprise to find that the vendors with SAN offerings are those that cater to the market that's implementing SANs in the

first place: the "enterprise" segment.

"Most people implementing SANs are at the high end of the market," says Kevin Liebl, vice president of marketing for MTI Technology Corp., a storage vendor based in Anaheim, CA. "That's because they've already reached their pain threshold. SCSI technology just isn't keeping up with the performance and scalability that they need."

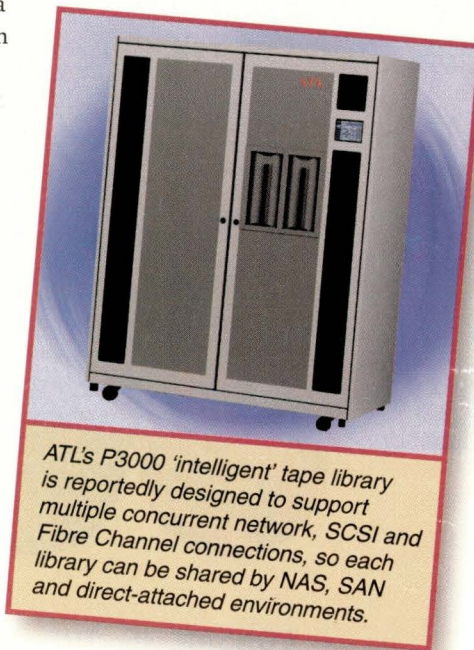

In the UNIX world, therefore, we recognize two big names in the SAN-capable space: Legato, with its NetWorker backup software and SmartMedia storage management suite; and Veritas Software Corp., Mountain View, CA, with its SAN-capable NetBackup, Hierarchical Storage Manager (HSM) and Media Librarian products.

Also, on the Windows NT end of things, both Seagate Software Inc., Scotts Valley, CA (whose Network and Storage Management Group is soon to be subsumed into Veritas), and Computer Associates International Inc., Islandia, NY, offer SAN-capable backup products. Seagate's is called Backup Exec with Shared Storage Option, while Computer Associates offers an Enterprise Library Option for ARCserveIT, its own storage management suite.

Other backup software vendors are reported to be working on SAN solutions, but have yet to ship any products. Contenders include Sterling Software

Inc., Dallas, TX, which recently acquired the Alexandria backup software package from Spectra Logic (it is now called SAMS:Alexandria); and IBM Corp., Armonk, NY, whose SAN products will fall under the Tivoli Storage Management umbrella, and not Adstar Distributed Storage Manager (ADSM), as they have in the past.

This relatively small number of available SAN backup solutions is a testament to the radical shift in thinking that SANs force backup software vendors to make. "In the backup software world, when you begin assuming that you're working with a SCSI device, you're assuming that you have a dedicated connection," says ADIC's Whitner. But when suddenly a drive can float around between hosts, as it can in a SAN environment, that's a totally foreign concept, he says.

In general, backup software vendors gain control of which backup server gets the tape device and when through one of two basic mechanisms, explains Glen Simon, product manager at Seagate Software. One approach is for the backup software to send the tape device standard SCSI "reserve/release" commands, which lock out other servers from writing to the drive. Another approach is to dedicate a "traffic cop" server that owns the library's robotic arm, and handle device contention that way.

## Future Steps

As far as backup is concerned, it's pretty safe to say that of the available SAN software solutions on the market, off-loading backup traffic from the LAN is a primary concern.

However, as time goes on, SAN software vendors envision taking SAN backup one step further and introducing the notion of serverless backup, so named because the backup servers themselves are barely involved in the backup process. In a serverless backup, the data to be backed up doesn't travel over the SAN between the backup server and the tape library, like it does in LAN-free backup. Instead, the backup server sends a copy command to the third-party storage array, which initiates the backup directly to the tape device.

At the forefront of the push toward serverless backup technology is Legato,





## DON'T SURRENDER. BACKUP IS ON THE WAY.

In this battle, the stakes are high. Protecting your company's most valuable asset - its data - is a daunting challenge. Even a temporary loss of access can impact your bottom line. That's why you need Datalink. For over ten years, we've partnered with companies like yours to store, access and protect business-critical information.

With Datalink, you get the best combination of hardware, software and services. Plus an essential ingredient: insight. **Insight that comes from over a decade in the IT trenches.** And hundreds of repeat customers. Put down the flag and pick up the phone. It's time to call in the reinforcements: Datalink. To learn more, call 1-800-448-6314 or visit [www.datalink.com](http://www.datalink.com).

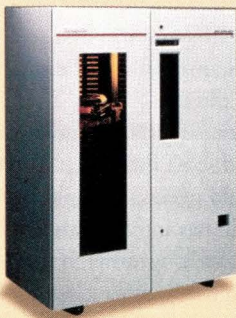

### Your Best Backup

For unrivaled speed (data transfer rate: 10MB/sec) and access (time to first file: 13 seconds) Datalink offers the **StorageTek TimberWolf 9710** tape library-configured with 9840 drives





which demonstrated preliminary serverless backup capabilities at the NetWorld+ Interop show held in Las Vegas in May. Two software solutions manage the transaction: NetWorker provides management facilities, while a Celestra power agent drives an extended copy command embedded in a SAN storage device and instructs it to move data directly from disk to tape.

This approach, Legato says, has several advantages. By not having the server in the data path, users gain server resources like CPU cycles, memory and I/O bandwidth. Data management, meanwhile, is centralized, that is, users are never locked out from their data.

Legato took a leading position in the

serverless backup race this spring, when it acquired Intelliguard Software Inc., Dublin, CA, which originally developed the Celestra architecture. Celestra makes heavy use of the Network Data Management Protocol (NDMP), developed jointly by Intelliguard and NAS array vendor Network Appliance Inc., Santa Clara, CA, to specifically address the issue of serverless backup.

For Veritas customers, meanwhile, serverless backup appears to be a good ways down the road. The company outlines three phases to its SAN strategy and estimates that serverless backup will become a reality in Phase Three, sometime well after 2000. Veritas is waiting on third-party copy specification from

the Storage Networking Industry Association (<http://www.snia.org>), a consortium of 98 companies dedicated to developing standards for the SAN marketplace. "We don't want to be proprietary," says John Maxwell, director of product management for backup solutions at Veritas.

Software vendors aren't the only ones who have a lot of work ahead of them to deliver serverless backup, so do storage and tape library vendors, who must embed the various vendors' serverless backup modules within their firmware. "We've been busy partnering with virtually everyone that's out there," says ATL's Walsh of his company's quest to work in as many different SAN configurations as possible.

## Companies Mentioned in this Article

### **Advanced Digital Information Corp. (ADIC)**

11431 Willows Road N.E.  
P.O. Box 97057  
Redmond, WA 98073  
<http://www.adic.com>  
**Circle 125**

### **ATL Products Inc.**

101 Innovation Drive  
Irvine, CA 92612  
<http://www.atlp.com>  
**Circle 126**

### **Brocade Communications Systems Inc.**

1901 Guadalupe Pkwy.  
San Jose, CA 95131  
<http://www.brocade.com>  
**Circle 127**

### **Computer Associates International Inc.**

1 Computer Associates Plaza  
Islandia, NY 11788  
<http://www.cai.com>  
**Circle 128**

### **Exabyte Corp.**

1685 38th St.  
Boulder, CO 80301  
<http://www.exabyte.com>  
**Circle 129**

### **Hewlett-Packard Co.**

3000 Hanover St.  
Palo Alto, CA 94304  
<http://www.hp.com>  
**Circle 130**

### **IBM Corp.**

Contact local sales office  
<http://www.ibm.com>

### **Legato Systems Inc.**

3210 Porter Drive,  
Palo Alto, CA 94304  
<http://www.legato.com>  
**Circle 131**

### **MTI Technology Corp.**

4905 E. La Palma Ave.  
Anaheim, CA 92807  
<http://www.mti.com>  
**Circle 132**

### **Network Appliance Inc.**

2770 San Tomas Expressway  
Santa Clara, CA 95051  
<http://www.netapp.com>  
**Circle 133**

### **Seagate Software Inc.**

920 Disc Drive  
Scotts Valley, CA 95067  
<http://www.seagatesoftware.com>  
**Circle 134**

### **Spectra Logic Corp.**

1700 N. 55 St.  
Boulder, CO 80301  
<http://www.spectrallogic.com>  
**Circle 135**

### **Sterling Software Inc.**

300 Crescent Court, Ste. 1200  
Dallas, TX 75201  
<http://www.sterling.com>  
**Circle 136**

### **Veritas Software Corp.**

1600 Plymouth St.  
Mountain View, CA 94043  
<http://www.veritas.com>  
**Circle 137**



## Precautions

One thing is certain: SANs are still young. Consequently, the one mantra repeated over and over by vendors and analysts alike is simply: don't attempt to build a SAN yourself. The chances are high that it simply won't work.

That's because with SANs being so new, vendors have not yet had a chance to fully develop their products, much less work out interoperability issues.

SAN products, for example, often suffer from immature components. For example, many first-generation SAN products relied on Palo Alto, CA-based Hewlett-Packard Co.'s Tachyon chipsets, which only implemented low-level SAN functionality. Higher level functionality, consequently, was left to vendors themselves to implement. And so, not surprisingly, "everyone implemented things a bit differently," causing a host of interoperability issues, says Spectra Logic's Terry.

The immaturity of the Fibre Channel specification, too, is often blamed for SAN shortcomings. "SANs are very much tied to Fibre Channel technology," says Seagate's Simon, "and so where Fibre Channel is at is the state of the SAN market."

But just because SAN technology is relatively new doesn't mean that interested parties should necessarily hold off. "Even SCSI still has interoperability issues," says ADIC's Whitner, but no one hesitates to use it.

The key to a successful SAN solution,



# Backup Strategies

vendors insist, is a vendor-certified solution. "A SAN isn't the kind of solution you can just buy through a catalog and expect it to work," says MTI's Liebl. "[You're] better off working with a solution provider."

MTI, mainly a primary storage vendor, for example, will not only provide you with your RAID array, but also tape libraries, SAN networking components and software, which MTI OEMs from its SAN partners.

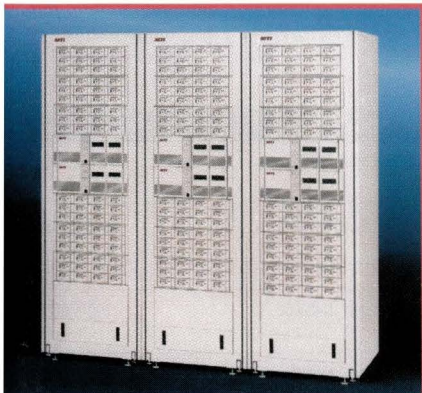

MTI's enterprise RAID storage systems, including the Gladiator 3500 above, for high-availability, high-performance Ultra SCSI/Fibre Channel environments boast Scalable Modular Architecture (SMA) technology, which is said to offer a new degree of flexibility by separating the RAID processor from the disk storage.

Indeed, some vendors will not sell a SAN component without consulting services. "We insist that our professional service people install and configure our systems," says ATLS Walsh. "In a mature market, you can just assume that things work, but with SANs, there's still an awful lot of voodoo going on," Walsh says.

In fact, it seems most players in the industry are hard at work testing various software and hardware SAN configurations. "The SAN certification process has consumed us for the past six months," says Veritas' Maxwell. "We've been methodically going through various scenarios, and checking to see if everything is properly configured." The upshot of Veritas' certification efforts was the so-called "SAN Hot Spot" at NetWorld+Interop, where 19 SAN component vendors demonstrated interworking products.

One of the best places to start researching your SAN is with your existing storage vendor. Chances are, if they have a SAN strategy at all, they have already devised a list of compatible products. If, for example, you use Mammoth 8mm tape libraries from Exabyte Corp., Boulder, CO, your next step should probably be to contact those vendors taking part

in the company's NetStorM SAN initiative, announced in May.

All of which, taken together, says MTI's Liebl, suggests that it is safe to proceed, "but proceed with caution." ⇐

Alexandra Barrett is a Massachusetts-based freelance writer specializing in computer industry topics.

## THE MOST IMPORTANT IMAGES OF THE 20<sup>TH</sup> CENTURY ARE BACKED-UP ON QUALSTAR TAPE LIBRARIES.

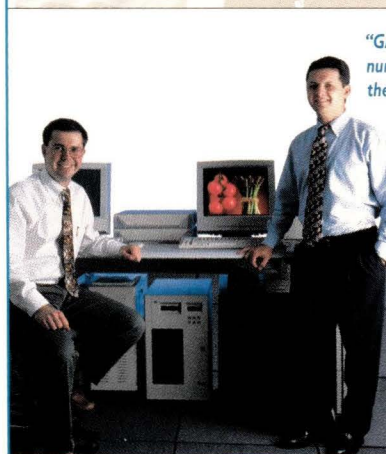

"GA Communications is responsible for managing the digital assets of numerous Fortune 5000 companies and with this responsibility comes the necessity for unflinching backup and archival storage. After testing other backup systems we chose the Qualstar tape libraries because of their reliability, quality and first rate customer service. It has proven to be an excellent choice for us and our clients"

Marc Konic Technology Director, GA Communications

We couldn't have said it better ourselves. Call today and discover why the leading IT Professionals worldwide are choosing Qualstar.



TEL: (818) 592-0061 • FAX: (818) 592-0116  
E-MAIL: sales@qualstar.com • WEB: www.qualstar.com

1-800-468-0680

QUALSTAR®

AIT is a registered trademark of SONY.

Circle No. 21

SIMPLY RELIABLE

The Tape Library Experts



# A SAMPLING OF

# NETWORKABLE UPS DEVICES\*

Compiled by **MAUREN MCKEON** (based on information supplied by the vendors)

\*All products listed can be controlled remotely over a network through an IP connection.

### Key

VA = Volt-ampere  
msec = Millisecond  
Y = Yes  
N = No  
N/A = Information not available

Company address model	Product category	Output connections	Efficiency in normal mode (%)	Typical transfer time (msec)	Battery runtime @ maximum load/ Battery runtime @ 300VA (in minutes)	Hot-swappable batteries utilized	Platforms supported	Price (\$)
<b>American Power Conversion, 132 Fairgrounds Road, West Kingston, RI 02892, <a href="http://www.apcc.com">http://www.apcc.com</a>. Circle 200</b>								
<b>Smart-UPS Tower 700-3000VA (5 models)</b>	Line-Interactive	4-8	96	2-4	5-10/20 (700VA model)	Y	Windows 95/NT, SCO, Linux, NetWare	499-2,599
<b>Smart-UPS RM (rack-mount) 700-3000VA (5 models)</b>	Line-Interactive	6-8	96	2-4	5-10/20 (700VA model)	Y	Windows 95/NT, SCO, Linux, NetWare	649-2,049
<b>Smart-UPS XL &amp; RMXL 700-3000VA (6 models)</b>	Line-Interactive	6-8	96	2-4	8-215/51 (700VA model)	Y	Windows 95/NT, SCO, Linux, NetWare	799-1,885
<b>Smart-UPS T Series 1400-5000VA (8 models)</b>	Line-Interactive	5	96	2-4	8-215/41 (1400VA model)	Y	Windows 95/NT, SCO, Linux, NetWare	1,999-3,950
<b>Best Power, P.O. Box 280, Necedah, WI 54646, <a href="http://www.bestpower.com">http://www.bestpower.com</a>. Circle 201</b>								
<b>Patriot Pro II 400VA</b>	Line-Interactive	4	95	4	7/10	Y	DOS, NetWare, OS/2, Windows 3.1/95/98/NT, HP-UX, AIX, Solaris, IRIX, SCO, more	289
<b>Patriot Pro II 750VA</b>	Line-Interactive	6	95	4	7/21	Y	DOS, NetWare, OS/2, Windows 3.1/95/98/NT, HP-UX, AIX, Solaris, IRIX, SCO, more	389
<b>Patriot Pro II 1000VA</b>	Line-Interactive	6	95	4	7/41	Y	DOS, NetWare, OS/2, Windows 3.1/95/98/NT, HP-UX, AIX, Solaris, IRIX, SCO, more	529
<b>Fortress 750VA</b>	Line-Interactive	4-6	95	0	6/24	Y	DOS, NetWare, OS/2, Windows 3.1/95/98/NT, HP-UX, AIX, Solaris, IRIX, SCO, more	499
<b>Fortress 1050VA</b>	Line-Interactive	4-6	95	0	6/34	Y	DOS, NetWare, OS/2, Windows 3.1/95/98/NT, HP-UX, AIX, Solaris, IRIX, SCO, more	669
<b>Fortress 1425VA</b>	Line-Interactive	4-6	95	0	5/43	Y	DOS, NetWare, OS/2, Windows 3.1/95/98/NT, HP-UX, AIX, Solaris, IRIX, SCO, more	899
<b>Fortress 1800VA</b>	Line-Interactive	4-6	95	0	8.5/68	Y	DOS, NetWare, OS/2, Windows 3.1/95/98/NT, HP-UX, AIX, Solaris, IRIX, SCO, more	1,099
<b>Fortress 2250VA</b>	Line-Interactive	4-6	95	0	5/68	Y	DOS, NetWare, OS/2, Windows 3.1/95/98/NT, HP-UX, AIX, Solaris, IRIX, SCO, more	1,199
<b>Axxium Rackmount 1000VA</b>	On-Line (double conversion)	5-6	87	0	9/41	Y	DOS, NetWare, OS/2, Windows 3.1/95/98/NT, HP-UX, AIX, Solaris, IRIX, SCO, more	1,099
<b>Axxium Rackmount 1500VA</b>	On-Line (double conversion)	5-6	87	0	8/61	Y	DOS, NetWare, OS/2, Windows 3.1/95/98/NT, HP-UX, AIX, Solaris, IRIX, SCO, more	1,499
<b>Axxium Rackmount 2000VA</b>	On-Line (double conversion)	5-6	87	0	14/151 (with 1 external battery cabinet)	Y	DOS, NetWare, OS/2, Windows 3.1/95/98/NT, HP-UX, AIX, Solaris, IRIX, SCO, more	1,359
<b>Axxium Rackmount 3000VA</b>	On-Line (double conversion)	5-6	87	0	7/151 (with 1 external battery cabinet)	Y	DOS, NetWare, OS/2, Windows 3.1/95/98/NT, HP-UX, AIX, Solaris, IRIX, SCO, more	2,279
<b>Compaq Computer Corp., P.O. Box 692000, Houston, TX 77269, <a href="http://www.compaq.com">http://www.compaq.com</a>. Circle 202</b>								
<b>T700 Tower 700VA</b>	Line-Interactive	4	96	5	5/19	Y	Windows NT, UnixWare, SCO, NetWare, intraNetWare OS/2, Warp	381
<b>T1000 Tower 1000VA</b>	Line-Interactive	6	96	5	8/49	Y	Windows NT, UnixWare, SCO, NetWare, intraNetWare, OS/2, Warp	510



# Networkable UPS Devices

Company address model	Product category	Output connections	Efficiency in normal mode (%)	Typical transfer time (msec)	Battery runtime @ maximum load/ Battery runtime @ 300VA (in minutes)	Hot-swappable batteries utilized	Platforms supported	Price (\$)
T1500 Tower 1440VA	Line-Interactive	6	96	5	9/79	Y	Windows NT, UnixWare, SCO, NetWare, intraNetWare, OS/2, Warp	668
T2000 Tower 1920VA	Line-Interactive	8	96	5	7/92	Y	Windows NT, UnixWare, SCO, NetWare, intraNetWare, OS/2, Warp	950
R1500 Rackmount 1440VA	Line-Interactive	6	96	5	7/67	Y	Windows NT, UnixWare, SCO, NetWare, intraNetWare, OS/2, Warp	1,045
R3000 Rackmount 2880VA	Line-Interactive	10	96	5	11/187	Y	Windows NT, UnixWare, SCO, NetWare, intraNetWare, OS/2, Warp	1,813
<b>Falcon Electric, P.O. Box 859, Monrovia, CA 91017, <a href="http://www.falconelectric.com">http://www.falconelectric.com</a>. Circle 203</b>								
SG 600-IT 600VA	On-Line (double conversion)	4	90	0	13/36	N	Windows 95/98/NT	790
SG 800-IT 800VA	On-Line (double conversion)	4	90	0	9/25	N	Windows 95/98/NT	890
SG 1K-IT 1000VA	On-Line (double conversion)	4	90	0	6/19	N	Windows 95/98/NT	990
SG 1.5K-IT 1500VA	On-Line (double conversion)	6	88	0	11/30	N	Windows 95/98/NT	1,590
SG 2K-IT 2000VA	On-Line (double conversion)	6	88	0	7/20	N	Windows 95/98/NT	1,990
SG 2.5K-IT 2500VA	On-Line (double conversion)	6	88	0	6/17	N	Windows 95/98/NT	2,590
SG 3K-IT 3000VA	On-Line (double conversion)	6	88	0	5.5/15	N	Windows 95/98/NT	2,890
SG 5K-ITX 5000VA	On-Line (double conversion)	Hard-wired	80	0	9/28	N	Windows 95/98/NT	5,390
SG 6K-ITX 6000VA	On-Line (double conversion)	Hard-wired	80	0	7/18	N	Windows 95/98/NT	5,890
<b>Fenton Technologies, 1910 E. Warner Ave., Unit C, Santa Ana, CA 92705, <a href="http://www.fentonups.com">http://www.fentonups.com</a>. Circle 204</b>								
PowerPal 1400VA Rackmount	Line-Interactive	6	N/A	2-4	7/45	Y	Windows 95/98/NT, NetWare	899
<b>Liebert Corp., 1050 Dearborn Drive, Columbus, OH 43229, <a href="http://www.liebert.com">http://www.liebert.com</a>. Circle 205</b>								
PowerSure ProActive 350VA *	Off-Line (standby)	4	96	4-6	5/7	N	Windows 95/98/NT, NetWare, Solaris, HP-UX, AIX, SCO OpenServer, OS/2	217
PowerSure ProActive 470VA *	Off-Line (standby)	4	96	4-6	5/-	N	Windows 95/98/NT, NetWare, Solaris, HP-UX, AIX, SCO OpenServer, OS/2	357
PowerSure ProActive 700VA *	Off-Line (standby)	4	96	4-6	5/-	N	Windows 95/98/NT, NetWare, Solaris, HP-UX, AIX, SCO OpenServer, OS/2	456
<b>MGE UPS Systems Inc., 1660 Scenic Ave., Costa Mesa, CA 92626, <a href="http://www.mgeups.com">http://www.mgeups.com</a>. Circle 206</b>								
Pulsar ESV 5+ 480VA	Line-Interactive	2	98	4	4/10	N	Windows 3.1/95/98/NT, OS/2, Mac OS, Linux, HP-UX, AIX, Solaris, Digital UNIX, SCO, Unisys SVR4, IRIX, VAX VMS	249
Pulsar ESV 8+ 780VA (tower or 3-unit rack)	Line-Interactive	4	98	4	5/25	Y	Windows 3.1/95/98/NT, OS/2, Mac OS, Linux, HP-UX, AIX, Solaris, Digital UNIX, SCO, Unisys SVR4, IRIX, VAX VMS	399 (tower), 589 (rack)
Pulsar ESV 11+ 1080VA (tower or 3-unit rack)	Line-Interactive	6	98	4	5/40	Y	Windows 3.1/95/98/NT, OS/2, Mac OS, Linux, HP-UX, AIX, Solaris, Digital UNIX, SCO, Unisys SVR4, IRIX, VAX VMS	579 (tower), 749 (rack)
Pulsar ESV 14+ 1400VA (tower or 3-unit rack)	Line-Interactive	6	98	4	5/80	Y	Windows 3.1/95/98/NT, OS/2, Mac OS, Linux, HP-UX, AIX, Solaris, Digital UNIX, SCO, Unisys SVR4, IRIX, VAX VMS	689 (tower), 969 (rack)

\* Product not bundled with software. Users must download free SiteNet MultiLink software from Liebert's Web site.



# Networkable UPS Devices

Company address model	Product category	Output connections	Efficiency in normal mode (%)	Typical transfer time (msec)	Battery runtime @ maximum load/ Battery runtime @ 300VA (in minutes)	Hot-swappable batteries utilized	Platforms supported	Price (\$)
<b>Pulsar ESV 22+</b> 2200VA (tower or 4-unit rack)	Line-Interactive	6	98	4	5/120	Y	Windows 3.1/95/98/NT, OS/2, Mac OS, Linux, HP-UX, AIX, Solaris, Digital UNIX, SCO, Unisys SVR4, IRIX, VAX VMS	1,148 (tower), 1,659 (rack)
<b>Pulsar EX 7</b> 700VA (tower or 2-unit rack)	On-Line (double conversion)	3	83	0	8/28	N	Windows 3.1/95/98/NT, OS/2, Mac OS, Linux, HP-UX, AIX, Solaris, Digital UNIX, SCO, Unisys SVR4, IRIX, VAX VMS	965 (tower), 1,209 (rack)
<b>Pulsar EX 10</b> 1000VA (tower or 2-unit rack)	On-Line (double conversion)	3	83	0	9/50	N	Windows 3.1/95/98/NT, OS/2, Mac OS, Linux, HP-UX, AIX, Solaris, Digital UNIX, SCO, Unisys SVR4, IRIX, VAX VMS	965 (tower), 1,209 (rack)
<b>Pulsar EX 15</b> 1500VA (tower or 2-unit rack)	On-Line (double conversion)	3	83	0	5/55	N	Windows 3.1/95/98/NT, OS/2, Mac OS, Linux, HP-UX, AIX, Solaris, Digital UNIX, SCO, Unisys SVR4, IRIX, IRIX, VAX VMS	1,315 (tower), 1,513 (rack)
<b>Pulsar EX 20</b> 2000VA (tower or 3-unit rack)	On-Line (double conversion)	4	83	0	9/90	N	Windows 3.1/95/98/NT, OS/2, Mac OS, Linux, HP-UX, AIX, Solaris, Digital UNIX, SCO, Unisys SVR4, IRIX, VAX VMS	1,545 (tower), 2,018 (rack)
<b>Pulsar EX 30</b> 3000VA (tower or 3-unit rack)	On-Line (double conversion)	4	83	0	6/100	N	Windows 3.1/95/98/NT, OS/2, Mac OS, Linux, HP-UX, AIX, Solaris, Digital UNIX, SCO, Unisys SVR4, IRIX, VAX VMS	2,455 (tower), 2,825 (rack)
<b>Minuteman UPS, 1455 LeMay Drive, Carrollton, TX 75007, <a href="http://www.minuteman-ups.com">http://www.minuteman-ups.com</a>. Circle 207</b>								
<b>Pro 700r</b> 700VA (rack-mount)	Line-Interactive	2	N/A	4	7/25	Y	Windows 3.1/95/98/NT, OS/2, NetWare, HP-UX, AIX, Interactive UNIX, SCO, SunOS, Solaris, UnixWare, Unisys SVR4	594
<b>Pro 1000r</b> 1000VA (rack-mount)	Line-Interactive	2	N/A	4	7/50	Y	Windows 3.1/95/98/NT, OS/2, NetWare, HP-UX, AIX, Interactive UNIX, SCO, SunOS, Solaris, UnixWare, Unisys SVR4	744
<b>Pro 1400r</b> 1400VA (rack-mount)	Line-Interactive	2	N/A	4	3/50	Y	Windows 3.1/95/98/NT, OS/2, NetWare, HP-UX, AIX, Interactive UNIX, SCO, SunOS, Solaris, UnixWare, Unisys SVR4	944
<b>Pro 2200r</b> 2200VA (rack-mount)	Line-Interactive	2	N/A	4	5/92	Y	Windows 3.1/95/98/NT, OS/2, NetWare, HP-UX, AIX, Interactive UNIX, SCO, SunOS, Solaris, UnixWare, Unisys SVR4	1,544
<b>Powerware Corp., (formerly Exide Electronics) 8609 Six Forks Road, Raleigh, NC 27615, <a href="http://www.powerware.com">http://www.powerware.com</a>. Circle 208</b>								
<b>Powerware 3115</b> 300-650VA	Off-Line (standby)	2-4	96	4	6-9/10-18	Y	Windows 3.x/95/98/NT, OS/2, NetWare, DOS, Mac OS, UNIX	130+
<b>Powerware 5105</b> 450-1500VA (tower or rack)	Line-Interactive	4-6	96	2-4	5-8/11-75	Y	Windows 3.x/95/98/NT, OS/2, NetWare, DOS, Mac OS, Linux, AT&T UNIX, Digital UNIX, Interactive UNIX, SCO, Solaris, SunOS, AIX, UnixWare	329+
<b>Powerware 5119</b> 1000-3000VA (tower or rack)	Line-Interactive	6-10	96	2-4	7-13/29+	Y	Windows 3.x/95/98/NT, OS/2, NetWare, DOS, Mac OS, Linux, AT&T UNIX, Digital UNIX, Interactive UNIX, SCO, Solaris, SunOS, AIX, UnixWare	699+
<b>Powerware 9 Prestige</b> 600-6000VA (tower or rack)	On-Line (double conversion)	4-10	96	0	6-15/25+	Y	More than 30 platforms, including Linux, OS/2, Windows 95/98/NT, NetWare	699+
<b>Powerware 9150</b> 8000-12500VA	On-Line (double conversion)	Up to 20	96	0	7-10/unlimited	Y	More than 30 platforms, including Linux, OS/2, Windows 95/98/NT, NetWare	8,396+
<b>Toshiba International Corp., 13131 W. Little York Road, Houston, TX 77041, <a href="http://www.tic.toshiba.com">http://www.tic.toshiba.com</a>. Circle 209</b>								
<b>1500 Series Rackmount</b> 1200VA*	On-Line (double conversion)	5	87	0	10/60	Y	Windows 95/NT, NetWare, HP-UX, AIX, SunOS, Solaris, SCO, XENIX, Unisys SVR4	1,899
<b>1400 Series Rackmount</b> 1500VA*	On-Line (double conversion)	4	87	0	10/120	N	Windows 95/NT, NetWare, HP-UX, AIX, SunOS, Solaris, SCO, XENIX, Unisys SVR4	2,699
<b>Tripp Lite, 1111 W. 35th St., Chicago, IL 60609, <a href="http://www.tripplite.com">http://www.tripplite.com</a>. Circle 210</b>								
<b>Omni Smart Series</b> 300-1400VA	Line-Interactive	4-6	96	2-4	5-10/5-120	N	Solaris, SunOS, Solaris Intel, HP-UX, IRIX, AIX, Digital UNIX, SCO, OS/2, Red Hat Linux, Slackware Linux, Windows 3.x/95/98/NT, Mac OS, more	165-649

\* Software available at an additional charge.



# APC's comprehensive enterprise-wide power protection maximizes uptime



## Symmetra™ Power Array™

The solution to growing datacenters

- Maximum uptime is guaranteed by unique single-phase Power Array™ power sharing technology
- Scalability allows modular expansion and reconfiguration as your datacenter grows
- Simplified maintenance dramatically lowers cost of ownership
- Highest availability/lowest operating costs in the marketplace
- N+1 redundancy design assures continuous availability
- Serviceable while load is up and running

## Silcon® DP300E Family

The solution for site-wide power protection



- 3-phase growth path from 10 kVA to 4 MW safeguards your investment
- Innovative Delta Conversion On-line™ design means unmatched efficiency and low operating costs
- Smaller footprint and cabling reduce cost of ownership
- Saves up to 18% in energy loss over traditional legacy UPS design
- Reduction in harmonic current from 30% (legacy) to 3%
- Up to nine units can be run in load sharing/redundant mode

## APC Global Services

The solution for pro-active power protection

- Quality solutions tailored to meet your requirements
- Provides a road map for implementing a power protection strategy that works
- PowerAudit™: the comprehensive, power quality consulting program
- Proper installation, proactive maintenance and cost-saving analysis
- Cost-effective 24x7 services that focus entirely on power quality
- Attractively priced services bundles available
- Guaranteed satisfaction or your money back
- 5,000 employees and over 8,000 business partners worldwide to serve you

Establishing a relationship with APC can save you millions of dollars. It can also ease the pain of having to manage the uncertainty of power-related downtime. *Computerworld* readers choose APC for reliability 10-1 over any other brand. Find out what 8,000,000 customers and 8,000 resellers in over 120 countries have already discovered: APC's Legendary Reliability™ is unmatched in the industry. Contact APC today and let our integrated datacenter power management solutions work for you.

Find out why APC has won over 130 awards for reliability and visit [www.apcc.com](http://www.apcc.com) today.

**APC**  
Legendary Reliability™

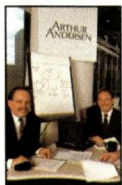

*"When the tax practice is without computers, \$35,000 per hour in revenue and production is lost. We need APC Symmetra™ to help us keep our platform stable."*

Bill Cope, Network Analyst,  
Arthur Andersen



*"The professionalism and thoroughness exhibited by the representatives of APC's Global Services Group in explaining all facets of the transition sold me on the APC Silcon® DP300E solution."*

Franco Pasquale, Simulator Team Leader,  
Boston Edison



*"With untested wiring in the new building and a network that needed to come online quickly, we felt the APC Global Service PowerAudit™ could help us identify and prevent any potential power problems."*

Scott Davidson, Manager of  
Development and Operations, Sarcom



**FREE** Enterprise Solutions Kit. Get **Legendary Reliability™** for your network.

To order: Visit <http://promo.apcc.com> Key Code k585z • Call 888-289-APCC x1241 • Fax 401-788-2797



# Networkable UPS Devices

Company address model	Product category	Output connections	Efficiency in normal mode (%)	Typical transfer time (msec)	Battery runtime @ maximum load/ Battery runtime @ 300VA (in minutes)	Hot-swappable batteries utilized	Platforms supported	Price (\$)
<b>SmartPro Net Series 450-3000VA</b>	Line-Interactive	6-8	85	2-4	5-10/15-240	Y	Solaris, SunOS, Solaris Intel, HP-UX, IRIX, AIX, Digital UNIX, SCO, OS/2, Red Hat Linux, Slackware Linux, Windows 3.x/95/98/NT, Mac OS, more	329-1,969
<b>Smart DataCenter 3000VA</b>	Line-Interactive	16	96	4-8	36/480+	Y	Solaris, SunOS, Solaris Intel, HP-UX, IRIX, AIX, Digital UNIX, SCO, OS/2, Red Hat Linux, Slackware Linux, Windows 3.x/95/98/NT, Mac OS, more	2,999
<b>Smart DataCenter 5000VA</b>	Line-Interactive	16	96	4-8	42/480+	Y	Solaris, SunOS, Solaris Intel, HP-UX, IRIX, AIX, Digital UNIX, SCO, OS/2, Red Hat Linux, Slackware Linux, Windows 3.x/95/98/NT, Mac OS, more	4,499
<b>Smart Unison 1000VA</b>	On-Line (double conversion)	6	87	0	10/160	Y	Solaris, SunOS, Solaris Intel, HP-UX, IRIX, AIX, Digital UNIX, SCO, OS/2, Red Hat Linux, Slackware Linux, Windows 3.x/95/98/NT, Mac OS, more	899
<b>Smart Unison 2200VA</b>	On-Line (double conversion)	6	87	0	7/160	Y	Solaris, SunOS, Solaris Intel, HP-UX, IRIX, AIX, Digital UNIX, SCO, OS/2, Red Hat Linux, Slackware Linux, Windows 3.x/95/98/NT, Mac OS, more	1,849
<b>Smart Unison 6000VA</b>	On-Line (double conversion)	Hard-wired	87	0	10/120	Y	Solaris, SunOS, Solaris Intel, HP-UX, IRIX, AIX, Digital UNIX, SCO, OS/2, Red Hat Linux, Slackware Linux, Windows 3.x/95/98/NT, Mac OS, more	5,499
<b>Smart Unison 10000VA</b>	On-Line (double conversion)	Hard-wired	87	0	10/240	Y	Solaris, SunOS, Solaris Intel, HP-UX, IRIX, AIX, Digital UNIX, SCO, OS/2, Red Hat Linux, Slackware Linux, Windows 3.x/95/98/NT, Mac OS, more	9,499

Maureen McKeon is a technology writer based in the Boston area. She can be reached via [mm@cpg.com](mailto:mm@cpg.com).

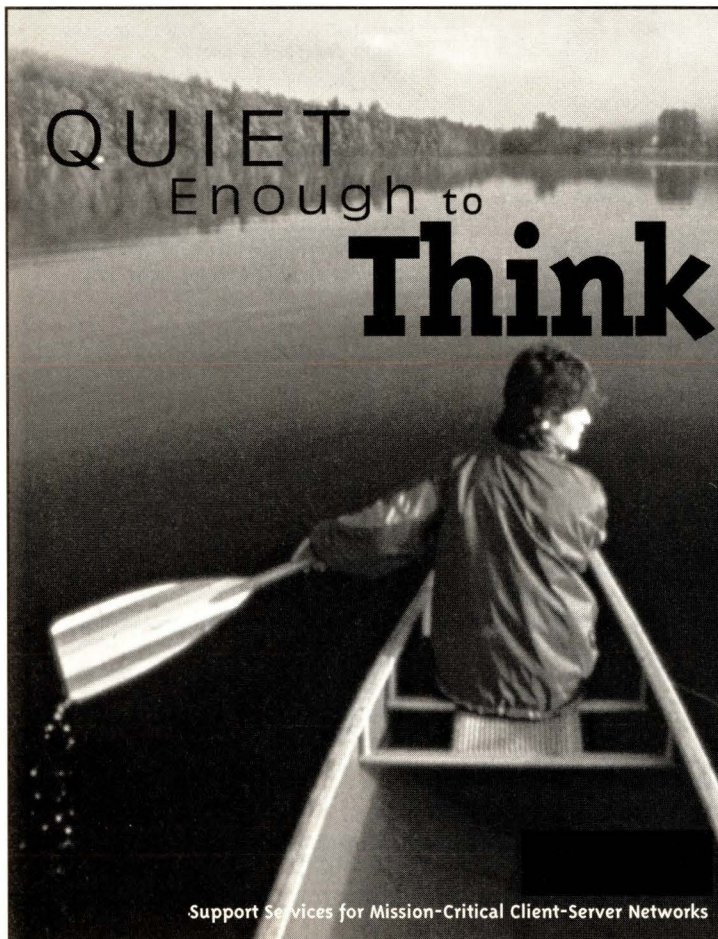

Support Services for Mission-Critical Client-Server Networks

## IT Support Services That Help You Focus on Your Mission

Does your company's success depend on your ability to plan carefully and stay ahead of the competition? Does the noise from issues that demand your immediate attention leave little time to think?

### We can help!

At Polaris, we specialize in providing support solutions to users of UNIX and Windows NT client-server networks. Our experts can help design, install, upgrade, migrate, administer, and increase the performance of your networks. We'll maintain the hardware and software, help your end users, manage your assets, and train your staff. In short, we can help make your networks more efficient, effective, and reliable, freeing you to concentrate on how to plan your IT resources to give your company a strategic advantage.

Since 1988 some of the world's most demanding customers have relied on us for support solutions that include:

- |                           |                                |
|---------------------------|--------------------------------|
| Technical Services        | Education                      |
| Help Desk Services        | Equipment Maintenance Services |
| Software Support Services | Computer Products              |

Discover how Polaris can help quiet the distractions so you can think strategically. Call us at 1-800-541-5831, or email us at [sales@polaris.com](mailto:sales@polaris.com), in the US. In Europe, contact us at +31-26-3116068 or email us at [sales@polaris.nl](mailto:sales@polaris.nl).



## FlashDisk: No Flash in the Pan

by MARK PETRIE

*Winchester Systems' FlashDisk could quite possibly be the 'world's fastest RAID array,' and its documentation isn't bad either.*

In the past few years, advances in processor and memory technology have brought about amazing advances in computational performance. But given the increasing demands of databases, high-fidelity audio, real-time video and high-resolution graphics in today's corporate environments, maintaining high levels of performance and reliability still present a daunting task to IT professionals. As a result, when shopping for a new RAID, increasingly IT managers are using performance as the benchmark for competing RAID solutions. Unfortunately, getting benchmark and performance data from most RAID manufacturers is an arduous task at best. One exception is Woburn, MA-based Winchester Systems Inc., which guarantees its FlashDisk is the world's fastest RAID disk array.

Winchester Systems has offered exceptional value and performance in disk and tape technology since 1981. As a result, it has developed an impressive clientele, which includes the likes of Boeing, Honeywell Inc., MCI WorldCom Inc. and Siemens AG. "People choose FlashDisk because of performance and dependability," says Joel Lieder,

chief executive officer of Winchester Systems. In fact, after talking with the company, it's readily apparent that performance is at the forefront of Winchester Systems' marketing strategy. This month, Computer Publishing Lab takes a look at FlashDisk Enterprise RAID, Winchester Systems' thoroughbred.

The Enterprise RAID system comprises a data center enclosure with 10 shelves. Each shelf holds a rack-mounted RAID array, with a maximum disk capacity of 109.2 GB (128 MB of cache). Therefore, a fully configured data center offers a capacity of 1,092 TB of storage and 1,280 MB of cache. Each array features hot-swappable disks, redundant power supplies, fans, AC power and a remote failure notification capability, which can page your administrator if a hardware problem is detected. For those requiring a truly fault-tolerant system, you will want to invest in the optional redundant controller. This type of redundancy may cost a few dollars more, but peace of mind is a valuable commodity when it comes to mission-critical data and applications.

The controller uses an Ultra Wide SCSI-to-Ultra Wide SCSI interface and

is available with five or six channels per controller, which can be configured as either a host or drive interface. The cache uses intelligent multithreaded write-back and write-through caching algorithms with dynamic look-ahead to optimize system performance. FlashDisk supports RAID levels 1 (mirror-



*A fully loaded FlashDisk Enterprise RAID system offers a capacity of 1,092 TB of storage and 1,280 MB of cache.*



**Table 1. FlashDisk Benchmark Results**

Test	Threads	Block size (KB)	File size (KB)	Throughput (KB/s)	N	Standard deviation
Random read	1	1	131,072	533.0	30	131.5
	1	64	1,048,576	11,624.7	25	175.9
	12	1	131,072	281.3	30	0.5
	12	64	1,048,576	11,617.6	25	155.8
Random write	1	1	131,072	206.3	20	1.1
	1	64	1,048,576	4622.1	20	16.2
	12	1	131,072	207.3	20	1.4
	12	64	1,048,576	4,620.0	20	24.7
Sequential read	1	1	131,072	2,100.8	30	45.1
	1	64	1,048,576	20,477.2	30	344.6
	12	1	131,072	2,036.0	30	35.7
	12	64	1,048,576	20,651.5	30	377.1
Sequential write	1	1	131,072	2,312.7	20	231.4
	1	64	1,048,576	12,450.5	20	106.3
	12	1	131,072	2,308.8	20	32.8
	12	64	1,048,576	12,431.0	20	107.8

All benchmark results reported in this article were gathered using the vxbench program, which is freely available from Veritas Software (<http://www.veritas.com>). The program enables the tester to create random and sequential I/O environments on VxFS, UFS and raw I/O file systems and partitions.—mp

ing), 3 (striping with dedicated parity), 5 (striping with interspersed parity) and 1+0 (mirroring with striping), as well as just a bunch of disks (JBOD).

On all but JBOD, you are able to use the "hot spare" feature. Hot spare is a dedicated replacement disk. In the event of a disk failure, FlashDisk automatically begins rebuilding the failed disk information on the hot spare. When the rebuild is complete, the disk group functions normally, only now it uses the spare disk rather than the defective one. What's more, this takes place behind the scenes and is transparent to the end user.

Rather than send us the entire cabinet, Winchester Systems sent us a single preconfigured rack-mountable RAID subsystem. It included 12 IBM Corp. 9-GB low-profile drives and 64 MB of cache. The 19-inch rack-mount case appeared well-constructed and was equipped with two handles for easy removal from the data center. The FlashDisk front panel contains an LED configuration menu, which is nicely documented in the installation manual. In addition, it has several useful alarms that will immediately alert you if there is a problem with the

power supply, operating temperature, fans or disks. Alongside the controller are 12 disk bays. Each bay is clearly labeled with the appropriate SCSI ID, which makes installing the drives and disk trays a snap.

The rear panel of the enclosure has dual fans and a 300W power supply. Both are hot-swappable and have convenient thumb-screw fasteners, which make removal and installation fast and easy. The SCSI interface is located under the fan modules. FlashDisk offers either 50-pin SCSI 2 or 68-pin SCSI 3 interfaces. Our system was equipped with two pairs of SCSI 2 interfaces. In addition, Winchester provides all the necessary SCSI cables, terminators, power cables and keys to lock/unlock the drive bays.

## Installation

The documentation that accompanies FlashDisk is excellent. The white and red, three-ring owner's manual takes you through the installation process step-by-step, using a combination of labeled photographs and numbered lists. It's easy to follow and provides additional information regarding the technical specifications of the

disk, controllers and disk enclosures.

Installation is completed in three steps:

- Connect the subsystem to either an SBus or PCI Ultra Wide SCSI adapter on the host machine.
- Reboot the host system and rebuild the device table.
- Configure the disk partitions/file systems as you would if you were adding another hard drive.

Configuration is performed via a serial port or through the front-panel controls. Both methods are clearly documented in the installation manual. When a system is preconfigured at the factory (like the one we reviewed), Winchester Systems includes full documentation of the settings in the owner's manual, as well as screen captures from the configuration menus.

To install the system, simply slide the labeled disk trays into the corresponding bays and connect the appropriate SCSI cables, terminator and power cables. After powering up the RAID array, reboot the host server and reconfigure the device tables to include the FlashDisk device. You should now be able to view the disks and default partition tables using



## Product Review

the `format` command. If the partition information is to your liking, complete the installation by creating a file system on the appropriate partitions and mount them.

### Performance

We connected FlashDisk to an UltraSPARC 10 workstation from Sun Microsystems Inc. The UltraSPARC 10 was equipped with a 333-MHz processor, 2-MB cache, 128-MB RAM and Solaris 2.7. FlashDisk was configured for RAID 5, which is striping with distributed parity. RAID 5 is similar to RAID 3, except that the parity blocks are interspersed across the disks. This allows for better read performance and more fault tolerance, and is commonly used for file servers and database applications.

The `vxbench` program from Veritas Software was used to gather the benchmark statistics. The program allows users to create a variety of I/O environments on VxFS (Veritas file system), UFS and raw I/O partitions. It can perform single- or multithreaded random and sequential reads and writes with various block sizes. Multithreaded I/O operations on a single file are useful for simulating a database environment. We used 10-KB and 64-KB block sizes for both single- and multithreaded operation. The `vxbench` output includes operational variables, such as the number of threads and block size, along with the number of I/Os per second. In addition to reporting the mean throughput, we have included the number of samples (N) and the standard deviation in Table 1 to illustrate the significance and range of values.

The first tests comprised sequential and random sustained reads and writes with one thread. Sequential reads with a 1-KB block size and a 131,072-KB file size averaged 2,100.8 KB/s, and writes averaged 2,312.7 KB/s. Random reads achieved throughput of 533 KB/s, but exhibited a fairly high standard deviation (131.5). While, random writes had a mean of 206.3 KB/s, with only a 1.1 deviation.

When we increased the block size to 64 KB, sequential read performance was a blistering 20,477.2 KB/s, while writes clocked in at 12,450.5 KB/s. Random reads averaged 11,624.7 KB/s, and writes chugged along at 4,622.1 KB/s.

Next, we ran the same benchmarks, only now with 12 threads and a file size of 1,048,576 KB. Interestingly, throughput was similar to that of the single-threaded environment. The only exception was the multithreaded random read, which was 53% lower when compared to the single-threaded random read throughput.

### Summary

Our tests substantiate Winchester Systems' data and performance claims. We found FlashDisk to be robust and easily scalable. Users will be pleased with the forethought the company has put into the product's design. The system uses quality components and is well-designed. We especially liked the configuration menus and diagnostic tools on the controller's front panel. Winchester also put quite a bit of thought into the design and content of the owner's manual. In addition to an easy-to-follow configuration section, the manual contains a comprehensive RAID overview, along with

### FlashDisk Enterprise RAID

#### Company

Winchester Systems Inc.  
400 W. Cummings Park  
Woburn, MA 01801

#### Phone

(800) 325-3700

#### WWW

<http://www.winsys.com>

#### Best Feature

Performance, documentation

#### Worst Feature

Price

#### Price

Unit with 12 9.1-GB drives  
(109.2 GB) = \$31,955  
Unit with 12 18.2-GB drives  
(218.4 GB) = \$34,292  
Unit with 8 36.4-GB drives  
(291.2 GB) = \$50,691

Circle 138

ample technical documentation.

If you should need assistance with the product, the company provides first-rate service. It promptly responded to our phone calls and emails, and was eager to assist with our review. Overall, we were quite impressed with the excitement the company exhibited when discussing its product lines. After tinkering with this product, Winchester's enthusiasm appears to be well-founded. ➔

**Mark Petrie** is a network administrator specializing in SunOS and Solaris environments. He can be reached at [petriem@yahoo.com](mailto:petriem@yahoo.com).

# Server/Workstation EXPERT

NOW  
ONLINE!

<http://sw.expert.com>

Search back issues of *Server/Workstation Expert* for key product reviews, crucial technical articles and unsurpassed columns.



*Michael Jay Tucker is a freelance writer living in Boston. He has written about the computer industry for more than 15 years and can be reached at mtucker@world.std.com.*

# Content Management: Galloping Off in All Directions

*In this information-based economy, companies are being asked to pump increasingly complex information around increasingly sophisticated networks, so much so, it's becoming increasingly difficult to manage all that content.*



If anyone still has any illusions about just how difficult a task large-scale document and content management is in an age of multiple media, a glance at the Bureau of National Affairs Inc., Washington DC, would be a quick cure. "We're a private, employee-owned legal publisher," explains Judy Flynn, director of publishing systems applications development for BNA. The company was founded in 1929 and has been employee-owned for more than 50 years.

What it publishes is legal information for a constituency that ranges from lawyers to business professionals to the federal government. "They [the government] buy back a lot of their own information," Flynn says. BNA's products include everything from newsletters to "notifications" (like newsletters, but much larger, and sometimes much more frequent—"Our *Daily Report for Executives* will run to 100 pages," Flynn says) to multibinder reference loose-leaf products and tax portfolios.

And all of these are available in multiple forms. Depending on the individual publication, there will be print versions, Web versions, email versions, CD-ROM versions...and on and on. Keeping the material current, accessible, properly formatted and more or less filed in the right place is, needless to say, complex. BNA has had to put together what it calls the PS2000 System, a centralized document, content and information management system using tools such as the Xyvision Par-

lance Document Management (PDM) and Xyvision Parlane Publisher (XPP) products from Xyvision Enterprise Solutions Inc., Reading, MA, and the Adept SGML Editor from Arbortext Inc., Ann Arbor, MI.

BNA started putting together its system in 1990. Now, several years later, "we have 3,000 users producing 39 notifications services on our servers, six dailies and 18 newsletters," says Flynn. There are also 25 reference services, and "they all go out in multiple media." In terms of hardware, the company is using a Sun Microsystems Inc. Ultra 3000E server running an Informix Corp. database and several smaller SPARC-based servers, an assortment of Sun Ultras used as X servers and 200 PCs running Microsoft Corp. Windows NT and Hummingbird Communications Ltd. Exceed X software.

"It's pretty much an all-Sun environment," Flynn says. It hasn't, she says, exactly been a piece of cake. "There are a thousand land mines." BNA's project team has faced problems from complex software integration to the standardization of data content and output formats, to the simplification of convoluted workflows and resistance to change from BNA's authors. "Many of our writers are mostly lawyers. They're interested in writing, not in how to place SGML tags." The project succeeded, she says, partly because it had significant buy-in from the top and from all the departments involved. "It had to be a joint effort," Flynn says.

So, all in all, BNA's is a complex and demanding application involving the

Illustration by ERIN TERRY



coordinated efforts of technologists, programmers, marketers, production staff, managers, editors and even journalists. Could content management as a discipline and market possibly get more complex?

The answer seems to be "yes." For coming up fast on the horizon are spies and counterspies, suits and countersuits, and yes, even the odd employee who wants to do some real work.

### What Do You Mean Content Management?

First, some definitions are in order. What is meant by the term "content management"? That sort of depends on who you talk to, and when.

Traditionally, it has meant the art of controlling the display and format of information, usually as electronic media, in some reasonably structured form. There is normally some sort of centralized authority, and once documents have been developed, they're piped out to end users in some sort of read-only form. In other words, it's a lot like print publishing and its practitioners have typically been the documentation departments of larger businesses.

"We've been targeting authors, editors, documentation delivery groups," says Kevin Duffy, president and chief executive officer of Xyvision Enterprise Solutions. "And we've had two distinct user groups. First, we have those who produce documents in support of what they sell." For example, companies that might produce a jet plane for the military and have to provide an enormous amount of documentation to go along with it. And, in recent years, this is an area that has gotten even more complex. Documentation departments now have to somehow support everything from print to the Web to CD-ROM and, therefore, their tools—like Xyvision—must as well.

The second group, says Duffy, is "those people for whom the information is itself a product." That is, publishers like BNA. For them, he says, the problem is simply: "How do you move your product in a more timely and cost-effective way than your competitor."

The fact is this is beginning to change. While the market for large-scale documentation products still exists, it isn't particularly growing, and other parts of the world are putting in claims for content management-style technology. "The broader markets are moving away from very structured information management," says Duffy. "They're getting involved in departments other than documentation." In other words, there are only so many manuals you're going to produce. There's a finite limit to how many technical writers (or journalists) you need. So, the high document and content management products are finding their markets a little crowded.

But, while that aspect of the market may be topping out, there's a new one opening up. Another class of corporate users has discovered that it, too, wants content management tools. That is, the actual desktop workers, who before asked for little more than word processors and email, have decided too they want sophisticated content management. "We have had to expand to include other forms of knowledge management," says Duffy. Specifically, this has meant that Xyvision has begun to offer system integration services, and to resell the Livelihood workgroup collaboration product from Open Text Corp.,

# SHARKRACK.™ THE ULTIMATE CONDO FOR SUN SERVERS AND COMPONENTS.



E3500



E4500



UniMount



### THE COOLEST RACKING SOLUTIONS FOR SUN!

The SharkRack has been designed to retain the look of Sun's exterior design for show-case data center installations and mission-critical data departments.

- **It's solid.** Built totally of heavy gauge steel, it's the only racking solution tested and certified by Sun's labs.
- **It's cool.** If your systems overheat - you're toast! SharkRack incorporates component level cooling.
- **It's approved.** SharkRack has the full sanction of Sun Microsystems which means it's fully supported by SunService™ and does not void your warranty because there are no modifications to your equipment.



Available from:

**AVCOM**  
www.avcom.com

Find out about our wide range of racking solutions for Sun and why more system managers are choosing SharkRack, call 408-749-9000 or visit our website: [www.sharkrack.com](http://www.sharkrack.com)

©1999 SharkRack, Inc. Specifications subject to change without notice. Sun is a registered trademark of Sun Microsystems, Inc.



VALUE ADDED RESELLER



Ontario Canada. Livelihood allows Xyvision's users to produce, modify and broadcast sophisticated documents at the desktop. It's as though every individual is a documentation department.

Xyvision's customers are now creating what are called "smart documents." That is, they can check themselves against databases of corporate policies, understand their own importance and forward themselves to the proper individuals. And they, too, are collaborative. That is, they are meant to produce documents that are created and modified by groups of closely cooperating individuals, who must be able to share not only basic premises but also subsequent revisions in a timely and cost-effective manner.

None of this is new, of course. Lotus Development Corp. Notes, various high-end authoring systems from companies such as Interleaf Inc. and document management companies like Adobe Systems Inc. introduced the concepts of collaborative and active documents years ago. The difference is in the degree. These content managers are meant to manage and produce not only intelligent memos or the odd electronic user manual. Rather, they manage whole interactive libraries—creating the documents, managing them within organizations that literally span the world, resolving cross-references among numberless documents, keeping them updated and, finally, maintaining them in a dozen different media, ranging from Web pages to printed brochures.

"It isn't for the fainthearted," Duffy says.

### Rated XML

The good news is if the market is a bit swampy, there is a bit of solidification going on at the technical level. Indeed, we may be in the midst of a revolution.

To date, two major coding schemes have dominated content management. The first was Standard Generalized Markup Language, or SGML. This, of course, is a well-defined (by the International Organization for Standardization, or ISO) means of maintaining large amounts of structured information. It has been used successfully for more than 10 years by organizations ranging from vast corporations to tiny nonprofits. The kicker? It doesn't like the Web. It works fine on CD-ROM and so forth, but it is so complex and so complete that it tends to overwhelm the average Web application.

So that leads us to the second major standard—Hypertext Markup Language, or HTML. That, too, is well-understood and has been implemented broadly. Every teenager with a Web page has some HTML under his or her belt. And, of course, therein lies the problem. It's too simple, too tied to the browser, too subject to technical obsolescence and, perhaps worst of all, increasingly burdened with vendor-specific extensions.

What was needed was something that was as Web-friendly as HTML and as powerful and as standardized as SGML. The result: eXtensible Markup Language, or XML, which can be (perhaps overly simplistically) considered a subset of SGML, a sort of SGML pared down for the Web, as developed and envisioned by the World Wide Web Consortium (W3C).

But, says Dennis Eskow, editorial director of the Instat Group, a market research firm based in Boston, MA, as far as content management is concerned, XML's power is in its abil-

ity to handle many different document formats. "It is a means to resolve the issue of how to make intellectual property easily transferable from one medium to another," Eskow says.

Most companies and organizations already have enormous amounts of documentation on hand, he says. The trick is often getting it out of a proprietary or obsolete format and into something multiple and dissimilar applications can use. "It [XML] will be ubiquitous," Eskow says.

For that reason alone, the past two years have seen a boom in the XML tool market. Xyvision is one such vendor, with its Parlance product suite. Others include Chrystal Software Inc., with its Astoria and Canterbury tools, Data Harmony Inc., with the Data Harmony software suite, Documentum Inc., with its Enterprise Document Management System 98 (EDMS 98), Object Design Inc., with eXcelon, Poet Software Corp., with Poet Content Management Suite (CMS), Auto-Graphics Inc., with Impact/Online, and Texcel Research Inc., with the Texcel Information Manager.

### A Dangerous Age

But if these organizational and technical problems of content management are daunting, they're a piece of cake compared with some of the legal ones.

"At one of our clients," says Kelly Haggerty, product marketing manager for Elron Software Inc., Internet Products Division, Cambridge, MA, "a young executive sent a...well, a very revealing photo of herself as an attachment in an email to her husband." You can probably guess the rest of the story. The email was sent to a distribution list rather than a single name, and dozens of corporate officers discovered they had a very personal snapshot in their mail queues.

That story is funny—at least, for everyone but the executive and her husband—where it stops being funny is when it turns into a disaster. For example, if an email message or Web page is associated with your server, that means your company is considered liable for what's in it. "The courts are ruling that, yes, if you emailed something offensive, then it is as if it went out on your letterhead," says Victor Woodward, vice president of technologies at Content Technologies Inc., Kirkland, WA, maker of the MimeSweeper content management tool.

Consequently, companies have found themselves on the wrong end of class action suits as a result of their employees' "private" email. Woodward recalls the case of a large oil company that was taken to court by some female employees who discovered their male counterparts were exchanging jokes, which they believed to be offensive, via email.

Ah, but it gets worse. What happens if you have an employee who is using your Internet connection to post racially charged messages to Usenet newsgroups after-hours? Or soliciting the sexual services of a minor? Or flaming your customers? Or downloading pornographic images and viewing them while customers are walking past? Or if someone inadvertently (or deliberately) downloads the personal files of your staff or customers onto your company Web page?

In all those cases, your company could end up in court. Indeed, it is almost certain to. But we're not finished yet. If class action suits don't scare you, how about industrial espio-



nage? The reality of the Internet is that anything can be anywhere at a moment's notice—including your trade secrets emailed to YourCompetition.com by a disgruntled employee.

## Content Control

All of this has led to a demand for a new kind of content management product—a content controller. This type of product is “predicated on the idea that you can look at the bits coming off a wire and then do something intelligent with them,” says Jim Hurley, managing director of information security at consulting firm The Aberdeen Group, Boston, MA. “[In terms of content control] the focus is on filtering—email, FTP, Web pages,” Hurley says, and preventing anything from viruses to sensitive information from moving along with other forms of content.

Vendors in this market include Content Technologies, with its MimeSweeper product (one of the oldest available content controllers), Worldtalk Corp., Santa Clara, CA, also known for its secure email products, and Elron Software, an Israeli firm that recently purchased control technology from Cambridge, MA-based On Software and entered the market with Message Inspector.

All of these basically sit at the perimeter (or, in some cases, on the desktop) of a corporate network and, in some fashion, check each and every file that comes in or goes out for sensitive material. This can be quite a trick. “Some products just look for keywords,” warns Elron's Haggerty. And that means some perfectly innocent communications can be rejected, while other really deadly ones zip right on through. “Take the case of ‘White Trash,’” Haggerty says. “That's an offensive term. But if the content manager is just looking for keywords, you could send a message reading, ‘Put the white paper in the yellow trash can,’ and it would be rejected.”

To overcome this, Haggerty says, Elron's product attempts to put keywords into the context of the rest of the sentence. In fact, Elron is partnering with the *Oxford English Dictionary* to build up an enormous list of words that might be considered offensive and in what contexts.

Another problem content controllers face is images, whether in Web pages or as binary attachments. If an attachment comes in at the end of a piece of email as a JPEG file, how can you tell if it's a close-up of your new product or a scanned centerfold? The answer, frankly, is you usually can't. All the major content controllers will open binaries and determine what format they are, even check them for viruses, but actually judging their contents for suitability is beyond them. Which isn't to say vendors aren't working on this problem.

“It isn't a product, and may never be,” says Content Technologies' Woodward, “but we are working on software in the lab in which we run thousands of images past a module and try to teach it to be able to distinguish between a picture of your family on the beach and, say, a bunch of scantily clad young women.” Among other things, he says, the software looks at things like the angle of a person's eyes in a photo. Are they looking at the viewer, as though looking into a camera while someone says “cheese,” or do they seem to be looking off at an angle, as if laying in a bed when someone shoots cheesecake?

So what, then, is the state of the content management market? Particularly for webmasters and others who deal with large collections of electronic documents?

It is an industry in radical flux. It has gone from being a market of products that are little more than automated filing cabinets, and vendors who are glorified typesetters, to an industry in which documents are active participants in international commerce, and in which vendors must be able to answer their customers needs for everything from format to legal liability.

In other words, it's complex and it's going to get worse, and there's not a lot anyone can do about it. In an information-based economy, companies have to pump increasingly complex information around increasingly sophisticated networks in even more delicate political, social and legal situations.

“Three years ago, the focus [of the content management industry] was just on documents,” says Xyvision's Duffy. “In just the last few months, it has changed radically.” In fact, he says, “it is a whole different world.” →

### Companies Mentioned in this Article

**Arbortext Inc.**  
1000 Victors Way  
Ann Arbor, MI 48108  
<http://www.arbortext.com>  
**Circle 140**

**Auto-Graphics Inc.**  
3201 W. Temple Ave.  
Pomona, CA 91768  
<http://www.auto-graphics.com>  
**Circle 141**

**Chrystal Software Inc.**  
10875 Rancho Bernardo Road  
San Diego, CA 92127  
<http://www.chrystal.com>  
**Circle 142**

**Content Technologies Inc.**  
204-D Central Way  
Kirkland, WA 98033  
<http://www.us.mimesweeper.com>  
**Circle 143**

**Data Harmony Inc.**  
P.O. Box 8640  
Albuquerque, NM 87198  
<http://www.dataharmony.com>  
**Circle 144**

**Documentum Inc.**  
5671 Gibraltar Drive  
Pleasanton, CA 94588  
<http://www.documentum.com>  
**Circle 145**

**Elron Software Inc.**  
**Internet Products Division**  
1 Cambridge Center  
Cambridge, MA 02142  
<http://www.elronsoftware.com>  
**Circle 146**

**Object Design Inc.**  
25 Mall Road  
Burlington, MA 01803  
<http://www.objectdesign.com>  
**Circle 147**

**Open Text Corp.**  
185 Columbia St. W.  
Waterloo, Ontario  
Canada N2L 5Z5  
<http://www.opentext.com>  
**Circle 148**

**Poet Software Corp.**  
999 Baker Way  
Ste. 100  
San Mateo, CA 94404  
<http://www.poet.com>  
**Circle 149**

**Texcel Research Inc.**  
1 Broadway, Ste. 600  
Cambridge, MA 02142  
<http://www.texcel.no>  
**Circle 150**

**Worldtalk Corp.**  
5155 Old Ironsides Drive  
Santa Clara, CA 95054  
<http://www.worldtalk.com>  
**Circle 151**

**Xyvision Enterprise Solutions Inc.**  
30 New Crossing Road  
Reading, MA 01867  
<http://www.xyenterprise.com>  
**Circle 152**



# URL/New Products

## Content Certification Software Unveiled

Factpoint's Content Certification Suite is aimed at managers of busy Web sites. The software is said to have a number of features, including a content certification process based on digital signatures, designed to ensure incorrect information is not posted to a corporate site.

As part of the certification process, an authorized user, such as a webmaster or marketing manager, must first design an approval process, which files and graphics relating to a site need to traverse in order to become certified for posting, Factpoint says. The approval process typically includes reviewing/editing files under version control. File updates are automatically assigned a new version number, enabling the "rolling back" to a previous date or version if needed. Because updates can be submitted via a regular browser, outside parties—such as advertising agencies or suppliers—can easily submit content without requiring special software, the company says.

In addition, webmasters can set various parameters to ensure outdated content is not published, or that certain types of content are not accidentally combined. For example, a price list could be declared valid for publication only between certain dates, or an image file could be allowed to appear only on specific pages or in combination with specific files. The Content Certification Suite will then automatically publish content to staging servers and production servers when certain events—such as a release date—are triggered.

The final step of the certification process is the creation of a Content Certificate, consisting of a digital hash of the content, the content's URL and the user's X.509 digital certificate. To help prevent outside hackers from copying and spoofing a site, all certified pages carry the Factpoint logo. If the content is altered, the logo will indicate it is no longer certified.

Factpoint Content Certification Suite runs on Solaris, HP-UX, Linux and Windows NT. Web server support includes Microsoft Corp. Internet Infor-

*The product descriptions are compiled from data supplied by the vendors. To contact them for more detailed information, circle the appropriate reader service number on the card located elsewhere in this issue.*

mation Server 4.0+ and Netscape Communications Corp. Enterprise Server 3.51+. Pricing starts at \$100,000 for 100 users.

**Factpoint Inc.**  
10 Burlington Mall Road  
Burlington, MA 01803  
<http://www.factpoint.com>  
**Circle 154**

## Mainframe Data on the Web

Information Builders has begun offering Parlay Application Integration Server, a Java application server that extends mainframe data, applications and IBM Corp. MQSeries applications to corporate intra/extranets and the Internet.

Parlay is said to enable developers to create Java applications that integrate with enterprise-class systems, including IBM's Customer Information Control System (CICS), Information Management System/Transaction Management (IMS/TM) and MQSeries-based systems. It also provides integration services to other CORBA 2.0- and COM-

## Email Access via the Phone

Infinite Technologies has released two products designed to make receiving email easier for traveling professionals who don't have access to a laptop or their desktop computer.

Ivoice Pro is a client/server email system, Internet gateway and email voice attendant, which enables users to access email messages from any telephone. The system combines an IMAP4/POP3 email client/server SMTP gateway and voice system. Using Ivoice Pro, email users can also access their mailboxes via a standard Web browser. It supports a range of email systems, including Lotus Development Corp. Notes and cc:Mail, Microsoft Corp. Exchange and Outlook, and Qualcomm Inc. Eudora. Ivoice Pro costs \$549 for a 10-user license.

InterChange Wireless E-mail Gateway

4.0 offers users of cellular telephones that support the Wireless Application Protocol (WAP) secure access to corporate email and the ability to retrieve, reply, forward, delete and create email messages from anywhere. Infinite InterChange is a Windows-compatible

server application that integrates seamlessly with any IMAP4, POP3 or SMTP email system. Remote wireless users can connect securely through the InterChange server for direct access to corporate mailboxes, Infinite says.

InterChange Wireless E-mail Gateway 4.0 is priced starting at \$349 for 10 users.

**Infinite Technologies**  
11433 Cronridge Drive  
Owings Mills, MD 21117  
<http://www.ihub.com>  
**Circle 153**

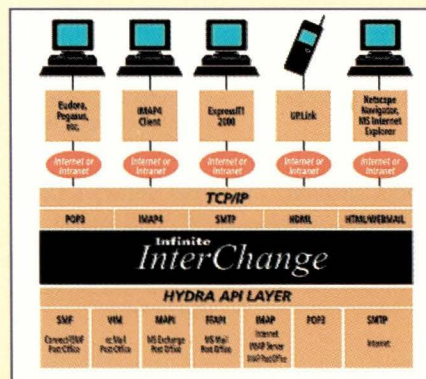



based distributed applications.

Parlay includes support for Java Naming and Directory Interface (JNDI), which enables Java components to be located at runtime by a global directory regardless of their location on the network; Java servlets, so developers can create Web-based applications that

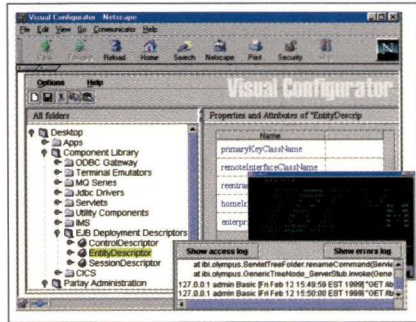

use HTML and Java servlets to communicate with Parlay's built-in HTTP server (or any external Web server co-resident with Parlay); the integration of C/C++ application code with Java components, so newly developed Java programs can call existing programs; and Secure Sockets Layer (SSL). Full support for Enterprise JavaBeans (EJB) 1.0 is planned for later this year.

Parlay Application Integration Server supports more than a dozen platforms, including AIX, Solaris, HP-UX, Linux, OS/390 and Windows NT. Pricing starts at \$11,250 per CPU. Parlay Server-Side Enterprise JavaBeans—which provide additional messaging services for MQSeries, IMS/TM, CICS and TN3270 emulation—can be purchased separately for \$2,250 per CPU.

#### Information Builders Inc.

2 Penn Plaza  
New York, NY 10121  
<http://www.ibi.com>

Circle 155

### Multipurpose Modem for Remote Users

EZ Rider Pro from Arescom offers telecommuters and remote workers the choice of using either a 56-Kb/s analog connection, asymmetric digital subscriber line (ADSL) or cable connection to access the Internet. It also supports 10/100BaseT Ethernet connections and enables a small office network to share a single IP address from a standard analog dial-up account via a built-in, dual-

speed hub, Arescom says.

The modem's Ethernet input interface allows EZ Rider Pro to function as an Ethernet-to-Ethernet router, enabling users to segment Ethernet local area networks (LANs). EZ Rider Pro can also act as a backup for the Ethernet interface, providing redundant interface and network backup capabilities, the company says.

EZ Rider Pro supports Dynamic Host Configuration Protocol (DHCP), Network Address Translation (NAT), IP Filtering Firewall and the Microsoft Corp. VPN client. It costs \$775.

#### Arescom Inc.

46724 Lakeview Blvd.  
Fremont, CA 94538  
<http://www.arescom.com>

Circle 156

### UltraSPARC Server for ISPs

EIS Computers has introduced Fusion-iX/2, a low-profile, rack-mount UltraSPARC server designed for Internet service providers (ISPs) that need to double the number of servers in their existing racks.

Built with Sun Microsystems Inc.'s SPARCengine Ultra AXi PCI board, Fusion-iX/2 features a 300-MHz UltraSPARC-IIi CPU (a 360-MHz model is also available), up to 1 GB of RAM, dual Ultra Wide SCSI channels and support for 100BaseT Ethernet. It can house up to four hard drives and two PCI cards and comes in a 3.5-inch rack-mount enclosure. In addition, it has a hot-swappable power supply and room for a floppy drive, tape drive or CD-ROM, EIS says.

Pricing for Fusion-iX/2 varies according to configuration. A 300-MHz CPU with 256 MB of RAM, 9-GB hard drive, CD-ROM and Solaris preinstalled costs \$4,199; the same configuration installed with Linux costs \$3,675.

To complement the new server, EIS is also offering two accessories that are said to enable ISPs to better design and manage their rack-mount environments. A 1U keyboard-video-mouse (KVM) tray combined with an 8- or 16-port console switch allows a whole rack of servers to be controlled by a single integrated console, the company says. The KVM tray costs \$2,259, and

the console switch costs \$949 for the 8-port version or \$1,575 for the 16-port version.

In addition, EIS offers the Master-Switch AC power manager, which reportedly allows remote users to cycle AC power (manually or automatically) to servers via a standard Web browser. It costs \$510.

#### EIS Computers Inc.

207 W. Los Angeles Ave., Ste. 303  
Moorpark, CA 93021  
<http://www.eis.com>

Circle 157

### XML for Handheld Devices

One of the leading vendors of eXtensible Markup Language (XML)-based data exchange products has brought its technology to the handheld computing market. Bluestone Software now offers Bluestone XML-Contact for the Palm Computing platform, an XML application for 3Com Corp.'s Palm Computing devices.

The product is designed to exchange data between handheld devices and corporate databases using XML. The Bluestone XML-Contact client runs directly on the Palm Computing device and allows users to select information to upload/download, then translates that information into XML-based documents. The Bluestone XML-Contact server runs on any XML server. It processes the XML document sent from the Palm Computing device, interacts with the target database and sends back the appropriate information as an XML document.

Bluestone XML-Contact can be downloaded for free from the company's Web site.

#### Bluestone Software Inc.

1000 Briggs Road  
Mount Laurel, NJ 08054  
<http://www.bluestone.com>

Circle 158

### New, Improved E-Commerce Tool

Open Market has released ShopSite 4, an application for building online stores. This latest release features an enhanced setup wizard, a new user interface and predesigned site templates.

In addition, Open Market has added



new database management capabilities for backing up and restoring data.

ShopSite also comes with a new shopping cart program, a configurable site search utility, a module for managing sales and enhanced editing features, Open Market says.

ShopSite 4 runs on a service provider's Web server; nothing is installed on the user's machine. A list of Open Market partners and resellers is available from the company's Web site; pricing starts at \$100 per month. For service providers interested in hosting ShopSite, the software runs on Solaris, Linux, IRIX and Windows NT, and is compatible with Web server software from Apache, Microsoft Corp. and Netscape Communications Corp.

**Open Market Inc.**

1 Wayside Road  
Burlington, MA 01803  
<http://www.openmarket.com>

**Circle 159**

## Keep Bandwidth Hogs in Check

Allot Policy Manager from Allot Communications enables IT managers to configure and manage limited bandwidth resources using scalable, dynamic network policies, the company says.

Allot Policy Manager retrieves data from directory services through the use of Lightweight Directory Access Protocol (LDAP). Network policies, driven by an organization's existing databases, are dynamically updated and loaded into the Policy Manager. This seamless integration allows an organization to maintain/update users, applications and policies independently, while Allot policy-enforcement devices automatically adjust to meet user demands on the network, the company says. Policy-based actions tailor network usage according to corporate goals or a network user's service-level agreement (SLA).

Internet service providers (ISPs) that cannot integrate information about multiple users with their existing systems, can now define a small number of service classes for providing tiered offerings, Allot says. This is accomplished by associating groups of users with a particular service or offering. Enterprise networks can allocate bandwidth based

on employees, departments or application attributes contained in a corporate directory. Meanwhile, electronic commerce applications can link customer databases and associate network policies with dynamically changing database information such as customer frequency status or money spent, Allot says.

Allot Policy Manager runs on Windows NT and costs \$9,995.

**Allot Communications Inc.**

292 E. Main St.  
Los Gatos, CA 95030  
<http://www.allot.com>

**Circle 160**

## Tool to Capture Electronic Signatures

ePad from Interlink Electronics is a pen input device that captures handwritten signatures for use in electronic commerce, online banking and signature-based security systems.

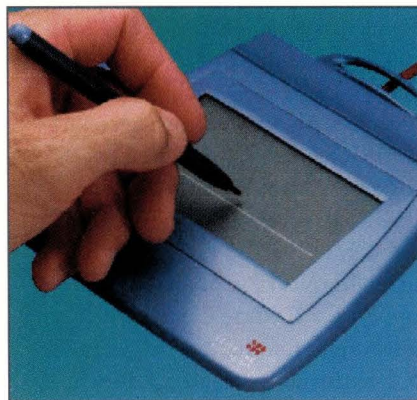

ePad reportedly uses a pressure-sensitive input surface that is designed to emulate the natural feel of signing on paper. When used with Interlink's pen input software, ePad captures signatures on-the-fly and inserts them into Microsoft Corp. Word documents. The device not only captures the signature, but also reports the line shape and stylus pressure needed to electronically bind and verify the signature, the company says.

ePad connects to a PC serial port and costs \$69.95.

**Interlink Electronics Inc.**

546 Flynn Road  
Camarillo, CA 93012  
<http://www.interlinkelec.com>

**Circle 161**

## Application Development, Deployment

Sybase has announced the availability of Enterprise Application Studio (EAStudio) 3.0, a set of application development and deployment tools that includes Enterprise Application Server (EAServer) 3.0, PowerJ 3.0 and PowerBuilder 7.0.

EAServer 3.0 is designed to deploy Web-based and distributed applications by incorporating the capabilities of a component transaction server and a dynamic Web page server, the company says. It offers cross-client and cross-component support for distributed applications based on CORBA, JavaBeans, Enterprise JavaBeans, COM and C/C++ applications.

PowerJ 3.0 enables users to build Internet applications that use HTML, Java clients and deliver Java server-side components. PowerBuilder 7.0 reportedly allows developers to build applications based on Web-based components and features a new HTML DataWindow, which allows users to deploy to all major Web browsers, Sybase says.

EAStudio 3.0 costs \$3,445 per developer. Prices for separate components are as follows: PowerBuilder 7.0 costs \$2,995 per developer, PowerJ 3.0 is priced at \$595 per developer and EAServer 3.0 costs \$2,995 per single license. All three components run on Windows 95/98/NT, and EAServer also runs on Solaris.

**Sybase Inc.**

6475 Christie Ave.  
Emeryville, CA 94608  
<http://www.sybase.com>

**Circle 162**

## Windows NT Firewall Upgrade

CyberGuard has upgraded its firewall software with the release of CyberGuard Firewall for Windows NT Release 4.2.

The new version features the company's Proxy Framework technology, which reportedly serves as the foundation for all proxies. Users have the option of integrating any new antivirus product into the CyberGuard Firewall, the company says.

CyberGuard Firewall supports Secure Sockets Layer (SSL), static Network



Address Translation (NAT) and split Domain Name System (DNS) capabilities, which hide internal addresses and system names from external access when the firewall is configured as the network DNS server. Pricing for CyberGuard Firewall for Windows NT Release 4.2 starts at \$1,495.

**CyberGuard Corp.**

2000 W. Commercial Blvd., Ste. 200  
Fort Lauderdale, FL 33309  
<http://www.cyberguard.com>

Circle 163

### Application Server with XML Support

InfoSpinner has unveiled ForeSite Application Server 3.0. This latest release features eXtensible Markup Language (XML) support; a packaged Java Integration Framework (JIF) with JavaBeans, which uses XML for enterprise data access; and encryption across clusters. InfoSpinner says it provides drag-and-drop application integration, complete support for enterprise storage procedures, host integration connection caching and pooling, and support for IBM Corp. MQSeries, Customer Information Control System (CICS) and Java servlets.

Pricing for the base ForeSite Application Server 3.0 starts at \$25,000, with add-on modules available. It runs on Solaris 2.5.1, AIX 4.2, HP-UX 10.10 and Windows NT 4.0.

**InfoSpinner Inc.**

1601 N. Glenville Drive, Ste. 108  
Richardson, TX 75081  
<http://www.infospinner.com>

Circle 164

### Service to Deliver Video

One of the barriers preventing companies from delivering multimedia content via the Internet is the high cost of digitizing and editing video. Javu Technologies may have the answer with the launch of VideoFarm.com, the company's new service designed to make the delivery of multimedia content via the Internet affordable.

VideoFarm.com, which is maintained by Javu, is said to host multimedia content, convert video to a digital format and provide editing software. This software can be accessed via any Web browser, which allows users to edit multimedia data directly online, Javu says. Pricing for the service starts at \$49 per month for 1 GB of storage on Javu servers.

**Javu Technologies Inc.**

Chelsea Piers, Pier 62  
New York, NY 10011  
<http://www.javu.com>

Circle 165

### Free Site Management Software

Mercury Interactive has released its Astra SiteManager 2.0 site management application.

With Astra SiteManager, users can schedule Web site scans, create customized HTML reports and run an off-line analysis of a site's performance in terms of download time, Mercury says. In addition, Astra SiteManager comes with a browser view function, which allows users to see what a site would look like if viewed with different browsers.

Astra SiteManager 2.0 runs on Windows 95/98/NT 4.0 and can be downloaded for free from Mercury's Web site.

**Mercury Interactive Corp.**

1325 Borregas Ave.  
Sunnyvale, CA 94089  
<http://www.merc-int.com>

Circle 166

### Network Management for Windows 2000

Telco Research's Tru Access Manager is said to provide IT managers with reports on the network usage of individual users and workgroups. It monitors usage for policy violations based on an integrated set of policy filters, Telco says. Violations can be logged and reported via email or SNMP.

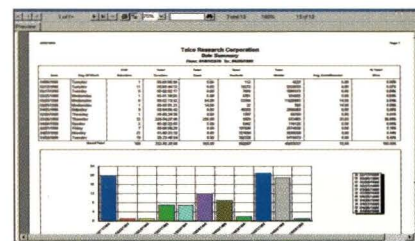

Tru Access Manager's scheduler can also schedule the generation of reports and perform routine maintenance at any interval, eliminating the need for constant intervention, Telco says. All reports can be generated as text, rich text or HTML. Tru Access Manager runs on Windows NT/2000 and is priced starting at \$3,995.

**Telco Research Corp.**

616 Marriott Drive  
Nashville, TN 37214  
<http://www.telcoresearch.com>

Circle 167

# Server/Workstation Expert Archive

Search back issues of Server/Workstation Expert for key product reviews, crucial technical articles and unsurpassed columns.

**NOW  
ONLINE!**

<http://sw.expert.com>



# NEW PRODUCTS

The product descriptions are compiled from data supplied by the vendors. To contact them for more detailed information, circle the appropriate reader service number on the card located elsewhere in this issue.

## Rack-Mount Ultra AXi for Telcos

The RackMount-2UAXi system, aimed at Internet service providers (ISPs), telecommunications companies and other firms with a need for small-footprint rack-mount servers, is a 19-inch steel enclosure with a 1.44-MB floppy drive, a 5.25-inch half-height slot for CD-ROM, tape or removable disk drive, and six fans. It can reportedly accommodate up to three internal 7,200- or 10,000-RPM disk drives or two half-height drives. It uses Sun Microsystems Inc.'s Ultra AXi mother-



board, which offers features such as upgradable UltraSPARC-III processor modules with processing speeds of up to 360-MHz, integrated dual-channel Ultra Wide SCSI, two 33-MHz/32-bit PCI slots and integrated 10/100-MB Ethernet. Pricing starts at \$3,855 for a 300-MHz CPU system.

### Rave Computer Association Inc.

36960 Metro Court  
Sterling Heights, MI 48312  
<http://www.rave.com>

Circle 101

## HP Server Offers Dual-Processor Path

Hewlett-Packard's HP 9000 N-Class Enterprise Server is a PA-RISC server. The N-Class features up to eight 64-bit PA-8500 processors and an IA-64 system bus designed to support future generations of both PA-RISC and IA-64 processors, HP says.

Cataloged between HP's high-end V-Class servers and K-Class midrange UNIX servers for workgroups, the N-Class is aimed at business-critical application needs such as enterprise resource planning (ERP), data warehousing and technical computing. It can be configured with either of HP's PA-8500 processors—360- or 440-MHz—and with 512 MB to 16 GB of RAM. It offers up to 18 GB of internal disk storage capacity, a maximum external storage capacity of 71 TB and includes a total of 12 I/O slots.

The N-Class server comes with the 64-bit HP-UX 11 operating system pre-installed (but does not support HP-UX 10.20) and features a complete set of built-in management tools, including HP's SecureWeb console for easy, browser-based administration and an extended fault-detection system that features a separate processor and bus to monitor

## New Enterprise Storage Solutions

The EnterpriseXpress storage system from Overland Data is available in two models: two-drive and four-drive. The two-drive system comes with two DLT7000 tape drives and 26 cartridge slots, supporting customer installations with 150 to 300 GB of disk capacity and a backup rate of 36 GB/hour. The four-drive system features four DLT7000 drives and 52 cartridge slots, targeting enterprise customers with 300 to 600 GB of data. It can be scaled to provide 3.5 TB of native capacity and a backup rate of 180 GB/hour. Each model can be expanded in increments as small as one drive and 10 cartridge slots. Expansion modules slide into the library cabinet and snap into place, and can be added or removed without impacting operation, Overland says. EnterpriseXpress costs \$38,290 for the dual-drive model and \$75,680 for the four-drive model.

Overland has also announced a new technology designed to enable remote operation and management of its automated tape libraries and autochangers from anywhere in the world via a standard Web browser. Web TLC (Total Library Control) is a platform-independent unit that connects to both the tape library and the Internet via an Ethernet connection. Because it does not use the host server connected to the tape library, it is compatible with a variety of platforms, the company says. This design allows an administrator to remotely configure, monitor and control the storage system via any browser. Web TLC is priced at \$1,995.

### Overland Data Inc.

8975 Balboa Ave.  
San Diego, CA 92123  
<http://www.overlanddata.com>

Circle 100

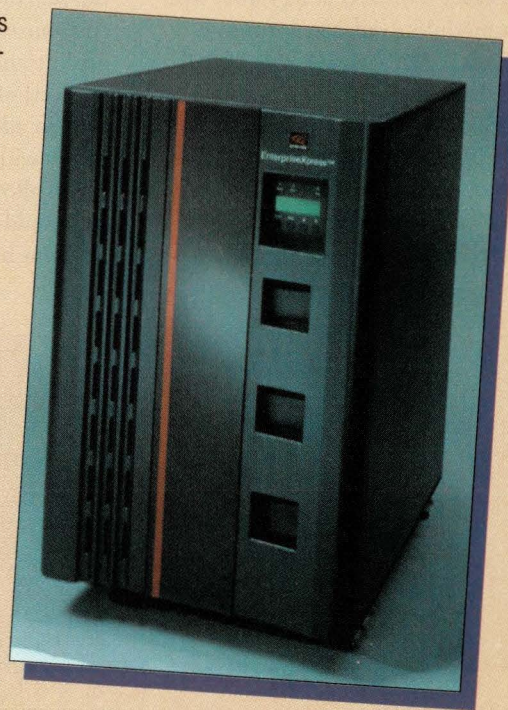



## New Products

the system, the company says. The server also features HP's WebQoS 2.0 technology for stabilizing, optimizing and prioritizing Internet users and applications. The HP 9000 N-Class Enterprise Server is priced starting at \$48,000.

**Hewlett-Packard Co.**  
3000 Hanover St.  
Palo Alto, CA 94303  
<http://www.hp.com>  
**Circle 102**

### Battery Power Protection for Networks

The PowerSure ProActive Series uninterruptible power supply (UPS) from Liebert reportedly provides power protection for workstations, peripherals and network equipment such as routers, bridges and hubs. Each model (350VA, 470VA and 700VA) offers five minutes of battery backup at full-load, protection for phone and data lines, lightning and surge protection for all outlets and is available in a wide range of voltages.

PowerSure ProActive also includes an intelligent power management function designed to withstand buck and boost transitions without transference to the battery, thus extending battery life and, at the same time, protecting load capacities, the company says. Full-sequence testing capabilities are said to allow IT managers to conduct comprehensive battery/system checks. Available in 115V and 230V versions, PowerSure ProActive is designed for use in most countries.

Each PowerSure ProActive system comes with a Multilink communications cable and users are required to download free SiteNet MultiLink software from the company's Web site. The software runs on Solaris, AIX, HP-UX, SCO,

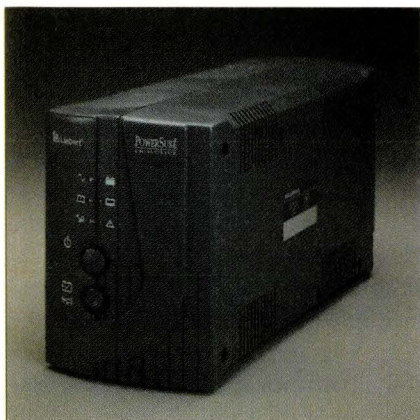

NetWare and Windows 95/98/NT. PowerSure ProActive costs \$217 for the 350VA model, \$357 for the 470VA model and \$456 for the 700VA model.

**Liebert Corp.**  
1050 Dearborn Drive  
P.O. Box 29186  
Columbus, OH 43229  
<http://www.liebert.com>  
**Circle 103**

### High-Performance Computing in a Package

The High Performance Computing System (HPC-1) from Sky Computers is aimed at environments requiring maximum raw computing power, such as real-time applications in technical settings. HPC-1 is packaged in single-chassis increments of either 6U or 9U form factors, each able to accommodate up to 16 boards, Sky says. Each 6U chassis provides 42 gigaflops (giga floating-point operations per second) of processing power, while each 9U chassis provides 170 gigaflops.



The computing power of the HPC-1 reportedly comes from off-the-shelf PowerPC microprocessors. The communications interconnect between boards, chassis and systems is provided by the ANSI standard SKYchannel 320-MB/s packet bus architecture. Multiple SKY-channel connections are said to facilitate fast communication throughout the system hierarchy to continually provide maximum system throughput.

## GOOD TOOLS ARE JUST THE BEGINNING...

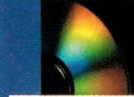
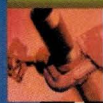

Sun recognizes that you need more than a good set of tools to develop your products. So we created **Sun Developer Essentials™ Subscriptions** to provide you with a comprehensive development solution:

- APIs
- Environments
- Technologies
- Software Previews
- Education
- Latest Information on Sun Innovations
- Software Updates
- Single Payment CD Subscription
- ...and Much More!



#### Foundation Edition \$195\*

The essential set of tools and technologies for developing products on the Java™ platform and Solaris Operating Environment™ software.

#### Professional Edition \$995\*

The Professional set of cross platform tools for developing products on the Java™ platform and Solaris™ Operating Environment software - plus all the features of the Foundation Edition package.

#### Enterprise Edition \$2,995\*

The complete set of advanced cross-platform tools for creating and deploying client-server and web-based applications in an enterprise environment - plus all the components of the Professional Edition package.

\*Prices and availability subject to change without notice and do not include shipping and handling.

Sun Developer Essentials Subscriptions  
Subscribe Today.

[www.sun.com/developers/essentials.html](http://www.sun.com/developers/essentials.html)

Refer to Offer Code DE006 when ordering



©1999 Sun Microsystems, Inc. All rights reserved. Sun, Sun Microsystems, the Sun logo, Sun Developer Connection, the Sun Developer Connection logo, Sun Developer Essentials, the Sun Developer Essentials logo, Solaris, Solaris Operating Environment, the Solaris logo, Java and the Java Coffee Cup logo are trademarks or registered trademarks of Sun Microsystems, Inc. in the United States and other countries.

subscribe



## New Products

Each HPC-1 system is custom-configured and can include features such as Fibre Channel I/O, RAID or High-Performance Parallel Interface (HIPPI). The system offers a capacity of 128 GB of memory and 680 gigaflops of performance for the VME 6U version and 512 GB of memory and 2,720 gigaflops for the VME 9U version. It runs on Solaris. Pricing for the HPC-1 starts at \$500,000.

**Sky Computers Inc.**  
27 Industrial Ave.  
Chelmsford, MA 01824  
<http://www.sky.com>  
**Circle 104**

### Super-Thin LCD from Panasonic

Panasonic Computer Peripherals has unveiled a new, super-thin monitor, the PanaFlat LC90S 19-inch digital multiscan LCD (liquid crystal display), equipped with built-in stereo speakers and USB connectors.

The PanaFlat's five USB connectors

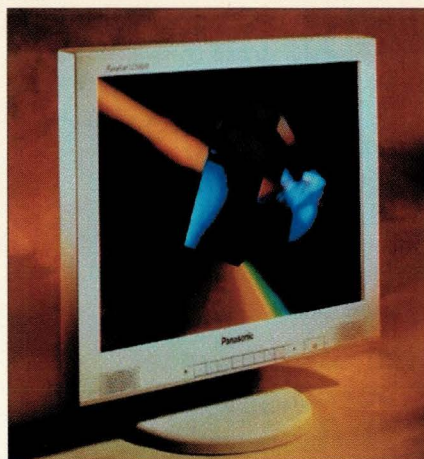

make it easy to attach peripherals to a PC by standardizing on one type of connection and allowing ports to be located on the monitor for easy accessibility, the company says. Created for peripherals that require high-speed data transfer, such as digital cameras and printers, USB connectors can transfer files at 12 Mb/s.

The LC90S also features a thin-film transistor (TFT) active-matrix screen, 0.294mm dot pitch, a spectrum of

16.77 million colors and a contrast ratio of 200:1.

The monitor can be used with Sun Microsystems Inc. UNIX workstations and desktops running Windows 95/98/NT. It is priced at \$2,000.

#### Panasonic Computer Peripherals Co.

2 Panasonic Way  
Secaucus, NJ 07094  
<http://www.panasonic.com>  
**Circle 105**

### Building, Managing User Interfaces

Aonix has released TeleUse 3.2.1 user interface management system (UIMS) software. The product reportedly allows developers to design and build object-oriented GUIs in C, C++ or HTML, and incorporates the latest version of the Motif X Window standard (2.1) and CDE 2.1 functionality. The Motif support includes new Motif 2.1 widgets, such as XmSpinBox, XmComboBox, XmContainer and XmNotebook, and provides comprehensive support for the composition and usage of XmRenderTable and XmRendition objects to express text-rendering attributes.

This latest version updates support for UNIX-to-Windows 95/98/NT cross development, which is said to enable developers to create interfaces for either UNIX or Windows platforms using common UNIX Motif-based sources. TeleUse 3.2.1 costs \$7,500 for a single seat and is available for Tru64 UNIX (formerly Digital UNIX), HP-UX, AIX, IRIX, Solaris and Linux.

#### Aonix

595 Market St., 12th Floor  
San Francisco, CA 94105  
<http://www.aonix.com>

**Circle 106**

### UNIX Connectivity Software Upgrade

GraphOn has updated its thin-client server-based line of connectivity software for accessing UNIX applications. The products—Go-Global 1.6 for Windows desktops, Go-Joe 2.3 for Java environments and Go-Between 1.1 for Windows Terminal Server/multiuser NT clients—now include a universal X server, called GlobalHost, which

## Try Out The Latest Software

**free software**  
**full demos**  
**software you can try**  
**new applications**  
**latest software**  
**games**

### Try It NOW!

Visit the Sun Solutions NOW! Web Site to find new and exciting solutions for the Solaris™ and Java™ environments by Sun's third-party software vendors. Check out the latest applications and stay current on new technologies as they hit the market—sometimes even *before* they're in full release.

### Over 500 Software Products

This is the largest collection of downloadable demos and trial software written for Solaris and Java on the Internet. We've added the complete Sun Solutions Catalog with over 14,000 product listings.

**[www.sun.com/downloads](http://www.sun.com/downloads)**

**Circle No. 26**





## New Products

enables UNIX X-based applications to be served up to multiple types of desktop clients.

Each new release also features a proprietary algorithm that encrypts a client's password and maintains the encryption during transit from the client to the server. This end-to-end encryption protects a user's password from being seen in transit, the company says.

Go-Global and Go-Between now share TrueType fonts between server and client, thereby reducing network traffic. Where bitmaps of the font characters were previously sent from the server to the client, this new approach installs a library of fonts on the X server and sends only the character name and information to the client, instead of the entire bitmap, GraphOn says.

Go-Global, Go-Joe and Go-Between each cost \$360 per seat and support a range of UNIX platforms, including Solaris, HP-UX, AIX and Linux.

### **GraphOn Corp.**

150 Harrison Ave.  
Campbell, CA 95008  
<http://www.graphon.com>

**Circle 107**

## Raritan Touts its Master Console

Raritan has announced MasterConsole SMX (Sun multiuser matrix), a line of keyboard-video-mouse (KVM) switches. MasterConsole SMX enables one, two or four simultaneous users to control multiple Sun Microsystems Inc. servers using a Sun keyboard, monitor and mouse, the company says.

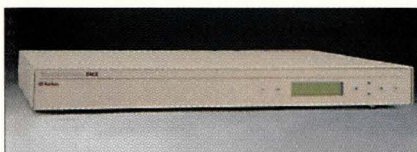

MasterConsole SMX comes with an on-screen user interface for simple operation and system management. It is capable of storing up to 60 user names, each with personalized operating profiles and optional passwords for security, Raritan says. Additional security is provided by a multilevel system that ensures authorized user access to each server.

MasterConsole SMX comes in three models: SMX18, which controls eight

Sun servers from one user console; SMX28, which controls eight Sun servers via two user consoles; and SMX416, which controls up to 16 Sun servers from one to four user consoles. Units can be cascaded for single- or multiuser control of up to 256 computers, the company says. The SMX18, SMX28 and SMX416 models cost \$1,895, \$2,495 and \$5,695, respectively.

### **Raritan Computer Inc.**

400 Cottontail Lane  
Somerset, NJ 08873  
<http://www.raritan.com>

**Circle 108**

## IVT Unveils Video Delivery Software

Instant Video Technologies (IVT) is now shipping Burstware 1.1, client/server video delivery software that is said to manage the transfer of cinema-quality video across all types of network.

Burstware is designed to conserve bandwidth while providing smooth uninterrupted broadcasts, the company says. It uses IVT's Faster-Than-Real-Time video/audio delivery mechanism, which reportedly sends out managed content "bursts" capable of staying ahead of the content consumed by clients.

The Burstware server runs on Windows NT and Solaris. It comes with a load-balancing feature for use with multiple servers. This allows one server to be removed from serving up data or to provide failover capability. The Burstware client is written in Java and can be configured to run with a Web browser or as a stand-alone application. It plays MPEG, QuickTime or MP3 files. A 100-MB server costs \$25,000. A subscription pricing model is also available for VARs; contact vendor for a quote.

### **Instant Video Technologies Inc.**

500 Sansome St., Ste. 503  
San Francisco, CA 94111  
<http://www.burst.com>

**Circle 109**

## More Memory for SGI Workstations

Camintonn is now shipping memory expansion for SGI's Visual Workstation 320 and 540. The new memory expansion is fully integrated and interoperable for both Visual Workstation models and



is designed to increase the memory to 1 GB for the 320 and 2 GB for the 540 in increments of 128, 256 and 512 MB. Pricing for the added memory starts at \$345.

### **Camintonn Corp.**

22 Morgan  
Irvine, CA 92618  
<http://www.camintonn.com>

**Circle 110**

## Tandberg Unveils DLT Autoloader

Tandberg's DLT Autoloader is designed to provide an affordable and compact storage solution for security critical data for large workgroup environments. The Tandberg DLT Autoloader uses one DLT4000 or DLT7000 drive and accommodates up to seven cartridges, with capacities ranging from 140 GB to 490 GB. The drive supports transfer rates of up to 36 GB/hour.

The product is available in rack-mount and desktop versions with a compact footprint that allows two loaders to be installed side-by-side in a standard 19-inch rack. All Autoloader functions can be controlled via either a front-panel LCD or host software. It supports various network and operating systems, including Linux, NetWare and Windows NT, and is priced starting at \$5,163 for the DLT4000 version and \$7,919 for the DLT7000 version.

### **Tandberg Data Inc.**

2685-A Park Center Drive  
Simi Valley, CA 93065  
<http://www.tandberg.com>

**Circle 111**

## Corporate Portal Development Tool

Rio 3.2 from DataChannel is an eXtensible Markup Language (XML)-enabled tool designed to build dynamic two-way corporate portals with input



## New Products

(publishing) and output (retrieval) capabilities, making intra/extranets easier to use, integrate, manage and support, the company says.

New features have been added to Version 3.2 to ensure smoother deployment in a secure environment and to improve document management, the company says. An extensible security architecture supports standard directory services, an API to access proprietary directory services and integrated Secure Sockets Layer (SSL) support. Content creators can now remove all files associated with a channel or folder by simply deleting that channel or folder, and all URLs and documents associated with it are automatically deleted from the server, DataChannel says.

An extra feature is the XML Java parser, which allows developers to access and manipulate data between applications across different platforms, including UNIX and Windows NT. DataChannel Rio is priced starting at \$14,500 for the UNIX version and

\$9,500 for the Windows NT version (a free 45-day trial version is available for download).

### DataChannel Inc.

600 108th Ave., N.E., Ste. 900  
Bellevue, WA 98004

<http://www.datachannel.com>

Circle 112

## RAS Card Supports Solaris

Chase Research, a data communications company specializing in remote access hardware, has announced support for Solaris on Intel in its remote access services (RAS) multimodem card. The Chase PCI-RAS Multimodem card is a V.90 RAS and computer/telephony integration (CTI) product that comes in either 4- or 8-port versions. It can be used to create remote access servers on Intel-based Solaris systems and supports 56-Kb/s V.90 standards on all channels. Data compression is achieved via the V.42bis standard with V.42 error correction, the company says. Pricing for the

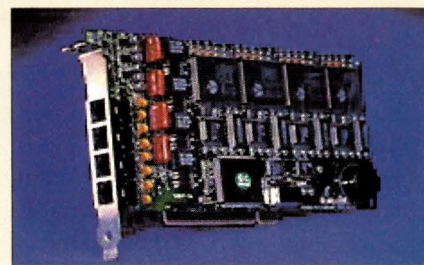

PCI-RAS Multimodem card starts at \$1,195 for the 4-port version and at \$1,895 for the 8-port version. Drivers are available for Solaris (Intel and SPARC), SCO UNIX, Linux and Windows NT.

### Chase Research Inc.

545 Marriott Drive, Ste. 100  
Nashville, TN 37214

<http://www.chaser.com>

Circle 113

## APC Repackages Redundant Switches

American Power Conversion (APC) has introduced its redundant switch packages as independent products. Previously, these switches were only

# Server/Workstation REPRINTS

Keep up with the latest in Sun technology with the best minds in the industry. Use reprints to promote, inform, and sell.

**Reprint Management Services™** provides you the opportunity to obtain reprints of reviews, articles, and features in **Server/Workstation Expert**.

High-quality editorial reprints will help your company in many ways:

- Increased EXPOSURE for your product or service
- Credible, believable information that consumers TRUST
- Excellent SALES tool for trade shows, mailings and media kits
- Powerful EDUCATIONAL RESOURCE for consumers and employees

Reprints are completely customized to your needs. Call today for additional information!

### CATHY HENSEL

Reprint Operations Specialist

### REPRINT MANAGEMENT SERVICES™

147 West Airport Road, P.O. Box 5363  
Lancaster, PA 17606

Phone: (717) 560-2001

Fax: (717) 560-2063

Email: [sales@rmsreprints.com](mailto:sales@rmsreprints.com)

## A LOOK AHEAD

### SEPTEMBER

#### UNIX Training

- Outsourcing
- CBT
- Web-Based

*WebServer Supplement: The Web Meets OLAP*

### OCTOBER

#### Java

- Server-Side Applications
- Enterprise Development Tools
- Security

*WebServer Supplement: Workflow Tools*

### NOVEMBER

#### Smart Documents

- Imaging
- Multimedia
- Scientific Visualization
- Data Analysis Applications

*WebServer Supplement: Development Tools*



## New Products

available as part of the Smart-UPS 1400/High-Availability Redundant Switch package; now APC's redundant switch is available in four models designed to use identical Smart-UPS (uninterruptible power supply), ranging from 700VA to 3000VA in 120V and 208V environments.

APC says it has enhanced its redundant switch to work with existing rack, tower, extended-run or rack-mount extended-run Smart-UPS. It requires only 1U of rack space and works with servers running Solaris, NetWare or Windows NT. The switch monitors power quality from both the primary and redundant UPS, each of which can be plugged into separate AC circuits, the company says. Furthermore, APC's redundant switch is said to shift the load to the redundant Smart-UPS when it detects a potential disruption to

the load, for example, during a severe power surge.

The redundant switch also sends status messages via the UPS-to-UPS management software, which in turn alerts IT professionals when it has detected a problem. Pricing for APC's redundant switches starts at \$415.

### **American Power Conversion Corp.**

132 Fairgrounds Road  
West Kingston, RI 02892  
<http://www.apcc.com>

**Circle 114**

### **Software to Build Component-Based Apps**

Prolifics, a Jyacc Inc. company, has released Panther, a new software family for building component-based applications. Panther, which supports COM, CORBA and Enterprise JavaBeans com-

ponent models, allows developers to combine custom-built components with prebuilt components from third-party sources to create new applications, the company says.

In addition, Panther comes with tools for the development and deployment of Web-based applications, the company says. Developers can use Panther's Integrate Application Server to dynamically create HTML, as well as write business logic in Java. Panther supports Win32, UNIX and Linux platforms. Base pricing starts at \$4,995 and includes Web development capabilities, COM/DCOM support and a one-year maintenance agreement.

### **Prolifics**

116 John St., 20th Floor  
New York, NY 10038  
<http://www.prolifics.com>

**Circle 115**

## Upgrades, Enhancements, Additions...

■ SolutionSoft Systems has updated its testing tool for UNIX and NT systems. Time Machine is a date simulation program that reportedly enables IT managers to simultaneously test an application's response up to 200 times on the same system without interfering with normal operations. The latest version, Release 3, includes a new contingency planning tool called "program encapsulation," which makes it possible to modify specific noncompliant programs to interpret dates as if they were in a previous year. Encapsulated programs change all years after 2000 into past years containing the same date/weekday pairings as the actual year so date-related information can be correctly processed, the company says. It can be used as either a stop-gap measure or as a long-term solution for programs that cannot be made 100%-compliant. Both encapsulated and nonencapsulated Y2K-compliant programs can operate simultaneously on the same system, the company says. Time Machine 3 is available for systems running HP MPE/iX, HP-UX, NCR MP-RAS, Solaris, AIX and Windows NT. Pricing starts at \$2,000 per CPU. **SolutionSoft Systems Inc.**, 2350 Mission College Blvd., Ste. 777, Santa Clara, CA 95054, <http://www.solution-soft.com>. **Circle 116**

■ Version 5.0 of Innosoft International's Innosoft Directory Services (IDS) product suite is said to be able to support thousands of concurrent client connections and deliver more than 550 typical queries per second on low-cost, single-processor hardware (scaling up with additional processors). It features "fall-back multimaster replication" technology based on Lightweight Directory Access Protocol (LDAP) v3, which provides for the reconciliation of data between a primary and secondary master server should either become

unavailable for a period of time, Innosoft says. It also provides "second-level slave replication" so that one slave server can receive incremental updates from another slave server. All configuration and management of masters and slaves is Web-based and replication can be configured to use Secure Sockets Layer (SSL) for server-to-server authentication and encryption of data streams for secure replication over public networks. IDS is available for Solaris 2.6/7, Tru64 UNIX 4.0, AIX 4.3 on PowerPC, Red Hat Linux 5, Open VMS 7.1 and Windows NT. Pricing starts at \$1,800 for 1,000 entries. **Innosoft International Inc.**, 1050 Lakes Drive, West Covina, CA 91790, <http://www.innosoft.com>. **Circle 117**

■ SoftTech Solutions' On-Line! Detective 11.0, a system support tool for personnel supporting Sun Microsystems Inc. workstations and servers, reportedly offers easier navigation and improved product coverage. It covers troubleshooting, root cause resolution, configuration rules and guidelines, as well as many other Solaris-related issues needing quick and accurate answers and information. New navigational aids include hot links, full-color photographs, a search function and a site map. On-Line! Detective supports all Sun workstations from the SPARCstation IPC to the Ultra 60. In terms of servers, it includes the SS1000, SC2000, Enterprise 3000-6000, Enterprise 3500-E6500 and Enterprise 250 and 450. It also covers storage arrays, including the StorEdge A5000. Pricing starts at \$4,580 for a single-user license, plus a \$990 annual subscription fee after the first year. A license for 50 users costs \$85,500, plus a \$26,000 annual subscription fee. **SoftTech Solutions**, 3525 Elizabeth Lake Road, Ste. A, Waterford, MI 48328, <http://www.stsolutions.com>. **Circle 118**



# Server/Workstation Marketplace

The high impact, cost-effective and powerful advertising section reaching over **100,000** technical product specifiers and buyers.

To advertise call Carol Flanagan at **(508) 839-4016** Email: [caflanag@aol.com](mailto:caflanag@aol.com)

## BACK UP INTO THE NEXT CENTURY



Applied Digital Systems (ADS) has been providing computer solutions since 1984. And as a Sun Value Added Reseller, our Ultra™ based solutions give unmatched performance for all your computing needs.

ADS offer Solaris™ based on-line catalog software, RAID disk arrays and tape library backup products. Our DLT and AIT tape libraries include software to automate backup for Sun and other UNIX platforms.

Plus, our technicians are Sun Competency 2000™ trained to give you unparalleled technical support and service for maximum efficiency and reliability.

Call ADS at **1-800-724-2692** for your Sun or data storage upgrade requirements.



### APPLIED DIGITAL SYSTEMS INC.

30 Liffbridge Ln. E. • Fairport, New York • 14450-1526 • 716-377-7000  
Rochester • Boston • D.C. • Houston • Chicago  
Web Site: [www.adsys.com](http://www.adsys.com) • GSA# GS35F-0127D

Circle No. 402

## Nu Products from Nu Horizons!



Why take a chance losing a valuable customer with used product?

No worrying about Warranties!

Nu Horizons Electronics Corporation, an **Authorized Distributor**, is your source for new and original product offered by Sun Microsystems, microelectronics group.

Motherboards, CPU's, Processor Modules, Graphics and Networking Cards, Solaris OS, JAVA OS, and Memory Modules...Also Performance Technologies and Viking Memory.



NU HORIZONS ELECTRONICS CORP.

Call 1-877-NUHO-SUN

Open from 9:30AM to 8:00PM EST  
[www.nuhorizons.com/sunsales](http://www.nuhorizons.com/sunsales)  
EMAIL: [sunsales@nuhorizons.com](mailto:sunsales@nuhorizons.com)

Circle No. 346

## MICHAURA SYSTEMS CORPORATION

...the upgrade specialists

## Buy... Sell... Trade Sun Microsystems and more...

- Systems
- Spares
- Lantronix
- Best Power
- Repairs/Advance Replacements
- Peripherals

Michaura Systems Corporation  
2 Henshaw Street  
Woburn, MA 01801

Contact us today!

Tel: (781) 937-0010  
Fax: (781) 937-0808  
email: [sales@michaura.com](mailto:sales@michaura.com)  
URL: [www.michaura.com](http://www.michaura.com)

All trademarks are the property of their respective owners.

Circle No. 330



## UNIVERSAL CAPITAL FUNDING

SUN MICROSYSTEMS  
WORKSTATIONS

PRINTERS SERVERS MEMORY  
OPTIONS DISK TAPE

**800-883-9339**

BUY • SELL • RENT • LEASE •  
UPGRADE • EXCHANGE

UNIVERSAL CAPITAL FUNDING

15695 Medina Road, Plymouth, MN 55447  
VOICE (612) 551-9309 FAX (612) 551-9311  
EMAIL: [lyonts@winternet.com](mailto:lyonts@winternet.com)

Circle No. 320



## Comtek Computer Systems

Specializing in :

# SUN

SUN Microsystems & Peripherals

In-house OEM Depot Repair

Same Day Advance Exchanges

Spare Parts & Systems Sales

System Lease and Upgrade Programs

Inventory Mgt Programs

- Same day shipping
- One year warranty
- In house technical support
- Authorized Software Support Provider Agent
- On hand inventory
- Customized supply solutions to meet your needs
- **We can handle all your SUN needs**

### Comtek Computer Systems

"The first choice in SUN Support"

Give us a call so we can put our highly trained staff to work for you.

1-800-823-4450

WWW.Comtekcomsys.com



Circle No. 376

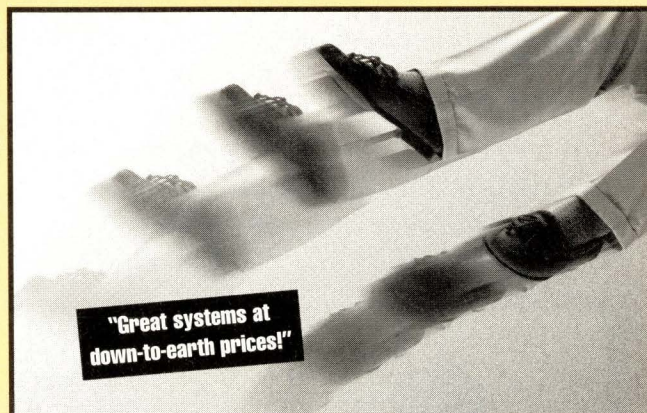

## Customer Blown Away By Low Prices

Work Stations • Servers • Peripherals • Parts  
Sales • Rentals • Leases • Exchanges • Repairs  
Maintenance • 120 Day Warranty

Call today to buy, sell or trade SUN and  
Silicon Graphics equipment with Security!



2340 County Road J • White Bear Lake, MN 55110  
651/227-5683 • FAX: 651/223-5524 • seccomp@seccomp.com

Circle No. 314

## CD-R for SUN

The **GEAR™** product line offers state-of-the-art CD-Recordable software and enables System Administrators to:

- distribute data on cross platform media
- archive data safely and inexpensively
- cut patches and updates to CD
- create custom audio and video CDs

**GEAR** supports the most extensive number of optical file formats, including ISO 9660 with RockRidge extensions. **GEAR** products are compatible with the latest CD-R technology from all major manufacturers. We support multiple UNIX versions including AIX, Digital UNIX, HP-UX, IRIX, and Solaris.

### GEAR Software, Inc.

1 (877) 237-4327

www.gearcdr.com

The leader in UNIX CD-R  
software for more than 10 years.

Circle No. 361



## E.L.I. SYSTEMS inc.

Used SUN Equipment

139 Hampshire St., Cambridge, MA 02139

Design Your Own System or  
Purchase Parts Individually

### Select a GRAPHICS CARD

501-1845 ZX F/B	\$595
501-2253 TX4 F/B	595
501-2325/2922 TX1 F/B	175
Creator 2D/3D	375/625

### Start with a SUN BASE

E450 Enterprise	\$10,600
Ultra 1/140/170	2,300/2,500
Ultra 2	5,300
Sparc 20	550
Sparc 10	275
Sparc 5 70/85	500/600
Sparc 5 110/170	700/1,700

### Remember MEMORY

X164P 64 MB SP 20/10	\$250
X164F 64 MB SP10	250
X132P 32 MB SP 20	150
X132M 32 MB SP5	175
X116F 16 MB SP10	25
501-1739 4MB S2/1/IPC	15
3 <sup>rd</sup> - Sparc 5, 32 MB	110
3 <sup>rd</sup> - Sparc 10/20/Ultra, 32 MB	120
3 <sup>rd</sup> - Sparc 10/20/Ultra, 64MB	225

### Add a MONITOR

16" Sony color	\$175
17" Sony color	400
19" Sony color	250
20" Sony color	525

### What capacity DISK

Seagate 1GB N/WC	\$175/225
Seagate 2.1 GB N/WC	280/295
Seagate 4.2 GB N/WC	325/350
Seagate 9.0 GB N/WC	550

### Choose a CPU

200/300 Mhz, Ultra 2	\$1,000/3,100
501-2352/2562 SM51	250
501-2752/2769 SM61	350
501-2953 SM81	425
Ross 125 Mhz/512K	new 1,500
Ross 150 Mhz/512K	new 2,000
Ross 180 Mhz/512K	new 2,100
Ross 200 Mhz/512k	new 2,200

### SYSTEMS SPECIALS

S20TX1-61-64-P46 19"cm	\$1,800
S10GX-41-64-P46 19"cm	965
S5FX1-70-64-P46 16"cm	1,200
A11-UBA1-1A-064AB 20" cm	3,785

PHONE 1-800/447-1156  
FAX 617/354-1417

E-MAIL sunsales@eli.com  
WEB http://www.eli.com

Circle No. 363



# Remote Trouble-Shoot & Reboot

- ✓ Dial-up and telnet access to Remote Sites
- ✓ Select Multiple Console/AUX Ports
- ✓ Reboot power on selected devices

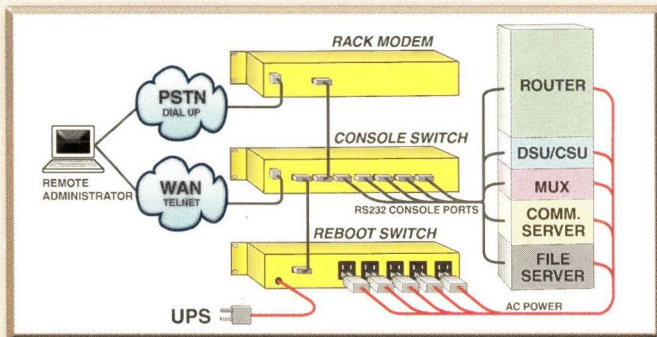

When it comes to Remote Site Management, no one offers more choices to access multiple console/AUX ports and/or reboot power than NetReach products from Western Telematic. We offer the flexibility you need to mix and match equipment for small or large remote management strategies. NetReach products are now installed in thousands of network sites world wide. Our customers know they can depend on our superior quality and reliability for their mission-critical operations.



### Console/AUX Port Managers

Remote access to multiple RS-232 Console/AUX Ports

- TCP/IP (telnet) and dial-up (modem)
- Continuous off-line buffering
- Password Protected
- Any-to-Any Port Matrix Switching
- AC or -48V DC power options
- Various models from 4 to 64 ports



### Intelligent Remote Power Switches

Reboot "locked-up" network equipment

- AC and -48V DC versions
- Password, Site ID, Plug Labels
- On/Off/Reboot power switching



### Rack Mount Modem

Single modem for Dial-up access to console ports

- AC and -48V DC powered
- 33.6Kbps V.34+
- Requires only one 19" rack space

**wte** western telematic inc. (800) 854-7226 • www.wti.com

5 Sterling, Irvine, CA 92618-2517  
Facsimile: (949) 583-9514

Circle No. 324

## "WE'LL TRADE ANYTHING YOU HAVE TOWARD ANYTHING YOU NEED!"

**USED SUN-HP-DEC-EMC-CISCO-LUCENT-ETC.**

**Mainframes-Servers-Workstations-Storage-Networking**



**TriniComp**  
SYSTEMS

2 Centennial Drive, Peabody, MA 01960

fax: 978-531-6037

email: sales@trinicomp.com

**Call 978-531-7366**

**www.trinicomp.com**

All trademarks are property of their respective companies

Circle No. 420

## QUICK RESPONSE TO YOUR INFORMATION REQUESTS

For more information on the products/services advertised in this section, please circle the appropriate reader service number(s) on the reader inquiry card located elsewhere in this issue. OR

You can E-mail your requests for more information using the reader inquiry card numbers.

### Here's how:

E-mail address: BERKCOMP@AOL.COM

### Include

1. Magazine name and issue date
2. Your name and address
3. Reader inquiry numbers, separated by commas, for which you need more information.



## EXA-"Bitten"??

Extend your EXABYTE Warranty

EXB-820x, 12 hr Repair (6 mo war): \$ 250

"Hot Swap" Repair (6 mo Warr.): \$ 300

EXB-850x, 12 hr Repair (6 mo war): \$ 350

"Hot Swap" Repair (6 mo Warr.): \$ 400

## DLT-"Bitten"!!

DLT-2000, DLT 4000, DLT4700: Call

**SUN Microsystems W/S**  
Buy, Sell, Spare Parts, Repairs



West Coast Computer  
Exchange, Inc.  
11167-A Trade Center Drive  
Rancho Cordova, CA 95670

Call: 916-635-9340 or FAX: 916-635-9485

Catalog at Web Site: [www.wccx.com](http://www.wccx.com)

email: [sales@wccx.com](mailto:sales@wccx.com)

Circle No. 428

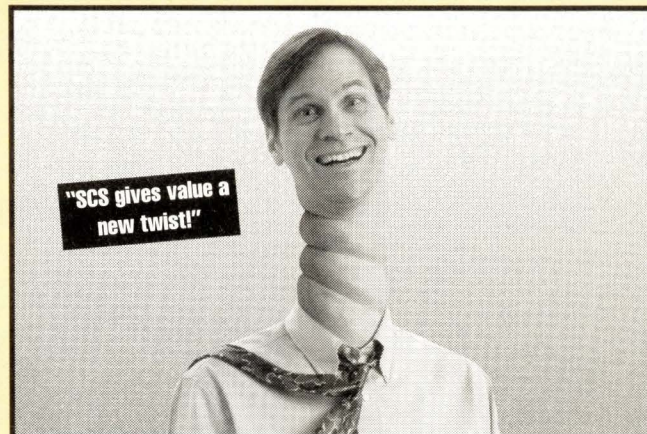

## Customer's Head Spins Over Great Deals

Call today to buy, sell or trade SUN and Silicon Graphics equipment with Security! Unbeatable value, unparalleled service -- no wonder so many heads are spinning!



2340 County Road J • White Bear Lake, MN 55110  
651/227-5683 • FAX: 651/223-5524 • [seccomp@seccomp.com](mailto:seccomp@seccomp.com)

Circle No. 401

# REMOTE YOUR DLT TAPE SYSTEM

The new LAZERLINK IV  
extends DLT tape systems  
up to 550 meters, for  
centralized tape backups.



APCON, Inc.  
17938 SW Upper Boones Ferry Rd.  
Portland, OR 97224, U.S.A.  
Phone (503) 639-6700  
Fax (503) 639-6740

e-mail:  
[info7@apcon.com](mailto:info7@apcon.com)

Call for free application information: 1-800-624-6808

Order on-line at:  
[www.apcon.com](http://www.apcon.com)



Circle No. 442



## LOOK!! SYSTEM INTEGRATORS/UPGRADERS

**SAVE \$ !! SAVE \$ !! SAVE \$ !! SAVE \$ !! SAVE \$**

Use our Hot Swap Carriers and \$ SAVE \$ on your data storage solution. We have much more. Please contact us ASAP.

1. SUN Sparc - 10, 1/2, 5/20
2. SUN Ultra Sparc - 1/2 Enterprise Series.
3. IBM Netfinity - 5000 5500, 7000.
4. SGI - Onyx, O2, Challenge, Octane.
5. COMPAQ - Proliant.
6. HP - Netserver.
7. GATEWAY/ALR - Servers.

**ARROWFIELD INT'L INC.**  
2812-A Walnut Ave.  
Tustin, CA 92780  
800-227-9628 (CA)  
800-322-0322 (AZ)  
WWW.arrowfieldinc.com



Circle No. 313

## LOWEST PRICES ON MEMORY

DEC, HP,  
IBM, SGI

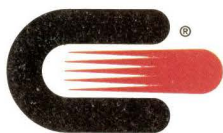

SUN, ROSS  
SIMMS, DIMMS

**Clearpoint Enterprises, Inc.**

Save time, money dealing directly with Manufacturer

**"If My Memory Serves Me Right  
...It Must Be Clearpoint"**

25 Birch St.  
Milford, MA 01757  
(800) 253-2778  
(508) 473-6111  
Fax (508) 473-0112  
www.clearpoint.com

Email: memory@clearpoint.com

Circle No. 362

## SPATCH

alphanumeric paging  
software for UNIX

Now UNIX and NT users  
can send text messages to  
alphanumeric pagers  
from a user, an application,  
or an E-mail system!



Interactive User Interface  
Event Monitoring  
IntraNet/Internet Paging  
E-Mail Forwarding  
Easy Application Integration  
**Starting at only \$199**



**THE HYDE COMPANY**  
5805 State Bridge Rd., Ste. G-327 Duluth, GA 30097  
phone 770/495-0718  
www.spatch.com  
spatch@hydeco.com

Circle No. 453

# RENT THIS SPACE

Call Carol Flanagan  
**(508) 839-4016**

## WANTED TO BUY

**SUN**  
Cash Paid Now For

All Enterprise Servers  
Ultra 1 & 2, 30 & 60  
SUN Disk & Disk Arrays  
Memory & Enterprise options

SAVE on OFF LEASE & REFURBISHED SYSTEMS  
Systems available for sale, lease or rent  
**CALL NOW FOR QUOTE**

**DATELEASE**

**(800) 456-6233**  
FAX (714) 632-9248  
sales@datalease.com

Circle No. 454

## SYSTEMS & CPU's

Ultra 1/170E-C3D-128mb-2.1GH-CD-FL1.....	\$ 3,995.00
Ultra 2/1167E-C3D-128mb-2.1GH-CD-FL1.....	\$ 6,995.00
Ultra 2/2300-C3D-128mb-2.1GH-CD-FL.....	\$12,995.00
Ultra 60-300mhz-C3D-128mb-4.2GB-20".....	\$ 8,495.00
Ultra 60-360mhz-C3D-128mb-4.2GB-20".....	\$ 9,195.00
Enterprise 450 Dual 300mhz.....	\$15,200.00
Enterprise 250 Dual 300mhz.....	\$ 9,995.00
Enterprise 4000 0Base.....	\$15,500.00
S5/170mhz-64mb-2.1GB-CD-FL.....	\$ 1,995.00
S5/85-32-1.05GB-TX1N.....	\$ 850.00
U2/200mhz.....	\$ 1,450.00
X1191A 300mhz Ultrasparc cpu.....	\$ 2,850.00

## MEMORY & DISKS

Sun 1GB S5520.....	\$ 135.00
Sun 2GB S5520/Ultra.....	\$ 275.00
Sun 4GB S5520/Ultra.....	\$ 565.00
Sun 9GB UltraArray.....	\$ 950.00
Sun X7004A 256mb kit/Ultra.....	\$ 995.00
Sun X7022A 256mb EX000/EX500.....	\$ 895.00
Sun X7023A 1GB memory kit EX000/EX500.....	\$ 3,995.00
Sun storage arrays 112/114/RSM/A5000.....	Call

## GRAPHICS

TX1/TX4.....	\$195/\$895
Creator/Creator3D.....	\$395/\$695

## ENTERPRISE

EX000 X2601A system board.....	\$ 5,495.00
EX000 X2611A I/O board.....	\$ 4,750.00
EX000 X2560A 336mhz/4mb cpu.....	\$ 6,995.00
EX000 X2550A 250mhz/4mb cpu.....	\$ 3,695.00
EX000 X2530A 250mhz/1mb cpu.....	\$ 1,495.00

**Upgrade your current monitors to 20" Sun Sony color for only \$295.00! While supplies lasts!**

Large inventory of hardware including spare parts, workstations, peripherals, memory, and 3rd party products.

Industry leading 18 month warranty

Check our web page for weekly specials - www.gshis.com

Email: sales@gshis.com

techinfo@gshis.com

\* Call for full product line and availability. \* Trades accepted, and purchase options available on all excess used equipment.



**GSH Intelligent Integrated Systems, Inc.**  
95 Fairmount Street Fitchburg, MA 01420  
Tel: (603) 529-7880 Fax: (603) 529-7884

Circle No. 353



# SUN-IBM-HP

NEW! Search our on-line catalog at  
[WWW.OSEXPRESSION.COM](http://WWW.OSEXPRESSION.COM)

SOFTWARE	LIST	OURS
WordPerfect 7.0 1st user	495	395
Netscape SuiteSpot Pro	6995	6145
VSI*FAX Gold Fax Software	2395	1995
VSI*FAX Gold Windows Client 10-user	590	520
FrameMaker 1-user (floating license)	2500	2295
Adobe Acrobat 1-user	295	245
Informix On-Line Dynamic Server 1-usr (min. 10)	1500	call
Informix On-Line WorkGroup Serv 1-usr (min. 5)	295	call
Informix 4GL Development 1-user (min 3)	900	call
Term Communications Software	695	595
LP Plus Print Manager/Spooler 4-printer	695	575
SoftWindows MS-Windows Emulator	549	475
Spatch alphanumeric paging SW 4-user	499	425
DoubleVision Remote Support S/W	795	665
Uniplex II+ (20-user)	5500	4895
Disk_Pak Disk Optimizer/Defragger	1495	1230
Cheyenne Arcserve/Open Backup S/W	1995	1395
Legato Networker Backup S/W	2500	1950
Hummingbird PC X-Server Win NT/95	545	395
Hummingbird Maestro NFS Server - Win NT	195	169

QUANTUM DLT TAPE LIBRARIES	LIST	OURS
160/320GB, 36GB/hr, autoloader, barcodes	n/a	6995
280/560GB, 36GB/hr, autoloader, barcodes	n/a	11495

OTHER HARDWARE	LIST	OURS
HP 8GB External 4mm DAT Tape Drive	1150	925
HP 24GB External 4mm DAT Tape Drive	1550	1195
HP Laserjet 8000N, 24ppm, 16MB, 10/100BT	3279	2895
Mannesman Tally MT-661 800lpm Line Printer	7999	6795
Seagate Cheetah 9.1GB Ext. Ultra Wide SCSI	1495	875
Plextor 32X External CD-ROM Drive	395	255
Young Minds CD-Studio (ntwk CD-writer Sys.)	8339	Call
DigiPortServer II 16-port Terminal Server	2395	1890

100's of other UNIX products available!

Other Platforms: SCO, SUN X86, WIN NT, DEC, SGI, DG

## Open Systems EXPRESS!™

Your direct source for UNIX,  
 Win NT & networking products  
 45 Whitney Road, Suite B8, Mahwah, NJ 07430

Free Shipping! **1-800-445-9292** Fast Delivery!  
 (call and ask for our free catalog!)

Fax: 201-847-8899 MC/VISA/AMEX/  
 E-mail: [sales@osexpress.com](mailto:sales@osexpress.com) DISC/V.C.O.D./Net.

Circle No. 413

# SERIOUS SUN SOLUTIONS

Remanufactured Sun Systems Full Technical Support  
 Complete Network Services Peripherals and Memory Upgrades  
**Kingston TECHNOLOGY CORPORATION**

1-800-842-4781



5980 Golden Hills Drive, Minneapolis, MN 55416  
 phone: (612) 512-3200 fax: (612) 512-1072  
 email: [sun@workstations.com](mailto:sun@workstations.com) [www.workstations.com](http://www.workstations.com)

Circle No. 333



## Customer Goes Ape Over Great Service

Call today to buy, sell or trade SUN and Silicon Graphics equipment with Security. Unparalleled service, unbeatable value - No wonder so many people are going ape.



2340 County Road J • White Bear Lake, MN 55110  
 651/227-5683 • FAX: 651/223-5524 • [seccomp@seccomp.com](mailto:seccomp@seccomp.com)

Circle No. 438

# ULTRAFAST SBus A/D

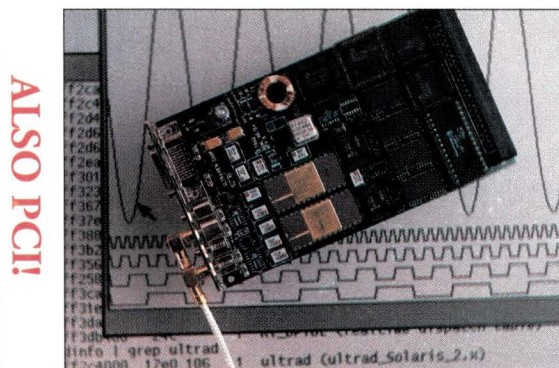

## 10 MHz DATA ACQUISITION

The ultimate 12-bit data acquisition board can acquire 8 Million A/D samples while *simultaneously* outputting 8 Million D/A samples and TTL vectors, all without CPU intervention.

Four analog inputs, twin 5 MHz 12-Bit A/D and D/A converters, 5 MHz TTL input/output vectors, and **huge 16 MB RAM** allow use in the most demanding scientific and industrial applications.

**ULTRAVIEW CORPORATION** email: [ultrav@worldnet.att.net](mailto:ultrav@worldnet.att.net)  
 34 Canyon View, Orinda, CA 94563 [www.ultraviewcorp.com](http://www.ultraviewcorp.com)  
 Telephone: (925) 253-2960 Fax: (925) 253-4894

Circle No. 375



# S O S



**AUTHORIZED DISTRIBUTOR**  
**••• IMMEDIATE SHIPMENT •••**  
**CREDIT CARDS OR PO'S ACCEPTED**

### IBM Disk Drives

Capacity	Ultra SCSI*	SSA*	FC-AL*
4.5GB	\$236	Call	N/A
9GB	\$366	\$482	\$700
18GB	\$824	\$860	\$1,127
36GB	\$1,548	Call	\$1,635

### Kingston Memory

Platform	32MB	64MB	128MB	256MB	512MB
SUN*	\$101	\$208	\$317	\$583	\$1,150
SGI*	\$160	\$209	\$262	\$484	\$1,017
IBM*	\$114	\$143	\$289	\$533	\$1,066
H-P*	\$82	\$189	\$450	\$774	\$2,111
NT*	\$54	\$110	\$213	\$533	\$1,133

\*Prices are examples for the indicated platform. A particular module for a specific model may differ in price. Prices are subject to change.

**Nordisk Systems, Inc.** • 7900 East Greenway Road, Suite 207 • Scottsdale, AZ 85260  
 Contact: e-mail: [sales@nordisk.com](mailto:sales@nordisk.com)  
 Telephone: 888-NORDISK (667-3475) or 480-922-1222 Fax: 480-922-7222

Web Sites: or or [www.nordisk.com](http://www.nordisk.com)

Circle No. 340

*DCG Computers your total solutions provider*  
**Sun Ultra Sparc, Alpha & Intel**  
 Check out our 2U case,  
**20 AXi Systems**  
 in a 6' space



SUPPORT FOR SOLARIS, LINUX, DIGITAL UNIX, OPENVMS, AND WINDOWS NT  
 Tel: 603-421-1800 Fax: 603-421-0911  
 For a complete list of solutions visit us at [www.dcginc.com](http://www.dcginc.com)  
 All trademarks and registered trademarks are the sole property of their respective owners

Circle No. 322

**AROUND  
 THE CLOCK**  
*and*  
**AROUND  
 THE WORLD**

We're  
 Your Company's  
 Hottest Source For  
 Buying, Selling, or  
 Trading Sun™ Equipment.  
 For Over 15 Years...

**Results Without The  
 Headaches. Guaranteed.**

Call today:  
 248.528.6565  
 Fax: 248.524.1449

Or for easy ordering **ANYTIME...**  
 Web: [www.virtualtechnology.com](http://www.virtualtechnology.com)  
 E-mail: [virtual@wwnet.com](mailto:virtual@wwnet.com)

**VIRTUAL TECHNOLOGY**  
 Computer Products and Services

Circle No. 331



## Discover Solar Systems with hundreds of Suns.

Refurbished **Sun Microsystems** equipment at great prices. Fully-tested inventory on hand, same-day shipping, satisfaction guaranteed.



- Workstations & Servers
- Upgrades & Parts
- Storage Options
- Rental & Leasing Available
- Cycle 5 Master Reseller
- SunSoft Authorized Reseller



To buy or sell,  
**1-800-253-5764**

Ext. 220

Outside U.S. call 1-425-222-7588 Fax 425-222-7388

<http://www.solarsys.com>



Circle No. 411

# visual thought®

Diagramming Flowcharting

### Features:

- cross-platform (UNIX & Windows)
- FrameMaker MIF export
- rubberbanding connections
- advanced flowcharting features
- drag-and-drop shapes
- hierarchical documents
- "smart pasting"
- 100 levels of undo

### Used worldwide by:

Lucent, Ericsson, Hewlett-Packard, Motorola, Siemens, Nortel...and more

- flowcharts
- software design
- technical graphics
- network diagrams
- web imagemaps
- org charts

## Visual Solutions

[www.confluent.com](http://www.confluent.com)

free download | use code AE13

1-800-780-2838

©1998 Confluent, Inc. All rights reserved. Visual Thought, the Visual Thought logo, Confluent, and the Confluent logo are trademarks or registered trademarks of Confluent, Inc. All other names are the properties of their respective holders.

Circle No. 447

## JUST OFF LEASE

### ULTRA 60

### \$325/mo\*

360MHz Processor  
128Mb memory • 9.0Gb Disk  
Creator 3D

- Lease for 36 months with \$1.00 buyout or purchase for \$8,950. Subject to supply on hand and credit approval.



**(800) 456-6233**

FAX (714) 632-9248  
[sales@datalease.com](mailto:sales@datalease.com)

Circle No. 455

To Advertise Or For More Information Concerning The

## UNIX/NT Recruitment Opportunities Section

Please call Carol Flanagan at  
**(508) 839-4016**

## Sun & HP

# BUY SELL TRADE

## Workstations and Servers

Boards Monitors Disks Tapes Mass Storage Solutions

- ◆ Same Day Shipping
- ◆ Competitive Pricing
- ◆ Custom Configurations Available

### DEPOT REPAIR CENTER

- ◆ 30% To 50% Cost Savings
- ◆ One Year Warranty
- ◆ Overnight "Swap" Service



**ACC, Inc.**

### AdvanTec Computer Company

4125 Business Center Drive Fremont, CA 94538  
Phone: (510) 440-9700 Fax: (510) 440-9709  
E-mail: [sales@advanteco.com](mailto:sales@advanteco.com)  
<http://www.advanteco.com>

Circle No. 439





## R/S 6000

SAVINGS UP TO 75%

- Whole machines
- Parts
- Repairs
- Logistics management
- Features
- Upgrades

# 800-328-7723

Jeff Karschnik x5760  
email: jeffk@expresspoint.com

Tim Balko x5706  
email: tbalko@expresspoint.com

Circle No. 372

# RS/6000

NEW • REFURBISHED  
BUY • SELL • LEASE  
SYSTEMS • PARTS  
PERIPHERALS



## Worldwide Trade Corporation

5253 Edina Industrial Blvd.  
Edina, MN 55439  
Call (612) 831-8094  
Fax (612) 831-7018

Circle No. 342

## Server/Workstation Marketplace

### MEMORY UPGRADE SOLUTIONS FOR YOUR SERVERS & WORKSTATIONS

**COMPAQ**

PROLIANT SERVERS  
&  
PROFESSIONAL  
WORKSTATIONS

**Sun**

ENTERPRISE  
3000-6000  
64MB, 256MB, 1GB KIT  
ULTRA  
1, 30, 60  
128MB, 256MB KIT

**SiliconGraphics**

OCTANE  
64MB, 128MB, 256MB  
512MB KIT  
O2  
64MB, 128MB, 256MB KIT

**DELL**

POWER EDGE 6300 SERIES

**IBM**

NETFINITY  
INTELLISTATION  
RS/6000

**Gateway™**  
E3200

Tel: (949) 454-9888  
Fax: (949) 454-9499  
email: corporate@kingmax.com

**hp** HEWLETT®  
PACKARD  
3000, 9000

**KINGMAX**

All company logos are registered trademarks of their respective trademark owners.

Circle No. 379

The  
one  
and  
only  
source  
for  
all  
your  
IT  
needs



ONE SOURCE CORP

**WWW.**  
**onesourcecorp.**  
**com**

Circle No. 345



# Why Pay More?

# IBM RS/6000

SAVE OVER GOING DIRECT TO IBM

FULL LINE SUPPLIER / ALL SYSTEMS IN STOCK



**National Data**

EMAIL: [RS6000@natdata.com](mailto:RS6000@natdata.com)

call for *free* CATALOG

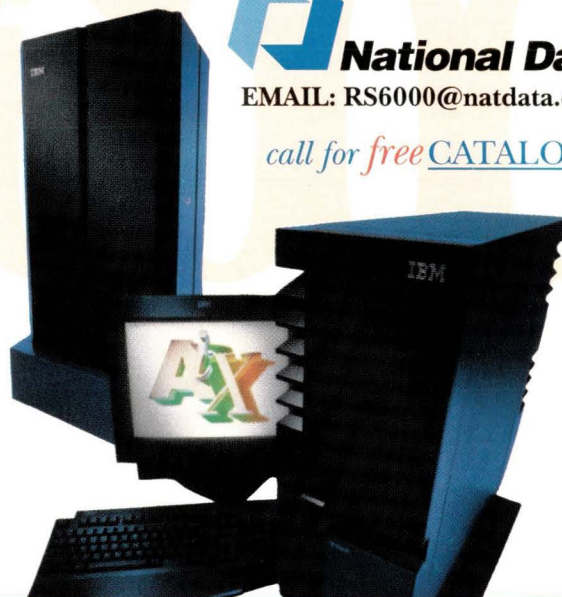
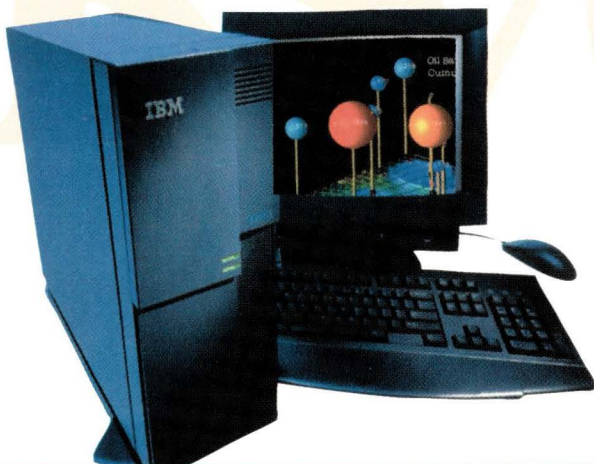

**CALL : 800 - 406 1811**

Circle No. 343

**RS/6000**

BUY ~ SELL ~ LEASE

- NEW & RECERTIFIED RS/6000 PRODUCT
- IN-HOUSE TECHNICAL SERVICES
- SAME DAY SHIPPING (UNTIL 7:00 PM CST)
- UPGRADES - PARTS - FEATURES
- KINGSTON PRODUCT DISTRIBUTOR
- SHORT-TERM RENTAL/LEASE



**1.800.294.4362**

[EVOLVING@EVOLVINGSOL.COM](mailto:EVOLVING@EVOLVINGSOL.COM)

[WWW.EVOLVINGSOL.COM](http://WWW.EVOLVINGSOL.COM)

3989 COUNTY ROAD 116 ▼ HAMEL, MN 55340 ▼ 612.516.6500 ▼ FAX: 612.516.6555

**EVOLVING**

SPECIALISTS IN RS/6000

PRODUCTS & SERVICES

**SOLUTIONS**

Circle No. 357

**EXPRESS**  
Computer Systems

BUY - SELL - RENT  
**SUN MICROSYSTEMS**  
**IBM RS/6000**

- SYSTEMS
- DISK UPGRADES
- MEMORY UPGRADES
- PERIPHERALS
- PARTS
- PROCESSOR UPGR.

**800-327-0730**

**Keith DiCarlo Ext. 459**

**Fax: 949-474-9250**

[kdicarlo@ecsunix.com](mailto:kdicarlo@ecsunix.com)

Circle No. 404



**BUY - SELL**

# SUN

**& DATA GENERAL**

---

**PARTS - DISKS**  
**MEMORY- SERVERS**  
**WORKSTATIONS**

---

**AMES SCIENCES, INC**  
 501 SOUTH STREET, EASTON, MD 21601-3846

**410-820-8100**  
**FAX 410-820-8179**

Circle No. 348

## RENT to OWN

**SUN®  
E450**

4 x 300MHz Processors  
 512Mb memory  
 PGX 8Bit  
 8 x 4.2Gb Disk  
 12x CD-ROM • Floppy

**\$998/mo\***

\*Lease for 36mo. then it's yours for only \$1.00 - or - purchase for \$28,500.  
 \*Just off lease from a major finance co. Subject to supply on hand. Lease subject to credit approval.

**DATALEASE**

**(800) 456-6233**  
 FAX (714) 632-9248  
 sales@datalease.com

Circle No. 352

**BONUS TO**  
**Server/Workstation Expert**  
**ADVERTISERS OF THE**  
**FOLLOWING ISSUES**

- **AUGUST 1999 ISSUE**  
**Siggraph 99**  
 Los Angeles, CA
- **OCTOBER 1999 ISSUE**  
**Fall Internet World**  
 New York, NY
- **USENIX 2nd Symposium on**  
**Internet Technologies and**  
**Systems**  
 Boulder, CO

When It Comes To Computers...



We Make The Sun Rise Again

**800-566-4SUN**

Sell-Buy-Rent-Exchange



Sun Workstations/Servers  
 IBM RS6000 Business Partner  
 Sun 20" Monitor Repair  
 Sun Parts & Peripherals  
 SONY Authorized Dealer  
 Netscape Solution Experts

"A Family Business"  
 101 First Street Utica, NY 13501  
 Phone: (315) 724-2209 FAX: (315) 724-0794  
 www.ccnny.com



Circle No. 367

# RENT THIS SPACE

Call Carol Flanagan  
**(508) 839-4016**

## ATLANTIC

**PERIPHERAL SYSTEMS**  
 "SUPER" SPARC™ VALUES!

**MEMORY**

64MB SS20	\$250
64MB Ultra 1	\$275
128MB Ultra 2	\$495
256MB Kit Ent. Server	\$1,095

**STORAGE**

2.1GB SGT 'cuda Int/SCSI	\$425
4.3GB SGT 'cuda Int/SCSI	\$650
9.0GB SGT 'cuda Int/SCSI	\$950
9.0GB SGT Cheetah Int/SCSI	\$1,295

**SPECIALI**

23GB SGT Elite Int/SCSI	\$1,895
-------------------------	---------

**WORKSTATIONS**  
 SS Ultra 1, 2—CALL FOR QUOTE!  
 NOW! VISIT OUR WEBSITE!  
 WWW.ATLANTICPS.COM  
 912-929-7099 FAX 912-929-7098  
 E-MAIL: atlanticps@mindspring.com

Circle No. 316

## MONITORS • MONITORS • MONITORS



# MonTech

Monitor Technology Inc.

*Your Complete Monitor Solution*

### SERVICE • EXCHANGE • SALES

**Authorized Service Provider**  
**Sony Mitsubishi Wyse NEC (PGS)**  
 ALL MONITORS REFURBISHED TO OEM SPECIFICATIONS  
 AND CARRY A 6 MONTH WARRANTY  
 HUNDREDS OF MONITORS IN INVENTORY

**Monitor Technology Inc.**  
 978-454-6666 PHONE 978-454-8765 FAX

**SUN • HP • SGI • IBM • SONY**

Circle No. 431



# Anatomy of a World Class KVM Switch

**High Resolution Video**  
NTI's Matrix KVM Switches support 1600x1200 video resolution with no image degradation or loss of signal to 250 feet — guaranteed.

**True Matrix Design**  
NTI's True Matrix KVM Switch design allows up to 8 users independent or simultaneous non-blocking access to 32 computers on a single switch.

**Multi-Platform Support**  
Our Matrix KVM Switch can be used as either a single or multi-platform switch and supports all PS/2 style PCs, RS6000, HP9000, Mac, Sun and Sun's ULTRA systems.

**Cables & Connectors**  
Our Matrix KVM Switches use standard cables for easy, no-hassle "Plug-and-Play" setup and support the new USB format as well as standard PC, Sun and Mac connectors.

**Microprocessors**  
Dedicated microprocessors in NTI's Matrix KVM Switches provide reliable control and performance, preventing CPUs from locking up or freezing.

**On Screen Display**  
The optional OSD enables the user to select network servers by name or port number. The display is OS and software independent, and is equipped with password protection.

[www.nti1.com](http://www.nti1.com)

**At NTI, We Know That Your Reputation is Depending On Our Performance.**

As a network professional, you need to be certain you can rely on your switching peripherals to do what the manufacturer says they can. Not some of the time, but all the time, every time.

At Network Technologies, we deliver performance, not excuses. If you need to streamline your server center operation, combine Windows NT and UNIX systems in an enterprise environment or just eliminate the confusion and expense of redundant keyboards and mice, NTI's Multi-User, Multi-Platform Matrix KVM Switches will provide you with the reliable and compatible switching solutions you need.

At NTI we stand by our promises, because it's not just your reputation that's on the line.

**NTI Network Technologies Inc**  
1275 Danner Dr • Aurora, OH 44202 • 330-562-7070 • 800-742-8324  
FAX: 330-562-1999 • E-Mail: [sales@nti1.com](mailto:sales@nti1.com)



Mac and the Mac logo are trademarks of Apple Computer, Inc., registered in the U.S. and other countries.

Circle No. 366

**FacetWin**

*The ultimate in Windows to UNIX connectivity*

FacetWin makes Windows®95/NT® to UNIX integration easy and affordable. Just ask for a **FREE EVALUATION** copy of FacetWin, or check out our web site at [www.facetcorp.com](http://www.facetcorp.com).

- File & Print Services**  
No need for NFS or ftp... files and printers on UNIX systems simply appear as local resources to your PC, and are ready to use!
- Terminal Emulation**  
World class terminal emulation from the terminal experts that brought you FacetTerm™. Set up a UNIX application with a Windows icon in one minute!
- Graphical Administration**  
Graphical properties administration from Windows with context sensitive help.
- Plus, check out these cool features:**
  - PC Backup/Restore
  - Modem Server
  - Remote Computing Support
  - Email Server

**FacetCorp**

tel: 800/235-9901 • 972/985-9901  
fax: 972/612-2035  
[info@facetcorp.com](mailto:info@facetcorp.com)  
[www.facetcorp.com](http://www.facetcorp.com)

FacetWin is a registered trademark of FacetCorp. Other names are properties of their respective holders.

Circle No. 421

**Gulfcast Workstation Corp.**  
*Enterprise Server Specialists!*  
**SUN Microsystems**

**BUY SELL Rent LEASE**

**CALL FOR CURRENT PRICING**  
**(800) 587-7882**

2210 Tall Pines Drive • Suite 220 • Largo, FL 33771  
Phone: (727) 524-9668 \* Fax: (727) 524-9138

Circle No. 422



# ADVERTISERS' INDEX

The Ad Index is published as a service to our readers.  
The publisher does not assume any liability for errors or omissions.

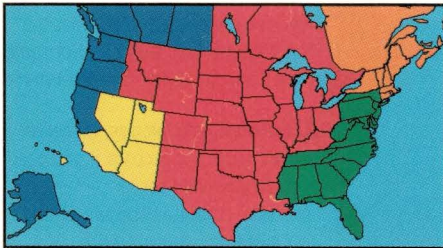

## New England/Upstate New York/ Eastern Canada

**CAROL A. FLANAGAN**  
80 Worcester St., Ste. 9  
North Grafton, MA 01536  
**Phone: (508) 839-4016**  
Fax (508) 839-4226  
**Email: caflanag@aol.com**

## New York/Mid-Atlantic/ Southeast

**JOANNA PARKER**  
18 Stephanie Drive, Ste. 3  
Stirling, NJ 07980  
**Phone: (908) 542-0789**  
Fax: (908) 542-0782  
**Email: joanna@cpj.com**

## Mid-West/Southwest/ Central Canada

**LINDA LIEBICH**  
9600 Great Hills Trail, Ste. 150 W  
Austin, TX 78759  
**Phone: (512) 502-3035**  
Fax: (512) 502-9988  
**Email: lindal@concentric.net**

## Southern California/Arizona/ Nevada/Hawaii/Utah

**TARA DUDAS**  
30 Paseo Alba  
San Clemente, CA 92672  
**Phone: (949) 361-4908**  
Fax: (949) 361-1564  
**Email: tara@cpj.com**

## Northern California/Oregon/ Washington/Western Canada

**VICKIE MIYAOKA**  
1935 Mayfield Ave.  
San Jose, CA 95130  
**Phone: (408) 374-9925**  
Fax: (408) 374-9926  
**Email: vmiyaoka@cpj.com**

## Server/Workstation Marketplace Classifieds/Recruitment Ads

**CAROL FLANAGAN** Mgr. Telemarketing Sales  
**Phone: (508) 839-4016**  
**MARY ERICSON**  
**Phone: (508) 839-0720**  
80 Worcester St., Ste. 9  
North Grafton, MA 01536  
Fax: (508) 839-4226  
**Email: caflanag@aol.com**

<i>Reader Inquiry Number</i>	<i>page</i>	<i>Reader Inquiry Number</i>	<i>page</i>
5.....ADIC .....	9	2.....Lightwave .....	1
439..Advantec - ACCI .....	83	330..Michaura Systems .....	76
22....American Power Conversion ..	57	431..Monitor Technology .....	86
348..Ames Sciences .....	86	343..National Data .....	85
6.....Andataco .....	11	366..Network Technologies .....	87
442..Apcon .....	79	340..Nordisk .....	82
402..Applied Digital Systems .....	76	346..Nu Horizon .....	76
313..Arrowfield International .....	80	345..One Source .....	84
316..Atlantic Peripherals .....	86	413..Open Systems Express .....	81
28....ATL Products .....	BC	19....Personal Productivity Tools ..	35
14....Aurora .....	25	23....Polaris .....	58
24....AVCOM .....	63	21....Qualstar .....	53
27....Box Hill .....	C3	3.....Rave .....	5
7.....Bridgepoint Technical .....	12	11....Resilience .....	17
362..Clearpoint Enterprises .....	80	314..Security Computer Sales .....	77
367..Computer Connection .....	86	401..Security Computer Sales .....	79
376..Comtek Computer Systems .....	77	438..Security Computer Sales .....	81
447..Confluent .....	83	24....SharkRack .....	63
29....Consan .....	49	.....Siggraph .....	31
4.....Cycle Computer .....	7	411..Solar Systems .....	83
352..Datalease .....	86	25....Sun Microsystems .....	71
454..Datalease .....	80	26....Sun Microsystems .....	72
455..Datalease .....	83	15....Syntax .....	27
30....Datalink .....	51	10....Tatung .....	15
322..DCG Computers .....	82	8.....Tecmar Technologies .....	13
363..Eli Systems .....	77	20....Terix Computer .....	41
357..Evolving Solutions .....	85	453..The Hyde Company .....	80
404..Express Computer Systems .....	85	420..TriniComp .....	78
372..Express Point .....	84	375..Ultraview .....	81
421..Facet .....	87	320..Universal Capital Funding .....	76
.....Fall Internet World .....	33	.....USENIX .....	29
361..GEAR Software .....	77	331..Virtual Technology .....	82
353..GSH Systems .....	80	428..West Coast Computer Exchange ..	79
422..Gulfcoast Workstation .....	87	324..Western Telematic .....	78
12....Innosoft .....	21	333..Workstations International .....	81
9.....IntraServer Technology .....	14	342..Worldwide Trade Corp .....	84
379..Kingmax .....	84	.....Xerox .....	19
1.....Kingston .....	C2		



DESIGNING A SAN CAN BE COMPLEX.  
TO OUR ENGINEERS IT'S CHILD'S PLAY.

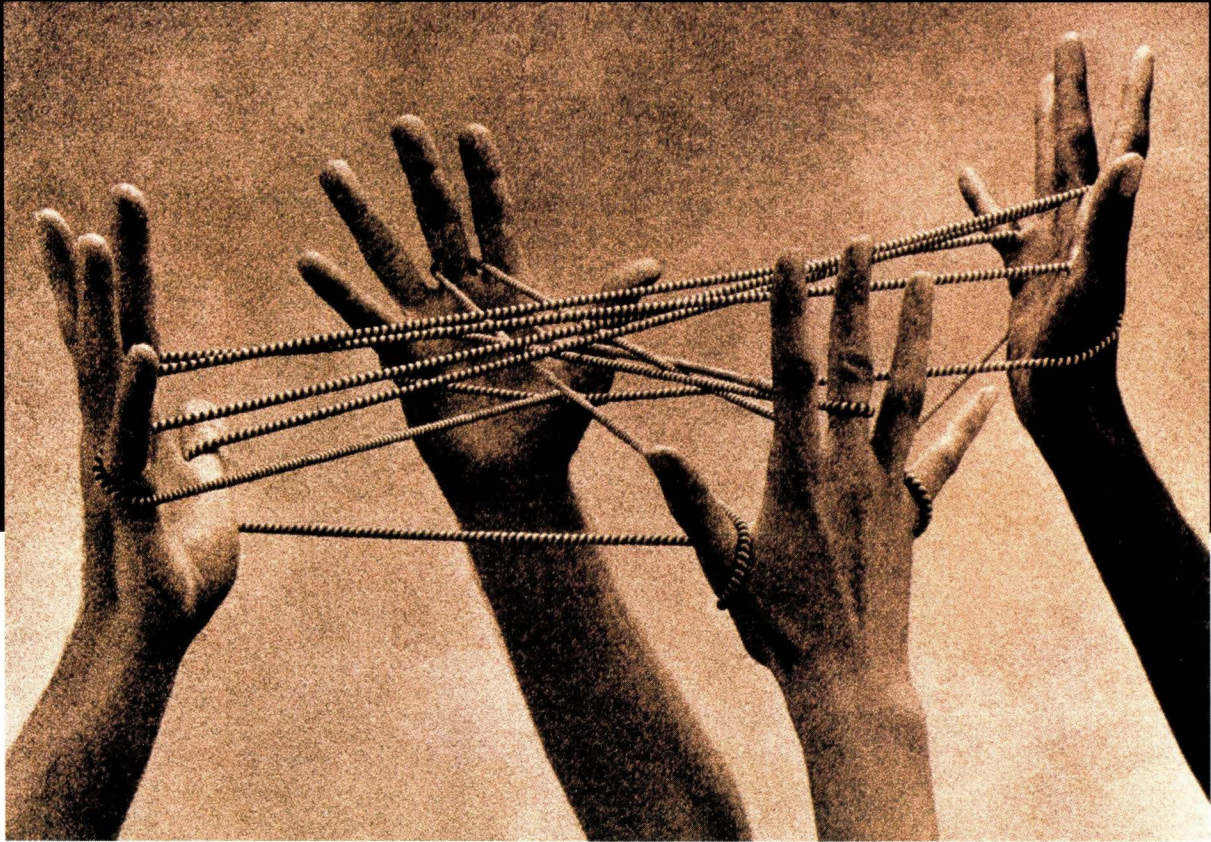

Integrating new technology into your existing environment can be overwhelming. It takes the experience, cooperation and technological know-how of an industry leader like Box Hill to make it work. Our **LAN-less Backup** SAN solution integrates leading-edge technologies from the industry's top storage providers. **LAN-less Backup** takes traffic off your LAN, increasing production throughput,

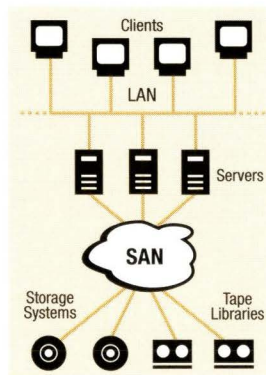

reducing costs, and virtually eliminating the need for a backup window.

Provide your enterprise with the proven increased productivity benefits of **LAN-less Backup** coupled with the speed, flexibility, and dynamic resource allocation advantages of a SAN. To put our solutions to work for you, call Box Hill at 1-800-727-3863, or visit us at [www.boxhill.com/childsplay](http://www.boxhill.com/childsplay).



Circle No. 27

[www.boxhill.com/childsplay](http://www.boxhill.com/childsplay)



The  
**A N A T O M Y**

*Of An Enterprise-Class Library*

**I. The Brain** – Much like "some" human brains, the P3000 has a massive capacity to store and move information. This intelligent library has a native capacity of 11.4 terabytes and blazing performance of 288 gigabytes per hour.

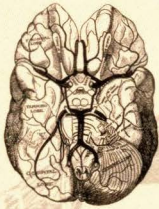

**II. The Eyes** – With local and remote browser GUIs, you'll see the industry's most powerful DLTape library is incredibly easy to use.

**III. The Skeleton** – The human body has two arms and two legs. The P3000 delivers the same high availability (HA) design with redundant AC cords, power supplies and fans. Plus, the power supplies, fans and DLTape drives can be hot-swapped.

**VII. The Spine** – The backbone of the P3000's design is a PCI expansion bus supporting SCSI interface, Fibre Channel, tape array and server PCI cards – "future proofing" your library with a modular upgrade path.

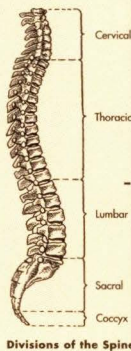

Divisions of the Spine

**VI. The Heart** – The heart of the P3000 is the IntelliGrip precision cartridge handling system which will pick-and-place cartridges for years without skipping a beat.

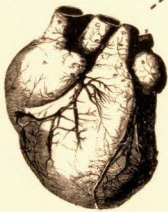

**IV. The Nervous System** – The complex nervous system of the P3000 is designed to support multiple concurrent network, SCSI and fibre channel connections, so each library can be shared by NAS, SAN and direct-connect environments.

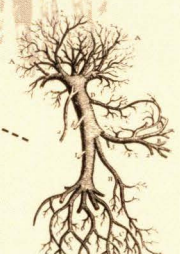

**V. Like a well-tuned body, The P3000's reliability, redundancy, ease of use and modular upgrades all add up to low total cost of ownership (TCO).**

**ATL**  
PRODUCTS  
A Quantum Company



DLTape LIBRARIES DESKTOP TO DATACENTER



ATL Products, Inc. 101 Innovation Drive Irvine, CA 92612-3040  
Phone: (949) 856-7800 Fax: (949) 856-7799 Email: [atpsales@atlp.com](mailto:atpsales@atlp.com) [www.atlp.com](http://www.atlp.com)

©1998 ATL Products, Inc. a Quantum Company. IntelliGrip is a trademark of ATL Products, Inc. Quantum, DLT, DLTape and the DLTape logo are trademarks of Quantum Corporation.