



A Combined DC Voltage Standard and Differential Voltmeter for Precise Calibration Work

An advanced instrument that generates precise, high-resolution dc voltages for calibration work is also a precision differential dc voltmeter with a constant and very high input impedance.

AS MEASURING accuracy improves, so grows the need for higher accuracy in calibration procedures. The ever-expanding usage of high resolution digital voltmeters, for instance, has accentuated the need for calibration instruments that have absolute accuracies of better than 0.01%, along with commensurate stability, linearity, and repeatability. Performance at this level, formerly found only in laboratory grade instruments, now is

wanted in instruments that also have the sturdiness and ease of operation required for everyday workbench service.

Most dc calibrations are performed with three basic instruments: (1) a stable dc voltage source, which can be referenced to a standard cell or some known voltage source for absolute accuracy; (2) a high resolution voltage divider, for reducing the stable source voltage with a linearity suffi-

SEE ALSO:
Frequency comparisons with standard broadcasts based on 'Atomic' time.
p. 8

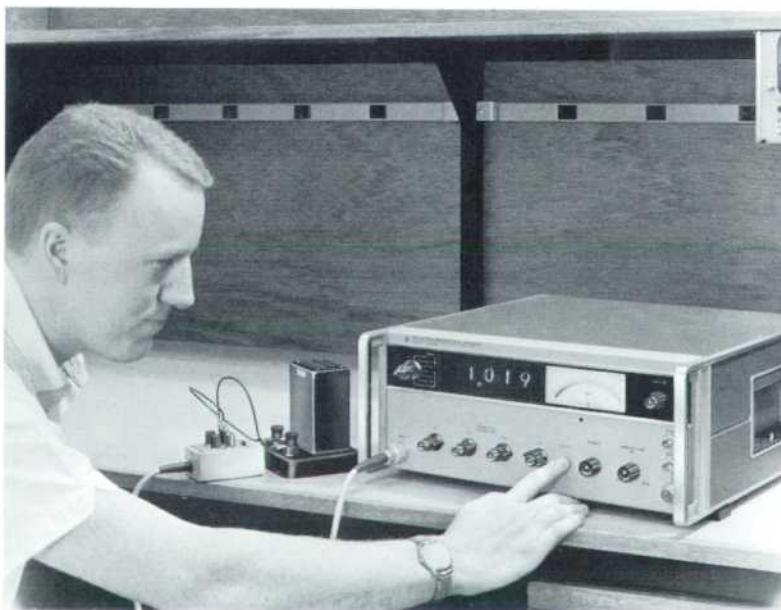

Fig. 1. DC Standard/Differential Voltmeter serves either as a precision source of dc voltages or as a differential voltmeter for making measurements with 6-place resolution. Four most significant digits of reading are displayed on illuminated numerals and two least significant digits are on meter. Exceptionally high input impedance ($>10^9$ ohms on most ranges) in voltmeter mode is maintained regardless of null condition, enabling precision measurements on standard cells, voltage dividers, and other devices sensitive to loading. Both input and output are fully floating and guarded.



Fig. 2. DC Standard/Differential Voltmeter has illuminated numerals to show settings of corresponding decade divider Voltage Set controls. Range switch sets decimal point in display and illuminates corresponding units of measurement (volts or millivolts). Push-button Sensitivity knobs concentric with Voltage Set controls connect meter to corresponding decade of resistive divider and adjust sensitivity of meter accordingly. Operator is able to make differential voltage measurement quickly by depressing Sensitivity push-button for most significant digit first, bringing meter near null with that Voltage Set control, then proceeding with other digits in turn.

ciently greater than the required degree of accuracy; and (3) a sensitive null detector for indicating the voltage differential between the known divider output and an unknown voltage. These basic instruments can be combined to measure or produce dc voltages with accuracies limited only by the linearity of the voltage divider and the accuracy of the reference voltage.

In view of the need for practical instruments for calibration work, a new instrument that combines an accurate voltage reference source, a high precision voltage divider and a null voltmeter into one versatile unit has been developed in the *hp*-Loveland Laboratories. This self-contained instrument functions either as a precision standard voltage source or as an instrument for making accurate dc voltage measurements by the differential technique. Both the dc standard and differential voltmeter functions are provided with 0.01%* absolute accuracy while repeatability and short-term stability are better than 0.001% (10 ppm). The floating and guarded input and the exceptionally high input impedance ($>10^9$ ohms on most

* 0.005% accuracy also available.

ranges) — an impedance that is constant regardless of whether or not the instrument is set for a null — enhances the accuracy of voltage measurements made by the new instrument. Because of its multi-function capability, the instrument is known as a 'DC Standard/Differential Voltmeter'.

As a dc standard voltage source with full-scale ranges of 1, 10, 100, and 1000 volts, the new instrument supplies calibrated voltages from zero to full-scale voltage with 6-place

resolution and with an output current capability of 50 milliamperes up to 500 volts (output capability is 25 watts at higher voltages). A continuous control limits the maximum output current, in the range from 5 to 50 mA, for the protection of delicate components connected to the output.

As a differential voltmeter, the instrument measures voltages with 6-place resolution on basic full-scale ranges from 1 millivolt to 1,000 volts and with null sensitivity as high as 1 μ volt full scale. The accuracy of voltage measurements with the new instrument is little affected by the impedance of the source, as is true of conventional differential voltmeter measurements at null, because the instrument has exceptionally high input impedance ($>10^9$ ohms on 0.1 V and higher ranges). Unlike conventional differential voltmeters, however, the high impedance is maintained *whether or not the instrument is set for a true null*. This characteristic insures accuracy while simplifying operation, especially during measurement of a drifting voltage.

In addition, the high input impedance enables the precise measurement of the voltage of saturated cells, precision potentiometers, or other devices that normally are sen-

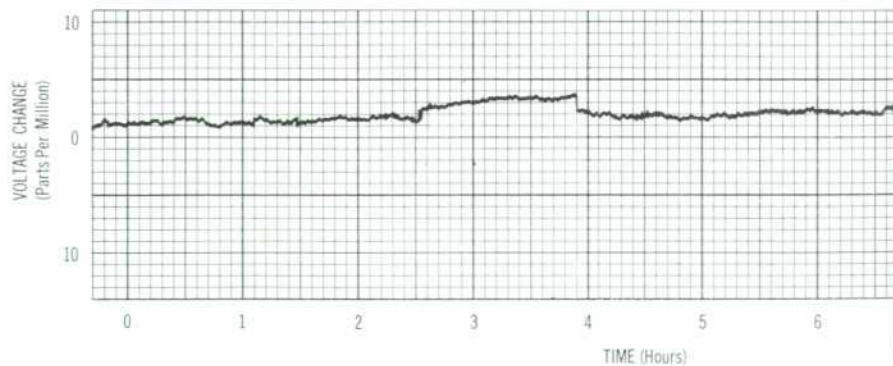

Fig. 3. Ten-hour stability of new DC Standard/Differential Voltmeter is shown by this recording of difference between bank of 9 series-connected standard cells and precision voltage (9.17085 volts) supplied by instrument operating in DC Standard mode. Standard cells were installed in temperature-controlled oil-bath for stability but DC Standard/Differential Voltmeter was subjected to room temperature fluctuations of about 5° F. Record shows typical instrument stability

sitive to small current drains. For example, the input draws only 0.2×10^{-6} coulombs ($0.2 \mu\text{amp-second}$) when first connected to a standard cell. The input is also guarded and floated and thus has high common-mode interference rejection.

The instrument also functions as a high-impedance dc voltmeter, for measuring voltages from 0 to 1,000 volts dc with an end-scale accuracy of $\pm 2\%$, and as a highly-stable dc amplifier that has a gain accuracy of better than $\pm 0.01\%$. It can function additionally as a floating input-floating output precision amplifier by means of a Recorder output that has a ground independent of the other circuits.

The high quality of this instrument, the *-hp-* Model 740A DC Standard/Differential Voltmeter, makes it well-suited for standard labs application. At the same time, its stability in a non-uniform environment and its operating ease make it useful in repair and calibration facilities and on production lines or in any location where testing requires absolute accuracies of $0.01\% \pm 1 \mu\text{volt}$.

INSTRUMENT FUNDAMENTALS

Measurements made by the differential technique are recognized as the most accurate means of relating

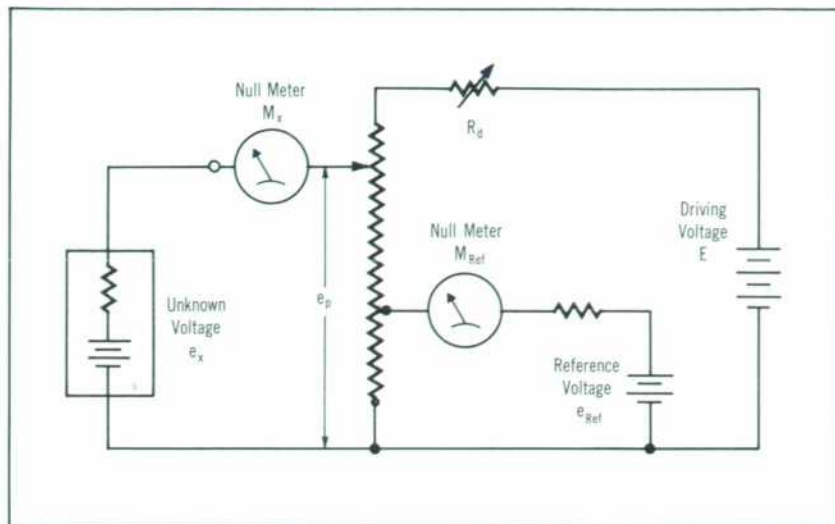

Fig. 4. Classic differential voltage measurement is made by adjusting potentiometer tap to make voltage e_p equal to unknown voltage e_x , as shown by null meter M_x . Potentiometer draws no current from source at null and thus presents infinite input impedance to source, but only at null. Measurement of drifting voltage requires continual readjustment of potentiometer to maintain null. (Potentiometer is calibrated by adjusting R_d to make voltage at reference tap equal to reference voltage.)

an unknown voltage to a known reference. These measurements are made by adjusting the resistive divider to divide down the accurately known reference voltage. The divider is adjusted to the point where the divider output equals the unknown voltage, as shown by the null voltmeter (Fig. 4). Since the resistance ratio of the divider can be determined precisely, the unknown voltage is determined to an accuracy limited only by the accuracies of the

reference voltage and the resistive divider; the meter serves only to indicate any residual differential between the known and unknown.

As shown in the block diagram of Fig. 5, the new DC Standard/Differential Voltmeter has the principal parts of the conventional differential voltmeter, i.e., the stable voltage reference supply, the decade resistive divider, and the null-indicating meter circuit. In a marked departure from conventional differential voltmeter design, however, the circuitry also includes a high-gain, feedback amplifier as an impedance converter between the measured voltage source and the measurement circuits. The amplifier insures that the high input impedance is maintained regardless of whether the instrument is adjusted for a differential null reading or not.

A further advantage provided by the amplifier is that the resistive voltage divider of RANGE 'stick' which enables voltages as high as 1000 volts to be compared to a precision 1-volt reference, may be placed at the output of the ampli-

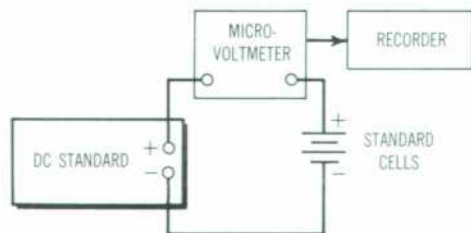
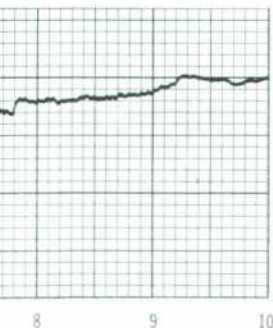

to be considerably better than overall accuracy specification of 100 ppm (0.01%), which allows for errors due to linearity, resolution, and temperature coefficient over a wide range of environmental conditions (0°C to 50°C). With reasonable care and proper calibration techniques, confidence levels of 10 ppm (0.001%) are obtainable under normal laboratory conditions. Temperature coefficient is better than $2 \text{ ppm}/^\circ\text{C}$.

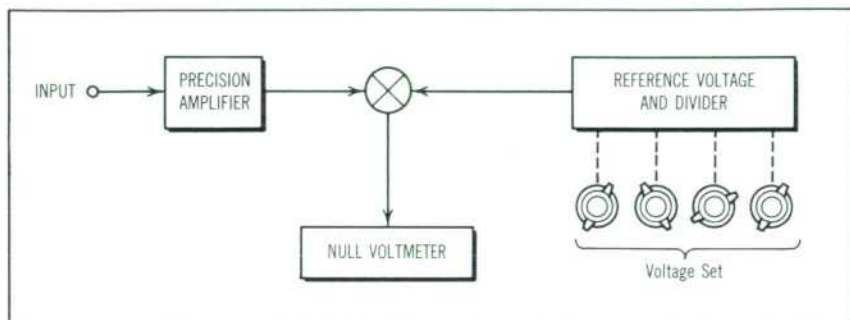

Fig. 5. Simplified diagram of DC Standard/Differential Voltmeter in Differential Voltmeter mode. Precision amplifier isolates measured source from measuring circuits, providing high input impedance on all ranges regardless of null condition.

fier, rather than being in series with the measured voltage source. The isolation provided by the amplifier between the input and the RANGE stick thus enables the instrument to have high input impedance on all ranges.

The amplifier also permits the precision 1-volt source to serve as the reference for calibrated output voltages up to 1000 volts.

INSTRUMENT STABILITY AND ACCURACY

Absolute accuracy in voltage measurements depends primarily on the quality of external standards used for periodic calibration checks and on the overall linearity of the measuring instrument. Stability is most important for retaining accuracy between calibration checks.

The design of the new DC Standard/Differential Voltmeter was directed toward achieving a total instrument stability that depends primarily on the stability of the reference voltage source and the stability of precision wire-wound resistors. Since the amplifier has chopper-stabilization and large orders of negative feedback, amplifier gain is determined mainly by the resistors in the feedback network; normal changes in circuit parameters have virtually no effect.

The wire-wound resistors are an *-hp-* design that achieves high long-term stability. Manufactured in a clean room environment, the resistors are aged and then assembled in sets that have matched temperature coefficients for minimum sensitivity

to temperature. The overall temperature coefficient for the instrument is better than 0.0002% (2 ppm)/ $^{\circ}\text{C}$.

The completed dividers also have trimming resistors that allow the range resistors and the two most significant decades of the resistive divider to be adjusted for ratio accuracies of better than 0.001% .

The heart of the internal reference voltage source is a temperature-compensated zener diode which, with other critical components, is housed in a proportionally-controlled oven. Internal oven temperature is held constant at 80°C within 0.01°C during normal room temperature excursions. The diode voltage changes only about 5 parts per million (0.0005%) during ambient temperature excursions from 0°C to 50°C .

The entire reference supply is pre-aged from 4 to 6 weeks before being placed in the instrument. The stability of the reference voltage is recorded during this time and printed on a chart which is then supplied with the instrument. A typical record, such as that reproduced in Fig. 6, shows a reference stability of better than 10 parts per million (0.001%) for a 4-week period.

Total instrument stability is demonstrated in Fig. 3 which shows the new instrument used as a voltage source bucked against a bank of nine standard cells. The overall 8-hour stability shown here is better than 5 parts per million. Long term stability is better than 15 parts per million (0.0015%) per month.

Overall instrument accuracy is specified at 0.01% . This specification encompasses all the errors arising from deviations in stability, linearity, repeatability, resolution, and temperature coefficient over a wide variety of environmental conditions. With proper calibration techniques and reasonable care, confidence levels of 0.001% (10 ppm) are obtainable under normal laboratory conditions.

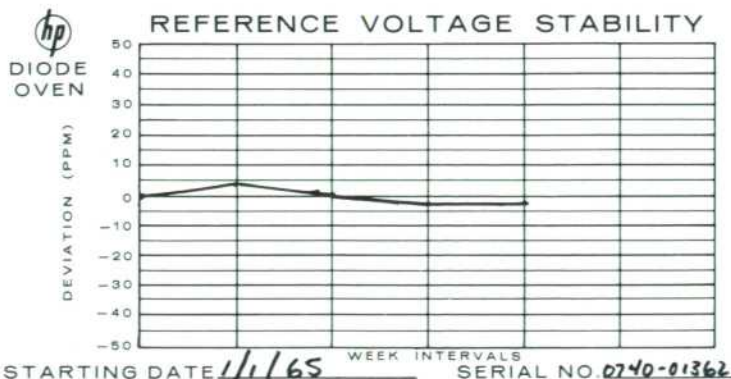

Fig. 6. Stability of typical reference voltage source during pre-installation aging is shown to be much better than 10 ppm per month. Stability record such as this is supplied with instrument in which corresponding reference voltage source is installed. Reference voltage source is responsible for basic accuracy of DC Standard/Differential Voltmeter between calibrations.

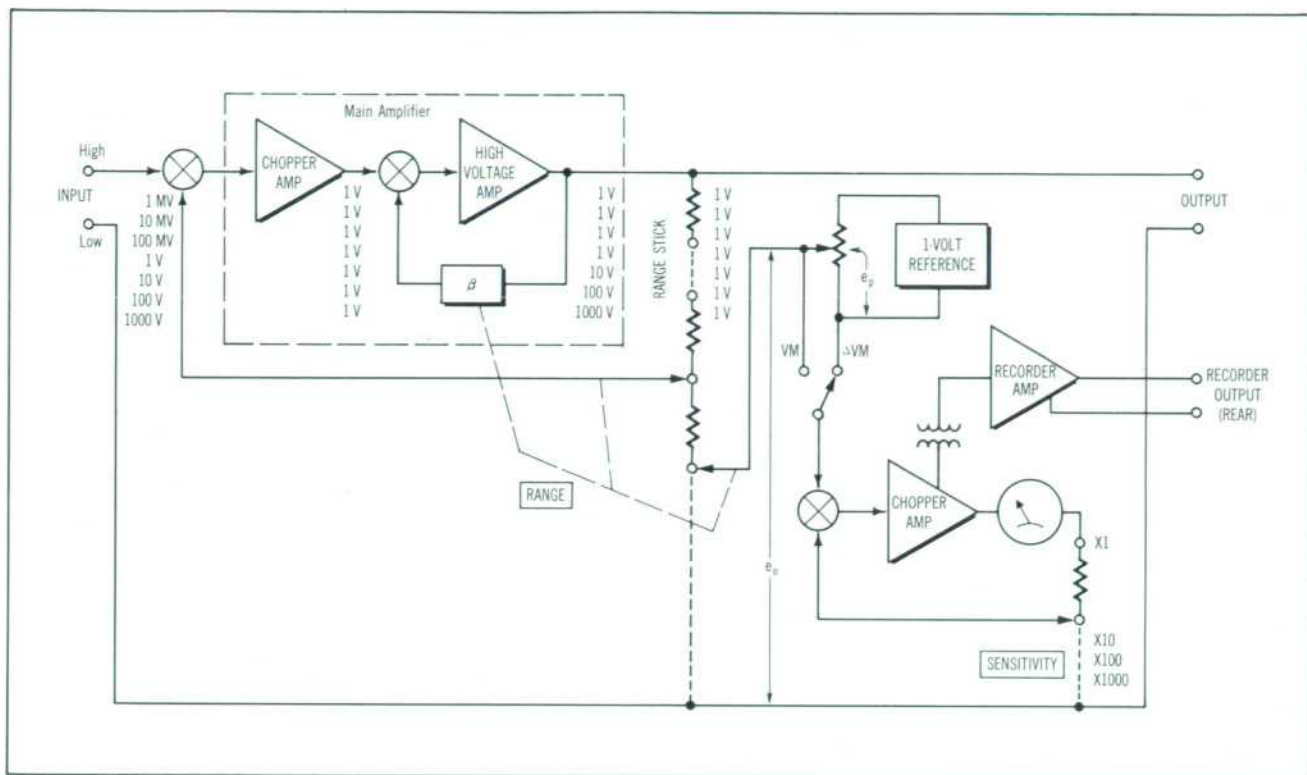

Fig. 7. Detailed block diagram of DC Standard/Differential Voltmeter in differential voltmeter mode. Recorder amplifier is transformer-coupled

to ac portion of chopper amplifier in meter circuit, and is thus able to have output ground terminal independent of other circuit grounds.

SELF ALIGNMENT AND CALIBRATION

A primary objective in the design of the new instrument was to provide the specified accuracy without the use of extensive standards equipment for periodic recalibration. Towards this end, the new instrument includes an internal bridging arrangement which allows alignment of the resistors in the first and second decades of the divider by ratio-matching on a one-to-one basis and alignment of critical range resistors by ratio-matching on a ten-to-one basis to compensate for long-term aging effects. Since the front panel meter serves as a bridge null indicator, and since the bridge circuits are set up by an internal switch, the only external equipment necessary for a complete calibration is a standard cell, or some other known voltage source, and a screwdriver.

To make alignment of the resistive decade dividers practical in terms of the number of adjustments, as well as in cost of components, a

binary-coded divider was developed for the new instrument. These dividers perform electrically the same as the familiar Kelvin-Varley divider but use only four precision resistors per decade instead of eleven. Only 11 adjustments are needed for a complete field calibration.

CIRCUIT DETAILS

A more detailed block diagram of the new instrument is shown in Fig. 7. In the main amplifier, overall feedback of 100 dB is maintained under most operating conditions to assure gain accuracy and also to produce an input impedance greater than 1000 megohms. When a voltage to be measured is placed at the input terminals, the amplifier responds, recreating this voltage at the feedback point, inherently balancing the input to achieve the high input impedance.

The chopper-amplifier uses photoconductors in the modulator and demodulator, as is done in other

—hp— instruments for sensitive measurements^{1,2}. The high-voltage amplifier uses pulse-width modulation to achieve a 1000-volt output capability with solid-state components only. The voltage input to the amplifier controls the width of the internally-generated pulses which drive a step-up transformer, a rectifier, and a filter circuit. Feedback controls the gain of both amplifiers according to the range selected.

Taps on the RANGE stick provide an attenuated voltage of less than 1 volt for the measurement circuits when the selected input range exceeds 1 volt. During differential voltage measurements, the resistive divider is adjusted until the divider output voltage (e_p on the diagram of Fig. 7) is as close to the voltage from the RANGE stick (e_s) as the step-

¹ John M. Cage, "An Increased-Sensitivity Micro Volt-Ammeter Using a Photo-conductive Chopper," *Hewlett-Packard Journal*, Vol. 9, No. 7, Mar., 1958.

² Robert J. Strehlow, "A Solid-State Operational Amplifier of High Stability," *Hewlett-Packard Journal*, Vol. 14, No. 3-4, Nov.-Dec., 1962.

wise divider can allow. The meter circuit responds to any difference between these two voltages, providing 6-place resolution of reading (a ZERO SET control in the meter circuit enables compensation for thermal EMF's in the external circuit).

To serve as a high-impedance voltmeter, the meter amplifier is connected to sense directly the output selected by the RANGE stick, as shown in Fig. 7. This arrangement retains the high impedance input, and speeds up precision measurements of unknown voltages by quickly providing an accurate indication of the

unknown prior to a differential voltmeter measurement.

DC STANDARD

To convert the instrument for use as a DC Standard Voltage Source, internal switching connects the precision voltage source and divider to the amplifier input, as shown in Fig. 8. The output voltage is determined by the resistive divider setting and by the amplifier gain. The voltage at the output sensing terminals, suitably attenuated by the RANGE stick, is returned to the feedback point for comparison with the divider output to insure accuracy. The amplifier

serves two primary functions here: (1) to supply amplification in decade steps, providing precision output voltages up to 1000 volts, and (2) to supply power through its low-impedance output. For the protection of components connected to the output, an OVERLOAD lamp turns on to warn the operator whenever the output reaches the current level selected by the CURRENT LIMIT control.

Front panel switches select the four most significant digits of the voltage output and a VERNIER control selects the least two significant digits, as indicated by the front

SPECIFICATIONS

-hp- MODEL 740A

DC STANDARD/DIFFERENTIAL VOLTMETER

RANGES: 0-1 V, 0-10 V, 0-100 V, 0-1000 V; continuously adjustable on all ranges. Limited to 500 V when + terminal is connected to chassis ground.

ACCURACY:^a
1-V range: 0.01% of indicated setting +0.0002% of full scale.
10-V, 100-V, 1-kV ranges: 0.01% of indicated setting +0.0001% of full scale.

TEMPERATURE COEFFICIENT: <2 ppm +0.0001% of full scale)/°C from 0°C to 50°C.

RESOLUTION: 1 ppm at full scale.

STABILITY:
0.001% of setting +0.0001% of full scale per day.
0.0015% of setting +0.0001% of full scale per month.

OUTPUT CURRENT: 5-50 mA nominal (25 watts max.). Output current limiter continuously variable from 5 to 50 mA (nominal).

LINE REGULATION: <±0.001% of setting ±0.0001% of full scale change for ±10% line voltage change.

REMOTE SENSING: Permits output regulation at point of application.

LOAD REGULATION: <±0.001% ±25 μV change, no load to full load.

NOISE AND HUM:
DC to 1 c/s, 120 dB below full scale;
1 c/s to 10 kc/s, 100 dB below full scale or 150 μV rms; >10 kc/s, 100 dB below full scale or 200 μV rms whichever is greater.

OUTPUT: Floating and guarded. Maximum of 500 V dc may be connected between chassis ground and guard or circuit ground.

OUTPUT CONNECTOR: 7-pin female quick-disconnect front panel connector.

OPERATING TEMPERATURE: 0°C to +50°C.

READOUT: Inline digital display tubes plus individually calibrated taut-band meter.

DC DIFFERENTIAL VOLTMETER

INPUT VOLTAGE RANGES: 1 mV to 1000 V full scale, with null sensitivity down to 1 μV.

ACCURACY: ±0.01% of reading ± 1 μV.

^a 740A with 0.005% accuracy available on special order at additional cost.

RESOLUTION: 0.0002% at full scale, 0.1 μV max.

TEMPERATURE COEFFICIENT: <2 ppm ±1 μV)/°C from 0°C to +50°C.

REPEATABILITY: Better than 0.001% of reading on all ranges.

STABILITY: Better than 0.001% of reading ±2 μV per day; 0.0015% of reading ±5 μV per month.

LINE REGULATION: <±0.001% ±1 μV change for ±10% line voltage change.

INPUT IMPEDANCE: >10⁹ ohms above 10 mV; >10⁸ ohms 1 mV to 10 mV; >10⁷ ohms 1 μV to 1 mV, independent of null.

INPUT: Floating and guarded. Maximum of 500 V dc may be connected between chassis ground and guard or circuit ground.

INPUT CONNECTOR: 3-pin female quick-disconnect front panel connector.

AC COMMON MODE REJECTION: >120 dB at 60 c/s.

SUPERIMPOSED AC NOISE REJECTION:
Above 100 c/s: <0.005% change for 100% (25 volts max.) ac noise superimposed on dc signal.

Above 50 c/s: <0.005% change for 25% (25 volts max.) ac noise superimposed on dc signal.

READOUT: 4 inline digital display tubes plus individually calibrated taut-band meter.

DC HIGH IMPEDANCE VOLTMETER

INPUT VOLTAGE RANGES: 1 μV full scale to 1000 V full scale dc.

ACCURACY: ±2% end scale ±0.1 μV.

INPUT IMPEDANCE: Same as ΔVM.

READOUT: Individually-calibrated taut-band meter.

AMPLIFIER

VOLTAGE GAIN:
60 dB on 1 mV range.
40 dB on 10 mV range.
20 dB on 100 mV range.
Unity above 100 mV range.

GAIN ACCURACY: ±0.01%.

OUTPUT: 50 mA nominal (25 watts max.).

GAIN STABILITY: Better than 0.001% ±2 μV per day referred to input.

BANDWIDTH: DC to 0.1 c/s.

AC COMMON MODE REJECTION: Same as ΔVM.

LOAD REGULATION: Same as DC Standard.

LINE REGULATION: Same as ΔVM.

SUPERIMPOSED AC NOISE REJECTION: Same as ΔVM.

INPUT IMPEDANCE: Same as ΔVM.

NOISE:

DC to 1 c/s:

<0.1 μV referred to input at 60 dB gain.

<0.2 μV referred to input at 40 dB gain.

<2.0 μV referred to input at 20 dB gain.

At Unity gain (1 V range and above), same as DC Standard.

Above 1 c/s: Same as DC Standard 1 volt range and above (Constant on 1 volt range and below).

ISOLATED RECORDER OUTPUT: Recorder output voltage directly proportional to meter deflection, 120 dB gain (max.), depends on range; 1 volt nominal with 1 k ohm load. Floating and isolated from circuit and chassis grounds. Noise and drift is <0.5% of output.

GENERAL

POWER SUPPLY: 115 or 230 V ±10%, 50 c/s to 1000 c/s, 125 watts max.

DIMENSIONS: 7" high x 16 3/4" wide x 18 3/4" long (177.8 x 425 x 527 mm). Rack Mount Kit furnished with instrument.

WEIGHT: Net, 47 lbs.; shipping, 60 lbs.

PRICE: \$2,350.00.

ACCESSORIES FURNISHED:

11054A INPUT CABLE: Four banana jacks mounted on terminal box with 3-ft. cable and mating connector. Terminals include positive and negative input, circuit guard, and chassis ground. Switch allows reduction of input impedance to 2 megohms. Maximum of 500 volts may be connected between chassis ground and guard or circuit ground.

11055A OUTPUT CABLE: Six banana jacks mounted on terminal box with 3-ft. cable and mating connector. Terminals include positive and negative output, positive and negative remote sense, circuit guard and chassis ground. Maximum of 500 volts dc may be connected between chassis ground and guard or circuit ground.

Prices f.o.b. factory.

Data subject to change without notice.

panel meter. The RANGE switch sets the decimal point in the readout and selects the amplification factor, providing four full-scale ranges from 1 to 1000 volts in decade steps. Care has been taken in the design of the switching circuits to insure that there is no possibility of a voltage "run-away" during a range change. Precise voltages to be used for testing or calibrating voltmeters, amplifiers, recorders or other devices are quickly selected.

PRECISION DC AMPLIFIER

The instrument can be used as a dc power amplifier, in either the Δ VM or VM modes, by connecting the source to the input connectors and taking the output from the connectors that normally supply the calibrated voltages. It is thus possible to augment the capabilities of a standard cell, for example, by



Fig. 9. Connections to and from new instrument are made through connector boxes on detachable cables. Input connector box has two guarded and floating input connectors and connections to guard shield and circuit ground. Switched 2-megohm resistor provides discharge path for input capacitance (low leakage of high-impedance input retains charge for some time after removal of source).

Output connector box has two output connectors completely isolated from chassis and power grounds, one connector for guard and one for chassis ground, and two sense connectors for feedback circuit. Sense leads may be strapped to output connectors, or connected to output leads at point of delivery to avoid errors caused by IR drop in output leads. Box also has warning lamp that turns on whenever voltage supplied to output connector is greater than 120 volts.

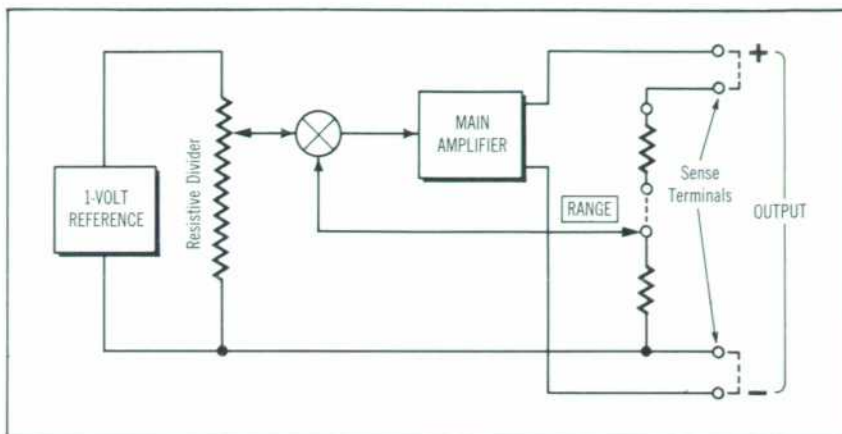

Fig. 8. Block diagram of DC Standard/Differential Voltmeter in DC Standard mode. Setting of resistive divider determines basic voltage and setting of Range switch establishes decade multiplying factor. Separate sense terminals enable remote sensing of output voltage.

using the amplifier as a precisely-controlled impedance converter to provide power amplification.

The available gain depends on the selected voltage range. The instrument functions as a unity-gain amplifier on the 1-volt and higher ranges but on lower ranges, the gain increases in 20-dB steps to a maximum of 60 dB on the 1-mV range. Gain accuracy is $\pm 0.01\%$ and stability is 0.001% per day after warm-up. Bandwidth is dc to 0.1 cps and maximum output current is 50 mA (to 500 volts).

By taking the output from a rear-panel RECORDER connector, which is fed from the precision meter amplifier, the instrument supplies as much as 120 dB of voltage gain (depending on range), 60 dB in the main amplifiers and 60 dB in the meter and recorder amplifiers. The RECORDER output is proportional to meter deflection and at full-scale meter deflection, has a 1-volt maximum output.

ACKNOWLEDGMENTS

The design and development of the 740A included the suggestions and ideas of many individuals. The development group consisted of Charles D. Platz, John Boatwright, Donald A. Wick, Gale C. Hamelwright, Lawrence E. Linn, Dan K.

Merrell, and the undersigned. Contribution in the design of magnetic components by Ray C. King is gratefully acknowledged. Also the ideas and suggestions of Marco Negrete were particularly valuable throughout the development program.

—Robert E. Watson

DESIGN LEADER



Robert E. Watson

Bob Watson joined the -hp- Loveland Laboratories as a development engineer in 1961 following two years in atmospheric and ionospheric research at a university-affiliated research laboratory. He holds both a BSEE and an MSEE from the University of Utah and is a member of Eta Kappa Nu, Tau Beta Pi, and Sigma Xi. Bob is now a group leader in the -hp- Loveland Laboratories with responsibility for dc differential voltmeters, low-level dc voltmeters, and dc standards.

PHASE COMPARISONS WITH LF STANDARD BROADCASTS CONTROLLED BY 'ATOMIC TIME'

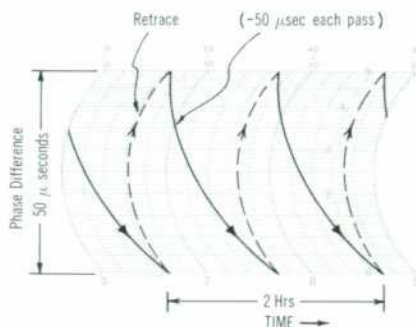

Fig. 1. Idealized recorder trace shows accumulation of $-100 \mu\text{sec}$ phase change ($-50 \mu\text{sec}$ per pass) in 2 hrs. Frequency offset of local standard frequency with respect to WWVB carrier therefore is $-100 \mu\text{sec}/2 \times 60 \times 60 \times 10^6 \mu\text{sec} \approx -140 \times 10^{-10}$, interpreted as $+10 \times 10^{-10}$ offset with respect to UT2.

As discussed in these pages recently, the carrier frequency of NBS Low Frequency Standard Broadcast Station WWVB (60 kc/s) has been increased by 150 parts in 10^{10} (3.24 cycles per hour) to permit the carrier to be maintained without offset with respect to the U. S. Frequency Standard.¹ Accordingly, the carrier is now referenced to the recently-adopted International Unit of Time (Atomic Time), rather than to Universal Time as it was previously.

If the frequency of a local frequency standard is adjusted $+150$ parts in 10^{10} to bring it into agreement with Atomic Time, phase comparisons for calibrating the local standard with respect to WWVB can be made in the usual manner with the *-hp-* Model 117A VLF Phase Comparator.²

However, for those who prefer to maintain their local standard with respect to UT2, a time scale widely used for navigation and other phenomena based on the earth's rotation on its own axis, an AT-to-UT2 Translator has been developed for

the VLF Phase Comparator. This device* is a motor-driven-synchro-resolver that continuously retards the phase of the received WWVB carrier within the Comparator to derive the equivalent of a UT2-referenced frequency. The Translator is supplied with proper gear ratios for the offset in effect at the time of installation and additional gear sets are available for other offsets.

The Translator enables phase comparisons to be made between WWVB and a UT2-referenced standard with the accuracy and convenience provided by recorder traces having close to zero frequency offset. Instabilities in the local power line frequency may affect comparisons made with the translator, but typical deviations in power line frequencies in the U. S. cause errors of translation of only 1.5×10^{-11} . Over long periods, of course, power-line frequency variations usually average out close to zero.

When a UT2-referenced frequency standard is compared with WWVB by a VLF Phase Compar-

**-hp-* Part No. 00117-9027.

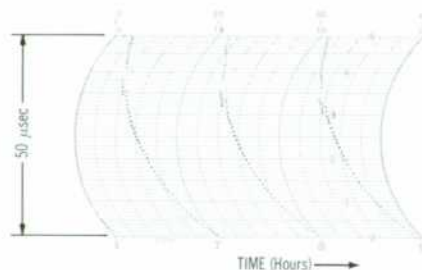

Fig. 2. Actual record made by *-hp-* Model 117A VLF Phase Comparator of locally-generated UT2-referenced frequency against WWVB. Gaps in each pass are caused by once-an-hour 45° ($2.083 \mu\text{sec}$) phase shifts introduced into WWVB carrier for identification purposes. Identifying phase shifts, which last five minutes, show up as 2- μsec displacement of 5-dot line segment.

tor that does not have a Translator, the phase record is accurately evaluated by determining the phase change accumulated over a definite period of time. The offset is readily computed as the ratio of phase change, measured in microseconds, to elapsed time (Fig. 1). This method, applicable to any offset, is valid since the fractional time error is the same as fractional frequency error ($|\Delta t/T| = |\Delta f/F|$).

TIME PHASE ADJUSTMENT

Also noted previously,¹ the 1-second time pulses that have been added to WWVB are readjusted periodically to maintain them within about 0.1 second of UT2 time. The readjustments are necessary, of course, because UT2 time differs from Atomic time by about 0.0013 second/day, a rate of change that varies slightly because of unpredictable changes in the speed of the earth's rotation. Accordingly, the WWVB time signals were retarded 200 ms at 0000 UT April 1, 1965 (7 pm EST of March 31).

Time signals broadcast by NBS high-frequency stations WWV and WWVH were retarded 0.1 second at 0000 UT on March 1, 1965 (7 pm

EST of Feb. 28). These time signals continue to be maintained with respect to UT2 time but, because of the previously-mentioned changes in the earth's rotation speed, must be readjusted periodically.

TONE TRANSMISSIONS CHANGED

A recent questionnaire indicated that few users need the single-sideband feature of transmissions of the 400 and 600 c/s audio tones on WWV. Therefore, to simplify station operation, single-sideband transmissions were discontinued March 1, 1965, and the audio tones are now broadcast on all carrier frequencies by double-sideband modulation.

On June 1, 1965, WWVH will add transmissions on a 2.5 Mc/s carrier using the same modulation format as on other frequencies.

¹ "Atomic Time Adopted for WWVB," *Hewlett-Packard Journal*, Vol. 16, No. 6, Feb. 1965.

² Dexter Hartke, "A VLF Comparator for Relating Local Frequency to U. S. Standards," *Hewlett-Packard Journal*, Vol. 16, No. 2, Oct., 1964.